



... eine starke Verbindung

IZJAVA O SVOJSTVIMA

DoP br. MKT-1.1-900_hr

- ✧ **Jedinstvena identifikacijska oznaka vrste proizvoda:** **Wedge sidro BZ3 / BZ3 A4 / BZ3 HCR**
- ✧ **Namjena/namjene:** Mehaničko sidro za sidrenje u betonu, vidi Prilog/Annex B
- ✧ **Proizvođač:** MKT Metall-Kunststoff-Technik GmbH & Co.KG
Auf dem Immel 2
67685 Weilerbach
- ✧ **Sustav ili sustavi ocjenjivanja i provjere stalnosti svojstava građevnog proizvoda:** 1
- ✧ **Europski dokument za ocjenjivanje:** **EAD 330232-01-0601**
Europska tehnička ocjena: **ETA-19/0619, 26.02.2020**
Tijelo za tehničko ocjenjivanje: DIBt, Berlin
Prijavljeno tijelo/prijavljena tijela: NB 2873 – Technische Universität Darmstadt
- ✧ **Objavljena svojstva:**

Bitnih značajka	Svojstva
Temeljni zahtjevi za građevine (BWR 1)	
Minimalna udaljenost ruba i minimalna udaljenost od centra	Prilog / Annex B3
Karakteristični otpori pod vlačnim opterećenjem (statički i kvazi-statički efekti)	Prilog / Annex C1, C2
Karakteristični otpori pod poprečnim naprezanjem (statički i kvazi-statički efekti)	Prilog / Annex C3
Karakteristični otpori za seizmičke performanse kategorije C1 + C2	Prilog / Annex C4
Pomaci	Prilog / Annex C6, C7
Trajnost	Prilog / Annex B1
Sigurnost u slučaju požara (BWR 2)	
Ponašanje požara	Klasa A1
Otpornost na vatru	Prilog / Annex C5

Izvedba gore navedenog proizvoda je deklarirana izvedba / izvedba. Gore navedeni proizvođač jedini je odgovoran za sastavljanje izjave o učinkovitosti u skladu s Uredbom (EU) br. 305/2011.

Za proizvođača i u njegovo ime potpisao:

Stefan Weustenhagen
(generalni direktor)
Weilerbach, 01.01.2021

p.p. 
Dipl.-Ing. Detlef Bigalke
(Voditelj razvoja proizvoda)



Izvornik ove izjave o izvedbi pisan je na njemačkom jeziku. U slučaju odstupanja u prijevodu vrijedi njemačka verzija.

Specifications of intended use

Wedge Anchor	BZ3 / BZ3 A4 / BZ3 HCR			
	M8	M10	M12	M16
Static or quasi-static action	✓			
Seismic performance categories C1 and C2	✓			
Fire exposure	R30 / R60 / R90 / R120			
Variable, effective anchorage depth	35 mm to 90 mm	40 mm to 100 mm	50 mm to 125 mm	65 mm to 160 mm

Base materials:

- Cracked or uncracked concrete
- Reinforced or unreinforced normal weight concrete according to EN 206: 2013 + A1:2016
- Strength classes C20/25 to C50/60 according to EN 206: 2013 + A1:2016

Use conditions (Environmental conditions):

- Structures subject to dry internal conditions: **BZ3, BZ3 A4, BZ3 HCR**
- For all other conditions according to EN 1993-1-4:2015-10 corresponding to corrosion resistance classes:
 - according to Annex A, Table A.3: CRC I - III **BZ3 A4, BZ3 HCR**
 - according to Annex A, Table A.3: CRC IV, V **BZ3 HCR**

Design:

- Anchorages are designed under the responsibility of an engineer experienced in anchorages and concrete work
- Verifiable calculation notes and drawings are prepared taking account of the loads to be anchored. The position of the fastener is indicated on the design drawings (e.g. position of the fastener relative to reinforcement or to supports, etc.)
- Design method EN 1992-4:2018 and Technical Report TR 055

Installation:

- Hole drilling by hammer drill bit or vacuum drill bit
- Use of the fastener only as supplied by the manufacturer without exchanging the components of the fastener (exception: when using the cap nut HM)
- Optionally, the annular gap between fixture and stud of the BZ3 can be filled to reduce the hole clearance. For this purpose, the filling washer (annex A3) must be used in addition to the supplied washer. For filling use high-strength mortar with compressive strength $\geq 40\text{N/mm}^2$.

Wedge Anchor BZ3 / BZ3 A4 / BZ3 HCR

Intended use
Specifications

Annex B1

Table B1: Installation parameters

Anchor size			BZ3 / BZ3 A4 / BZ3 HCR				
			M8	M10	M12	M16	
Nominal drill hole diameter	d_0	[mm]	8	10	12	16	
Cutting diameter of drill bit	$d_{cut} \leq$	[mm]	8,45	10,45	12,5	16,5	
Minimum effective anchorage depth	$h_{ef,min}$	[mm]	35	40	50	65	
Maximum effective anchorage depth	$h_{ef,max}$	[mm]	90	100	125	160	
Depth of drill hole	$h_0 \geq$	[mm]	$h_{ef} + 8$	$h_{ef} + 9$	$h_{ef} + 10$	$h_{ef} + 14$	
	$h_1 \geq$	[mm]	$h_{ef} + 10$	$h_{ef} + 11$	$h_{ef} + 13$	$h_{ef} + 17$	
Diameter of clearance hole in the fixture ¹⁾	$d_f \leq$	[mm]	9	12	14	18	
Projection after anchor has been inserted for installing with cap nut HM (according to Annex B5)	C	[mm]	10,5	12,5	16,0	19,5	
Installation torque	BZ3	T_{inst}	[Nm]	15	40	60	110
	BZ3 A4 / HCR	T_{inst}	[Nm]	15	40	55	100

¹⁾ For larger diameters of clearance hole in the fixture, see EN 1992-4, chapter 6.2.2.2

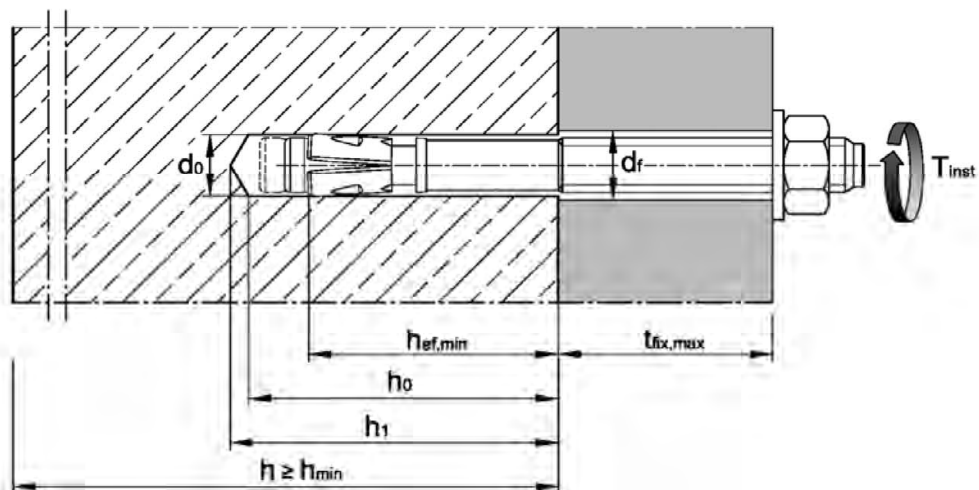

Setting gauge for installation with cap nut HM

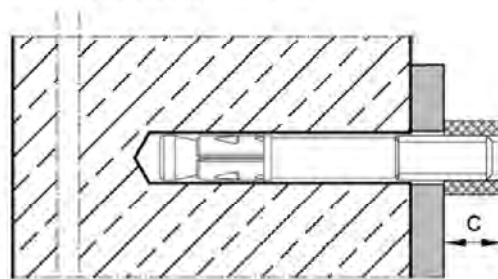

C [mm] :
Projection after anchor has been inserted for installing with cap nut HM or height of setting gauge (see Table B1 and Annex B6).

Wedge Anchor BZ3 / BZ3 A4 / BZ3 HCR

Intended use
Installation parameters

Annex B2

Table B2: Minimum thickness of concrete member, minimum spacings, edge distances and required area

Anchor size				BZ3 / BZ3 A4 / BZ3 HCR				
				M8	M10	M12	M16	
Minimum member thickness depending on h_{ef}	$h_{min} \geq$	[mm]	max (1,5 · h_{ef} ; 80)		max (1,5 · h_{ef} ; 100)		max (1,5 · h_{ef} ; 120)	
Minimum edge distances and spacings								
Minimum edge distance	c_{min}	[mm]	40	45	55	65		
Minimum spacings	s_{min}	[mm]	35	40	50	65		
Projected required area $A_{pr,req}$								
Projected required area	BZ3	cracked concrete	$A_{pr,req}$	[mm ²]	13 900	23 700	31 500	42 300
		uncracked concrete	$A_{pr,req}$	[mm ²]	22 500	34 700	41 300	50 200
	BZ3 A4, BZ3 HCR	cracked concrete	$A_{pr,req}$	[mm ²]	16 900	25 900	29 800	44 300
		uncracked concrete	$A_{pr,req}$	[mm ²]	19 700	35 700	35 300	54 800
<p>The edge distances and spacings shall be selected in steps of 5 mm. In combination with variable anchorage depths and member thicknesses, the following equation must be fulfilled:</p>								
$A_{pr,req} \leq A_{pr,ef}$				$A_{pr,req}$ Projected required area $A_{pr,ef}$ Projected effective area (acc. to Table B4)				

Table B3: Applicable concrete thickness h_{sp} and area A_{sp} to determine characteristic edge distance $c_{cr,sp}$

Anchor size				M8	M10	M12	M16
Applicable concrete thickness	BZ3 BZ3 A4, BZ3 HCR	h_{sp}	[kN]	$\min(h ; h_{ef} + 1,5 \cdot c \cdot \sqrt{2})$			
Area to determine $c_{cr,sp}$ ¹⁾	BZ3	A_{sp}	[mm ²]	$\frac{N_{Rk,sp}^0 - 2,573}{0,000436}$	$\frac{N_{Rk,sp}^0 + 2,040}{0,000693}$	$\frac{N_{Rk,sp}^0 + 3,685}{0,000692}$	$\frac{N_{Rk,sp}^0 + 3,738}{0,000875}$
	BZ3 A4, BZ3 HCR	A_{sp}	[mm ²]	$\frac{N_{Rk,sp}^0 + 4,177}{0,000862}$	$\frac{N_{Rk,sp}^0 + 7,235}{0,000967}$	$\frac{N_{Rk,sp}^0 + 7,847}{0,000951}$	$\frac{N_{Rk,sp}^0 + 11,415}{0,000742}$

¹⁾ with $N_{Rk,sp}^0$ in kN

Wedge Anchor BZ3 / BZ3 A4 / BZ3 HCR

Intended use
 Minimum spacings and edge distances
 Required area and applicable concrete thickness

Annex B3

Table B4: Projected effective area $A_{pr,ef}$ to determine spacings and edge distances



Member thickness: $h > h_{ef} + 1,5 \cdot c$			
Effective anchorage depth $h_{ef} < 1,5 \cdot c$		Effective anchorage depth $h_{ef} \geq 1,5 \cdot c$	
anchor group with $s \geq 3 \cdot c$ or single anchor			
$A_{pr,ef} = 2 \cdot (3 \cdot c) \cdot (1,5 \cdot c + h_{ef})$ [mm ²]		$A_{pr,ef} = 2 \cdot (3 \cdot c) \cdot (3 \cdot c)$ [mm ²]	
Anchor group ($s < 3 \cdot c$)			
$A_{pr,ef} = (3 \cdot c + s) \cdot (1,5 \cdot c + h_{ef})$ [mm ²]		$A_{pr,ef} = (3 \cdot c + s) \cdot (3 \cdot c)$ [mm ²]	
Member thickness: $h \leq h_{ef} + 1,5 \cdot c$			
Effective anchorage depth $h_{ef} \leq 1,5 \cdot c$		Effective anchorage depth $h_{ef} > 1,5 \cdot c$	
anchor group with $s \geq 3 \cdot c$ or single anchor			
$A_{pr,ef} = 2 \cdot (3 \cdot c) \cdot h$ [mm ²]		$A_{pr,ef} = 2 \cdot (3 \cdot c) \cdot (h - h_{ef} + 1,5 \cdot c)$ [mm ²]	
Anchor group ($s < 3 \cdot c$)			
$A_{pr,ef} = (3 \cdot c + s) \cdot h$ [mm ²]		$A_{pr,ef} = (3 \cdot c + s) \cdot (h - h_{ef} + 1,5 \cdot c)$ [mm ²]	
<p>If the area $A_{pr,ef}$ is trimmed by lateral edges ($c_2 < 1,5 \cdot c$), calculate the area actually present. The spacings and edge distances shall be rounded to 5 mm.</p>			

Wedge Anchor BZ3 / BZ3 A4 / BZ3 HCR

Intended use
Projected effective area to determine spacings and edge distances

Annex B4

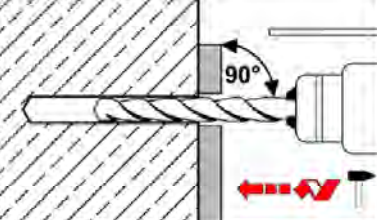
Installation instructions

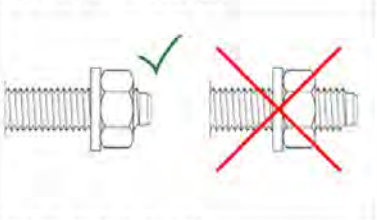
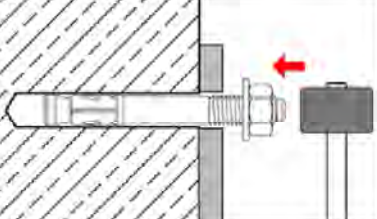
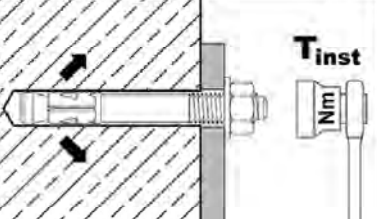

1		<p>Drill hole perpendicular to concrete surface. If using a vacuum drill bit, proceed with step 3.</p>
2		<p>Blow out dust. Alternatively vacuum clean down to the bottom of the hole.</p>
3		<p>Check position of nut and washer.</p>
4		<p>Drive in fastener.</p>
5		<p>Apply installation torque T_{inst}.</p>

Wedge Anchor BZ3 / BZ3 A4 / BZ3 HCR

Intended use
Installation instructions

Annex B5

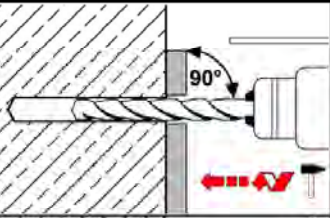
Installation with cap nut HM

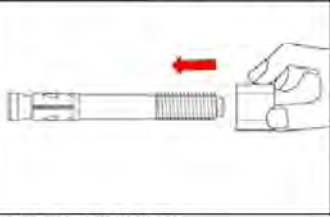
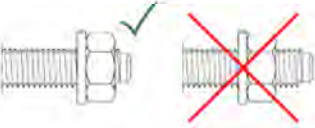
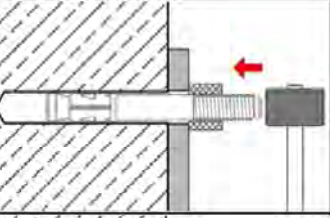
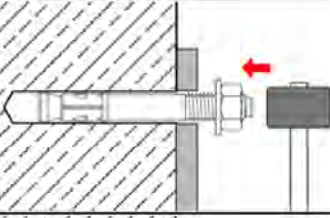
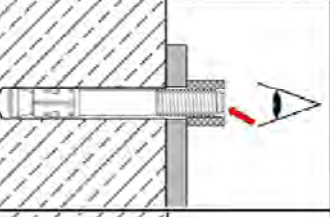
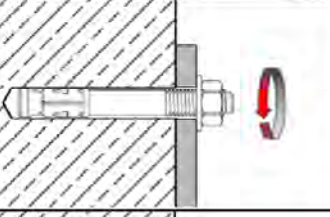
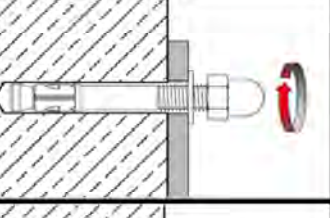
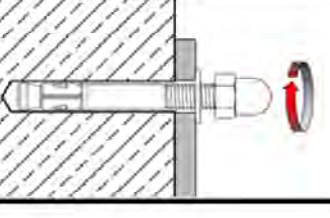
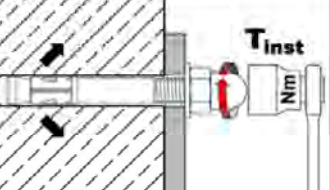

1		<p>Drill hole perpendicular to concrete surface. If using a vacuum drill bit, proceed with step 3.</p>	
2		<p>Blow out dust. Alternatively vacuum clean down to the bottom of the hole.</p>	
<p style="text-align: center;">Installation <u>with</u> setting gauge</p>		<p style="text-align: center;">Installation <u>without</u> setting gauge</p>	
3		<p>Remove nut and washer. Attach setting gauge.</p>	 <p>Check position of nut.</p>
4		<p>Drive in fastener until end of the anchor is level with setting gauge.</p>	 <p>Drive in fastener</p>
5		<p>Check excess length of the anchor, remove setting gauge.</p>	 <p>Remove nut.</p>
6		<p>Screw on washer and cap nut.</p>	 <p>Screw on cap nut</p>
7		<p>Apply installation torque T_{inst}.</p>	

Wedge Anchor BZ3 / BZ3 A4 / BZ3 HCR

Intended use
Installation instructions with cap nut

Annex B6

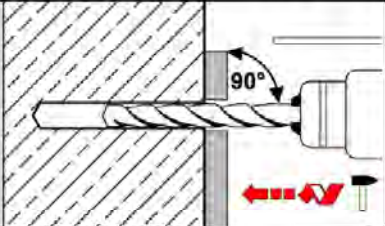
Installation instructions with filling of annular gap

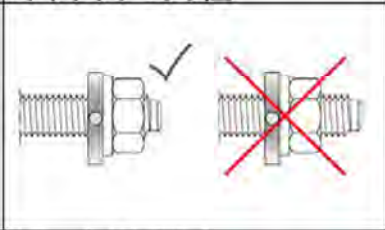
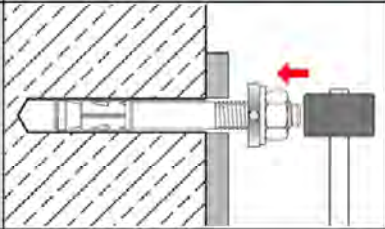
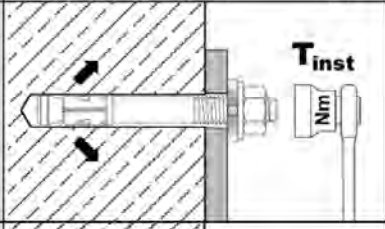
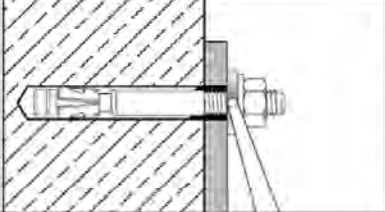
1		<p>Drill hole perpendicular to concrete surface. If using a vacuum drill bit, proceed with step 3.</p>
2		<p>Blow out dust. Alternatively vacuum clean down to the bottom of the hole.</p>
3		<p>Fit the filling washer additionally to the fastener. Check position of nut and washer.</p>
4		<p>Drive in fastener.</p>
5		<p>Apply installation torque T_{inst}.</p>
6		<p>Fill the annular gap between anchor and fixture with mortar (compressive strength $\geq 40 \text{ N/mm}^2$). Use enclosed reducing adapter. Observe the processing information of the mortar! The annular gap is completely filled, when excess mortar seeps out.</p>

Wedge Anchor BZ3 / BZ3 A4 / BZ3 HCR

Intended use
Installation instructions with filling of annular gap

Annex B7

Table C1: Characteristic values for tension loads under static and quasi-static action, BZ3 zinc plated

Fastener size			BZ3 (zρ)			
			M8	M10	M12	M16
Installation factor	γ_{inst}	[-]	1,0			
Steel failure						
Characteristic resistance	$N_{Rk,s}$	[kN]	19,8	30,4	44,9	79,3
Modulus of elasticity	E_s	[N/mm ²]	210.000			
Partial factor	γ_{Ms}	[-]	1,5			
Pull-out						
Characteristic resistance in cracked concrete C20/25	$N_{Rk,p,cr}$	[kN]	9,5	15	22	30
Increasing factor for $N_{Rk,p,cr}$	ψ_C	[-]	$\left(\frac{f_{ck}}{20}\right)^{0,439}$	$\left(\frac{f_{ck}}{20}\right)^{0,265}$	$\left(\frac{f_{ck}}{20}\right)^{0,5}$	$\left(\frac{f_{ck}}{20}\right)^{0,339}$
Characteristic resistance in uncracked concrete C20/25	$N_{Rk,p,ucr}$	[kN]	14	24	30	50
Increasing factor for $N_{Rk,p,ucr}$	ψ_C	[-]	$\left(\frac{f_{ck}}{20}\right)^{0,489}$	$\left(\frac{f_{ck}}{20}\right)^{0,448}$	$\left(\frac{f_{ck}}{20}\right)^{0,5}$	$\left(\frac{f_{ck}}{20}\right)^{0,203}$
Splitting						
Characteristic resistance	$N_{Rk,sp}^0$	[kN]	$\min(N_{Rk,p}; N_{Rk,c}^0)$			
Characteristic edge distance ²⁾	$c_{cr,sp}$	[mm]	$\frac{A_{sp} + 0,8 \cdot (h_{sp} - h_{ef})^2}{(3,41 \cdot h_{sp} - 0,59 \cdot h_{ef})}$			
Characteristic spacing	$s_{cr,sp}$	[mm]	$2 \cdot c_{cr,sp}$			
Concrete cone failure						
Minimum, effective anchorage depth	$h_{ef,min}$	[mm]	35 ¹⁾	40	50	65
Maximum, effective anchorage depth	$h_{ef,max}$	[mm]	90	100	125	160
Characteristic edge distance	$c_{cr,N}$	[mm]	$1,5 \cdot h_{ef}$			
Characteristic spacing	$s_{cr,N}$	[mm]	$2 \cdot c_{cr,N}$			
Factor k_1	cracked concrete	$k_{cr,N}$	7,7			
	uncracked concrete	$k_{ucr,N}$	11,0			

¹⁾ Fastenings with anchorage depth $h_{ef} < 40$ mm are restricted to the use of structural components which are statically indeterminate and subject to internal exposure conditions only.

²⁾ Applicable concrete thickness h_{sp} and area A_{sp} to determine characteristic edge distance $c_{cr,sp}$ according to Table B3

³⁾ $N_{Rk,c}^0$ according to EN 1992-4:2018

Wedge Anchor BZ3 / BZ3 A4 / BZ3 HCR

Performance
Characteristic values for tension loads

Annex C1

Table C2: Characteristic values for tension loads under static or quasi-static action, BZ3 A4 and BZ3 HCR

Fastener size			BZ3 A4 and BZ3 HCR			
			M8	M10	M12	M16
Installation factor	γ_{inst}	[-]	1,0			
Steel failure						
Characteristic resistance	$N_{Rk,s}$	[kN]	19,8	30,4	44,9	74,6
Modulus of elasticity - BZ3 A4	E_s	[N/mm ²]	200.000			
Modulus of elasticity - BZ3 HCR	E_s	[N/mm ²]	195.000			
Partial factor	γ_{Ms}	[-]	1,5			
Pull-out						
Characteristic resistance in cracked concrete C20/25	$N_{Rk,p,cr}$	[kN]	9,5	17	22	35
Increasing factor for $N_{Rk,p,cr}$	ψ_C	[-]	$\left(\frac{f_{ck}}{20}\right)^{0,488}$	$\left(\frac{f_{ck}}{20}\right)^{0,5}$	$\left(\frac{f_{ck}}{20}\right)^{0,435}$	$\left(\frac{f_{ck}}{20}\right)^{0,350}$
Characteristic resistance in uncracked concrete C20/25	$N_{Rk,p,ucr}$	[kN]	20	25	42	50
Increasing factor for $N_{Rk,p,ucr}$	ψ_C	[-]	$\left(\frac{f_{ck}}{20}\right)^{0,240}$	$\left(\frac{f_{ck}}{20}\right)^{0,364}$	$\left(\frac{f_{ck}}{20}\right)^{0,213}$	$\left(\frac{f_{ck}}{20}\right)^{0,196}$
Splitting						
Characteristic resistance	$N^0_{Rk,sp}$	[kN]	$\min (N_{Rk,p} ; N^0_{Rk,c}{}^3)$			
Characteristic edge distance ²⁾	$c_{cr,sp}$	[mm]	$\frac{A_{sp} + 0,8 \cdot (h_{sp} - h_{ef})^2}{(3,41 \cdot h_{sp} - 0,59 \cdot h_{ef})}$			
Characteristic spacing	$s_{cr,sp}$	[mm]	$2 \cdot c_{cr,sp}$			
Concrete cone failure						
Minimum, effective anchorage depth	$h_{ef,min}$	[mm]	35 ¹⁾	40	50	65
Maximum, effective anchorage depth	$h_{ef,max}$	[mm]	90	100	125	160
Characteristic edge distance	$c_{cr,N}$	[mm]	$1,5 \cdot h_{ef}$			
Characteristic spacing	$s_{cr,N}$	[mm]	$2 \cdot c_{cr,N}$			
Factor k_1	cracked concrete	$k_{cr,N}$	7,7			
	uncracked concrete	$k_{ucr,N}$	11,0			

¹⁾ Fastenings with anchorage depth $h_{ef} < 40$ mm are restricted to the use of structural components which are statically indeterminate and subject to internal exposure conditions only

²⁾ Applicable concrete thickness h_{sp} and area A_{sp} according to Table B3 to determine characteristic edge distance $c_{cr,sp}$

³⁾ $N^0_{Rk,c}$ according to EN 1992-4:2018

Wedge Anchor BZ3 / BZ3 A4 / BZ3 HCR

Performance
Characteristic values for tension loads

Annex C2

Table C3: Characteristic values for shear loads under static and quasi-static action

Fastener size				BZ3 / BZ3 A4 / BZ3 HCR			
				M8	M10	M12	M16
Installation factor	γ_{inst}	[-]	1,0				
Steel failure <u>without</u> lever arm							
Characteristic resistance	BZ3	$V_{Rk,s}^0$ [kN]	15,7	26,8	38,3	60,0	
	BZ3 A4 / HCR	$V_{Rk,s}^0$ [kN]	16,8	27,8	39,8	69,5	
Partial factor	γ_{Ms}	[-]	1,25				
Ductility factor	k_7	[-]	1,0				
Steel failure <u>with</u> lever arm							
Characteristic bending resistance	BZ3	$M_{Rk,s}^0$ [Nm]	30	60	105	240	
	BZ3 A4 / HCR	$M_{Rk,s}^0$ [Nm]	27	55	99	223	
Partial factor	γ_{Ms}	[-]	1,25				
Concrete pry-out failure							
Pry-out factor	BZ3	k_8	[-]	2,8	3,1	3,0	3,6
	BZ3 A4 / HCR	k_8	[-]	2,7	2,8	3,3	3,4
Concrete edge failure							
Effective length of fastener in shear loading	l_f	[mm]	h_{ef} ¹⁾				
Outside diameter of fastener	d_{nom}	[mm]	8	10	12	16	

¹⁾ Fastenings with anchorage depth $h_{ef} < 40$ mm are restricted to the use of structural components which are statically indeterminate and subject to internal exposure conditions only.

Wedge Anchor BZ3 / BZ3 A4 / BZ3 HCR

Performance
Characteristic values for **shear loads**

Annex C3

Table C4: Characteristic values for seismic loading, performance category C1

Fastener size				BZ3 / BZ3 A4 / BZ3 HCR							
				M8		M10		M12		M16	
Effective anchorage depth	$h_{ef} \geq$	[mm]		40	45	40	60	50	70	65	85
Tension load											
Installation factor	γ_{inst}	[-]		1,0							
Steel failure											
Characteristic resistance	BZ3	$N_{Rk,s,C1}$	[kN]	19,8		30,4		44,9		79,3	
	BZ3 A4 / HCR	$N_{Rk,s,C1}$	[kN]	19,8		30,4		44,9		74,6	
Pull-out											
Characteristic resistance	BZ3	$N_{Rk,s,C1}$	[kN]	9,1		15,0		22,0		30,0	
	BZ3 A4 / HCR	$N_{Rk,s,C1}$	[kN]	9,0		17,0		22,0		35,0	
Shear load											
Steel failure without lever arm											
Characteristic resistance	BZ3	$V_{Rk,s,C1}$	[kN]	11,7	13,4	22,5	24,4	30,0	33,8	48,8	52,3
	BZ3 A4 / HCR	$V_{Rk,s,C1}$	[kN]	11,0	12,7	20,6	22,2	33,2	33,2	61,1	64,3
Factor for anchorages	with annular gap	α_{gap}	[-]	0,5							
	without annular gap	α_{gap}	[-]	1,0							

Table C5: Characteristic values for seismic loading, performance category C2

Fastener size				BZ3 / BZ3 A4 / BZ3 HCR							
				M8		M10		M12		M16	
Effective anchorage depth	$h_{ef} \geq$	[mm]		40	45	40	60	50	70	65	85
Tension load											
Installation factor	γ_{inst}	[-]		1,0							
Steel failure											
Characteristic resistance	BZ3	$N_{Rk,s,C2}$	[kN]	19,8		30,4		44,9		79,3	
	BZ3 A4 / HCR	$N_{Rk,s,C2}$	[kN]	19,8		30,4		44,9		74,6	
Pull-out											
Characteristic resistance	BZ3	$N_{Rk,s,C2}$	[kN]	2,8	3,6	7,3	12,5	10,7	19,0	19,8	35,2
	BZ3 A4 / HCR	$N_{Rk,s,C2}$	[kN]	2,3	3,2	5,0	7,7	8,0	13,8	19,0	29,4
Shear load											
Steel failure without lever arm											
Characteristic resistance	BZ3	$V_{Rk,s,C2}$	[kN]	7,3	11,3	15,4	19,0	18,3	28,0	39,4	43,3
	BZ3 A4 / HCR	$V_{Rk,s,C2}$	[kN]	7,5	8,6	12,5	15,9	22,4	25,6	42,7	46,1
Factor for anchorages	with annular gap	α_{gap}	[-]	0,5							
	without annular gap	α_{gap}	[-]	1,0							

Wedge Anchor BZ3 / BZ3 A4 / BZ3 HCR

Performance
Characteristic resistance for seismic loading

Annex C4

Table C6: Characteristic values for tension and shear load under fire exposure

Fastener size		BZ3 / BZ3 A4 / BZ3 HCR					
		M8	M10	M12	M16		
Tension load							
Steel failure							
Characteristic resistance	R30	$N_{Rk,s,fi}$	[kN]	1,2	2,6	4,6	7,7
	R60			1,0	1,9	3,3	5,6
	R90			0,7	1,3	2,1	3,5
	R120			0,6	1,0	1,5	2,5
Shear load							
Steel failure <u>without</u> lever arm							
Characteristic resistance	R30	$V_{Rk,s,fi}$	[kN]	4,0	7,5	12,3	20,7
	R60			2,7	5,1	8,5	14,2
	R90			1,4	2,7	4,6	7,7
	R120			0,8	1,6	2,7	4,5
Steel failure <u>with</u> lever arm							
Characteristic resistance	R30	$M^0_{Rk,s,fi}$	[Nm]	4,1	9,6	19,1	43,8
	R60			2,8	6,6	13,1	30,1
	R90			1,5	3,5	7,2	16,4
	R120			0,8	2,0	4,2	9,6

$N_{Rk,p,fi}$ according to EN 1992-4:2018

Wedge Anchor BZ3 / BZ3 A4 / BZ3 HCR

Performance
Characteristic values under fire exposure

Annex C5

Table C7: Displacements under tension load, BZ3 zinc plated

Fastener size			BZ3 (zp)							
			M8		M10		M12		M16	
Displacements under static or quasi-static action										
$\delta_{N0} = \delta_{N0-factor} \cdot N$			N: acting tension load							
$\delta_{N\infty} = \delta_{N\infty-factor} \cdot N$										
Effective anchorage depth	$h_{ef} \geq$	[mm]	35	40	50	65				
Cracked concrete										
Factor for displacement	$\delta_{N0-factor}$	[mm/kN]	0,13	0,05	0,04	0,03				
	$\delta_{N\infty-factor}$	[mm/kN]	0,29	0,20	0,15	0,11				
Uncracked concrete										
Factor for displacement	$\delta_{N0-factor}$	[mm/kN]	0,03	0,01	0,004	0,005				
	$\delta_{N\infty-factor}$	[mm/kN]	0,03	0,03	0,03	0,03				
Displacement under seismic action C2										
Effective anchorage depth	$h_{ef} \geq$	[mm]	40	45	40	60	50	70	65	85
Displacements for DLS	$\delta_{N, C2(DLS)}$	[mm]	3,9	4,9	2,8	4,7	2,4	4,2	2,5	4,5
Displacements for ULS	$\delta_{N, C2(ULS)}$	[mm]	11,3	14,3	9,4	16,1	7,3	12,9	7,2	12,8

Table C8: Displacements under tension load, BZ3 A4 and BZ3 HCR

Fastener size			BZ3 A4 / BZ3 HCR							
			M8		M10		M12		M16	
Displacements under static or quasi-static action										
$\delta_{N0} = \delta_{N0-factor} \cdot N$			N: acting tension load							
$\delta_{N\infty} = \delta_{N\infty-factor} \cdot N$										
Effective anchorage depth	$h_{ef} \geq$	[mm]	35	40	50	65				
Cracked concrete										
Factor for displacement	$\delta_{N0-factor}$	[mm/kN]	0,11	0,06	0,05	0,02				
	$\delta_{N\infty-factor}$	[mm/kN]	0,27	0,17	0,16	0,08				
Uncracked concrete										
Factor for displacement	$\delta_{N0-factor}$	[mm/kN]	0,02	0,00	0,001	0,00				
	$\delta_{N\infty-factor}$	[mm/kN]	0,05	0,05	0,05	0,05				
Displacement under seismic action C2										
Effective anchorage depth	$h_{ef} \geq$	[mm]	40	45	40	60	50	70	65	85
Displacements for DLS	$\delta_{N, C2(DLS)}$	[mm]	2,0	2,9	2,6	4,1	3,3	5,7	3,3	5,1
Displacements for ULS	$\delta_{N, C2(ULS)}$	[mm]	7,7	11,1	10,8	16,8	10,4	18,0	9,0	13,9

Wedge Anchor BZ3 / BZ3 A4 / BZ3 HCR

Performance
Displacements under tension load

Annex C6

Table C9: Displacements under shear load, BZ3 zinc plated

Fastener size			BZ3 (zp)							
			M8	M10	M12	M16				
Displacements under static or quasi-static action										
$\delta_{V0} = \delta_{V0-factor} \cdot V$			V: acting shear load							
$\delta_{V\infty} = \delta_{V\infty-factor} \cdot V$										
Effective anchorage depth	$h_{ef} \geq$	[mm]	35	40	50	65				
Factor for displacement	$\delta_{V0-factor}$	[mm/kN]	0,15	0,09	0,09	0,07				
	$\delta_{V\infty-factor}$	[mm/kN]	0,22	0,13	0,14	0,11				
Displacement under seismic action C2 ¹⁾										
Effective anchorage depth	$h_{ef} \geq$	[mm]	40	45	40	60	50	70	65	85
Displacements for DLS	$\delta_{V,C2(DLS)}$	[mm]	2,8	2,7	3,0	3,1	3,4	3,7	3,4	3,8
Displacements for ULS	$\delta_{V,C2(ULS)}$	[mm]	5,1	5,0	5,0	5,5	6,3	9,9	6,0	9,6

¹⁾ For anchorages with clearance in the fixture the annular gap must also be taken into account

Table C10: Displacements under shear load, BZ3 A4 and BZ3 HCR

Fastener size			BZ3 A4 / BZ3 HCR							
			M8	M10	M12	M16				
Displacements under static or quasi-static action										
$\delta_{V0} = \delta_{V0-factor} \cdot V$			V: acting shear load							
$\delta_{V\infty} = \delta_{V\infty-factor} \cdot V$										
Effective anchorage depth	$h_{ef} \geq$	[mm]	35	40	50	65				
Factor for displacement	$\delta_{V0-factor}$	[mm/kN]	0,26	0,14	0,12	0,09				
	$\delta_{V\infty-factor}$	[mm/kN]	0,39	0,20	0,17	0,14				
Displacement under seismic action C2 ¹⁾										
Effective anchorage depth	$h_{ef} \geq$	[mm]	40	45	40	60	50	70	65	85
Displacements for DLS	$\delta_{V,C2(DLS)}$	[mm]	2,8	3,0	3,4	3,5	3,5	4,2	3,8	4,4
Displacements for ULS	$\delta_{V,C2(ULS)}$	[mm]	5,2	5,1	7,0	8,4	7,5	11,8	7,8	11,1

¹⁾ For anchorages with clearance in the fixture the annular gap must also be taken into account

Wedge Anchor BZ3 / BZ3 A4 / BZ3 HCR

Performance
Displacements under shear load

Annex C7