



...eine starke Verbindung

IZJAVA O LASTNOSTIH

DoP Št.: MKT-1.1-901_sl

- ✧ **Enotna identifikacijska oznaka tipa proizvoda:** Wedge sidro BZ3 / BZ3 A4 / BZ3 HCR
- ✧ **Predvidena uporaba:** Mehanski mozniak za uporabo v betonu, glej Priloga/Annex B
- ✧ **Proizvajalec:** MKT Metall-Kunststoff-Technik GmbH & Co.KG
Auf dem Immel 2
67685 Weilerbach
- ✧ **Sistem ali sistemi ocenjevanja in preverjanja nespremenljivosti lastnosti:** 1
- ✧ **Evropski ocenjevalni dokument:** EAD 330232-01-0601
Evropska tehnična ocena: ETA-19/0619, 10.12.2021
Organ za tehnično ocenjevanje: DIBt, Berlin
Priglašeni organi: NB 2873 – Technische Universität Darmstadt

✧ **Navedene lastnosti:**

Bistvene značilnosti	Lastnosti
Mehanska odpornost in stabilnost (BWR 1)	
Najmanjša razdalja robov in središč	Priloga / Annex B3
Karakteristični upori pod natezno obremenitvijo (statični in kvazistatični učinki)	Priloga / Annex C1, C2
Karakteristični upori pod prečnim stresom (statični in kvazistatični učinki)	Priloga / Annex C3
Karakteristične upornosti za kategorije potresne učinkovitosti C1 + C2	Priloga / Annex C4
Premiki	Priloga / Annex C7, C8
Trajnost	Priloga / Annex B1
Varnost pri požaru (BWR 2)	
Ogenj vedenje	Razred A1
Požarna odpornost	Priloga / Annex C5, C6

Učinkovitost zgornjega izdelka je deklarirana zmogljivost / zmogljivost. Zgornji proizvajalec je izključno odgovoren za sestavo izjave o lastnostih v skladu z Uredbo (EU) št. 305/2011

Podpisal za in v imenu proizvajalca:

Stefan Weustenhagen
(Generalni direktor)
Weilerbach, 10.12.2021

p.p.

Dipl.-Ing. Detlef Bigalke
(Vodja razvoja izdelkov)



Izvirnik te izjave o uspešnosti je bil napisan v nemščini. Za odstopanja v prevodu velja nemška različica.

Specifications of intended use

Wedge Anchor	BZ3 / BZ3 A4 / BZ3 HCR			
	M8	M10	M12	M16
Static or quasi-static action	✓			
Seismic performance categories C1 and C2	✓			
Fire exposure	R30 / R60 / R90 / R120			
Variable, effective anchorage depth	35 mm to 90 mm	40 mm to 100 mm	50 mm to 125 mm	65 mm to 160 mm

Base materials:

- Cracked or uncracked concrete
- Reinforced or unreinforced normal weight concrete without fibres according to EN 206:2013 + A1:2016
- Strength classes C20/25 to C50/60 according to EN 206:2013 + A1:2016

Use conditions (Environmental conditions):

- Structures subject to dry internal conditions: all materials
- For all other conditions according to EN 1993-1-2006 + A1:2015-10, corresponding to corrosion resistance classes CRC according to Annex A3, Table A2

Design:

- Anchorages are designed under the responsibility of an engineer experienced in anchorages and concrete work.
- Verifiable calculation notes and drawings are prepared taking account of the loads to be anchored.
- The position of the fastener is indicated on the design drawings (e.g. position of the fastener relative to reinforcement or to supports, etc.).
- Design method EN 1992-4:2018 and Technical Report TR 055:2018

Installation:

- Hole drilling by hammer drill bit or vacuum drill bit
- Use of the fastener only as supplied by the manufacturer without exchanging the components of the fastener (exception: when using the cap nut HM)
- The anchor can be set in pre- or through-setting installation.
- Optionally, the annular gap between fixture and stud of BZ3 can be filled to reduce the hole clearance. For this purpose, the filling washer (Annex A3) must be used in addition to the supplied washer. For filling use MKT Injection Adhesive VMH, VMU plus, VMZ or other high-strength injection mortar with compressive strength $\geq 40\text{N/mm}^2$.

Wedge Anchor BZ3 / BZ3 A4 / BZ3 HCR	Annex B1
Intended use Specifications	

Table B1: Installation parameters

Anchor size			BZ3 / BZ3 A4 / BZ3 HCR				
			M8	M10	M12	M16	
Nominal drill hole diameter	d_0	[mm]	8	10	12	16	
Cutting diameter of drill bit	$d_{cut} \leq$	[mm]	8,45	10,45	12,5	16,5	
Minimum effective anchorage depth	$h_{ef,min}$	[mm]	35	40	50	65	
Maximum effective anchorage depth	$h_{ef,max}$	[mm]	90	100	125	160	
Depth of drill hole	$h_0 \geq$	[mm]	$h_{ef} + 8$	$h_{ef} + 9$	$h_{ef} + 10$	$h_{ef} + 14$	
	$h_1 \geq$	[mm]	$h_{ef} + 10$	$h_{ef} + 11$	$h_{ef} + 13$	$h_{ef} + 17$	
Diameter of clearance hole in the fixture ¹⁾	$d_f \leq$	[mm]	9	12	14	18	
Projection after anchor has been inserted for installing with cap nut HM (according to Annex B6, Figure 3)	C	[mm]	10,5	12,5	16,0	19,5	
Installation torque	BZ3	T_{inst}	[Nm]	15	40	60	110
	BZ3 A4 / HCR	T_{inst}	[Nm]	15	40	55	100

¹⁾ For larger diameters of clearance hole in the fixture, see EN 1992-4:2018, chapter 6.2.2.2

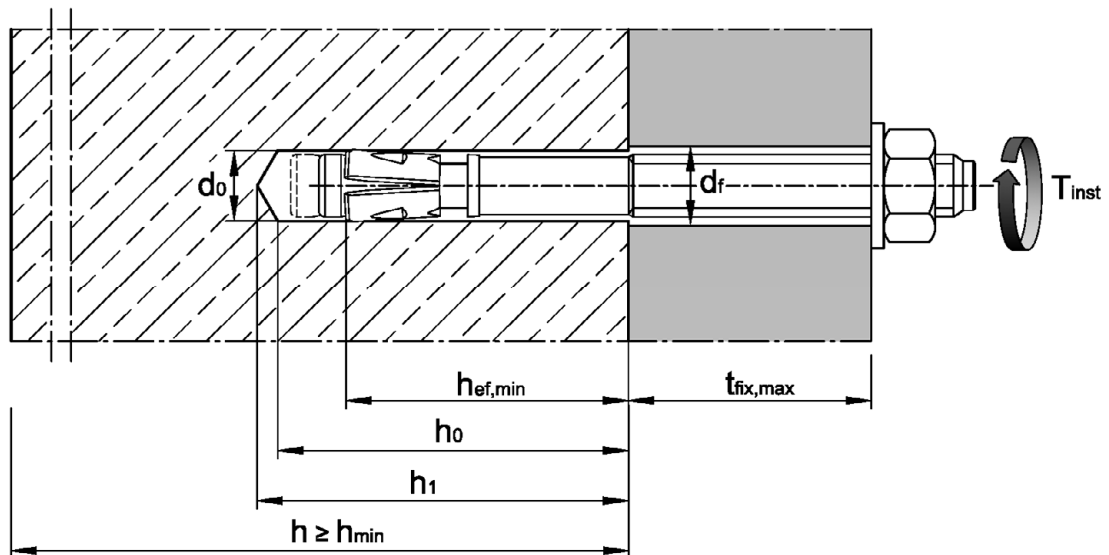

Wedge Anchor BZ3 / BZ3 A4 / BZ3 HCR

Intended use
Installation parameters

Annex B2

Table B2: Minimum thickness of concrete member, minimum spacings, edge distances

Anchor size			BZ3 / BZ3 A4 / BZ3 HCR			
			M8	M10	M12	M16
Minimum member thickness depending on h_{ef}	$h_{min} \geq$	[mm]	max (1,5 · h_{ef} ; 80)		max (1,5 · h_{ef} ; 100)	max (1,5 · h_{ef} ; 120)
Minimum edge distances and spacings						
Minimum edge distance	c_{min}	[mm]	40	45	55	65
	for $s \geq$	[mm]	see Table B4			
Minimum spacings	s_{min}	[mm]	35	40	50	65
	for $c \geq$	[mm]	see Table B4			
<p>The following equation must be fulfilled for the calculation of the minimum spacing and edge distance during installation in combination with variable anchorage depth and member thickness:</p> $A_{sp,req} \leq A_{sp,ef}$ <p>Required splitting area $A_{sp,req}$ and idealized splitting area $A_{sp,ef}$ according to Table B4.</p>						

Table B3: Applicable concrete thickness h_{sp} and area A_{sp} to determine characteristic edge distance $c_{cr,sp}$

Anchor size				M8	M10	M12	M16
Applicable concrete thickness	BZ3 BZ3 A4 BZ3 HCR	h_{sp}	[mm]	$\min(h ; h_{ef} + 1,5 \cdot c \cdot \sqrt{2})$			
Area to determine $c_{cr,sp}$ ¹⁾	BZ3	A_{sp}	[mm ²]	$\frac{N_{Rk,sp}^0 - 2,573}{0,000436}$	$\frac{N_{Rk,sp}^0 + 2,040}{0,000693}$	$\frac{N_{Rk,sp}^0 + 3,685}{0,000692}$	$\frac{N_{Rk,sp}^0 + 3,738}{0,000875}$
	BZ3 A4 BZ3 HCR	A_{sp}	[mm ²]	$\frac{N_{Rk,sp}^0 + 4,177}{0,000862}$	$\frac{N_{Rk,sp}^0 + 7,235}{0,000967}$	$\frac{N_{Rk,sp}^0 + 7,847}{0,000951}$	$\frac{N_{Rk,sp}^0 + 11,415}{0,000742}$

¹⁾ with $N_{Rk,sp}^0$ in kN

Wedge Anchor BZ3 / BZ3 A4 / BZ3 HCR	Annex B3
Intended use Minimum spacings and edge distances Required area and applicable concrete thickness	

Table B4: Areas to determine spacings and edge distances for installation

Anchor size	BZ3 / BZ3 A4 / BZ3 HCR						
	M8	M10	M12	M16			
<p>The following equation must be fulfilled for the calculation of the minimum spacing and edge distance during installation in combination with variable anchorage depth and member thickness:</p> $A_{sp,req} \leq A_{sp,ef}$							
<p>Idealized splitting area $A_{sp,ef}$ The edge distances and spacings shall be selected or rounded in steps of 5 mm.</p>							
<p>Member thickness: $h > h_{ef} + 1,5 \cdot c$</p>							
<p>Single anchor or anchor group with $s \geq 3 \cdot c$</p>							
Effective anchorage depth	$h_{ef} < 1,5 \cdot c$	$A_{sp,ef} = (6 \cdot c) \cdot (1,5 \cdot c + h_{ef})$		[mm ²]			
Effective anchorage depth	$h_{ef} \geq 1,5 \cdot c$	$A_{sp,ef} = (6 \cdot c) \cdot (3 \cdot c)$		[mm ²]			
<p>Anchor group ($s < 3 \cdot c$)</p>							
Effective anchorage depth	$h_{ef} < 1,5 \cdot c$	$A_{sp,ef} = (3 \cdot c + s) \cdot (1,5 \cdot c + h_{ef})$		[mm ²]			
Effective anchorage depth	$h_{ef} \geq 1,5 \cdot c$	$A_{sp,ef} = (3 \cdot c + s) \cdot (3 \cdot c)$		[mm ²]			
<p>Member thickness: $h \leq h_{ef} + 1,5 \cdot c$</p>							
<p>Single anchor or anchor group with $s \geq 3 \cdot c$</p>							
Effective anchorage depth	$h_{ef} < 1,5 \cdot c$	$A_{sp,ef} = (6 \cdot c) \cdot h$		[mm ²]			
Effective anchorage depth	$h_{ef} \geq 1,5 \cdot c$	$A_{sp,ef} = (6 \cdot c) \cdot (h - h_{ef} + 1,5 \cdot c)$		[mm ²]			
<p>Anchor group ($s < 3 \cdot c$)</p>							
Effective anchorage depth	$h_{ef} < 1,5 \cdot c$	$A_{sp,ef} = (3 \cdot c + s) \cdot h$		[mm ²]			
Effective anchorage depth	$h_{ef} \geq 1,5 \cdot c$	$A_{sp,ef} = (3 \cdot c + s) \cdot (h - h_{ef} + 1,5 \cdot c)$		[mm ²]			
<p>Required splitting area $A_{sp,req}$</p>							
BZ3	cracked concrete	$A_{sp,req}$	[mm ²]	13 900	23 700	31 500	42 300
	uncracked concrete	$A_{sp,req}$	[mm ²]	22 500	34 700	41 300	50 200
BZ3 A4	cracked concrete	$A_{sp,req}$	[mm ²]	16 900	25 900	29 800	44 300
BZ3 HCR	uncracked concrete	$A_{sp,req}$	[mm ²]	19 700	35 700	35 300	54 800

Wedge Anchor BZ3 / BZ3 A4 / BZ3 HCR

Intended use
 Projected effective area to determine spacings and edge distances

Annex B4

Installation instructions

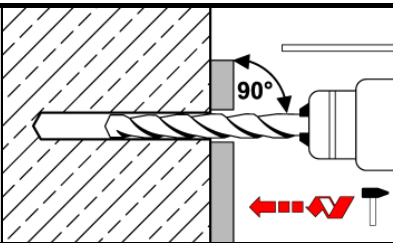
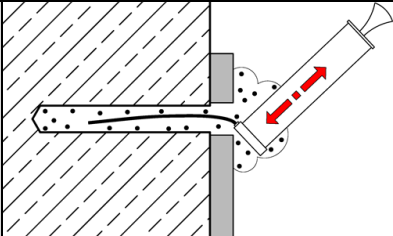
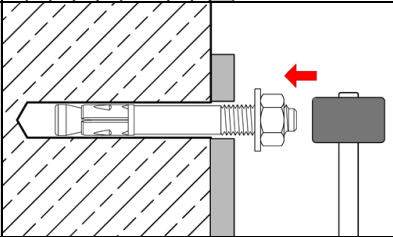
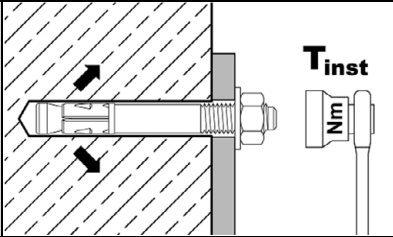
1		<p>Drill hole perpendicular to concrete surface. If using a vacuum drill bit, proceed with step 3.</p>
2		<p>Blow out dust. Alternatively vacuum clean down to the bottom of the hole.</p>
3		<p>Drive in fastener.</p>
4		<p>Apply installation torque T_{inst}.</p>

Wedge Anchor BZ3 / BZ3 A4 / BZ3 HCR

Intended use
Installation instructions

Annex B5

Installation with cap nut HM

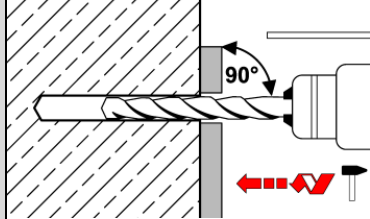
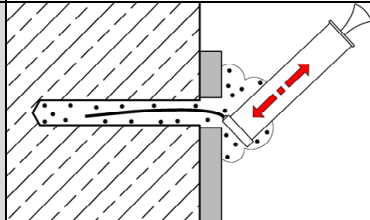
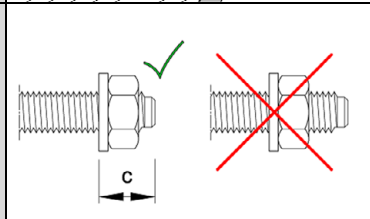
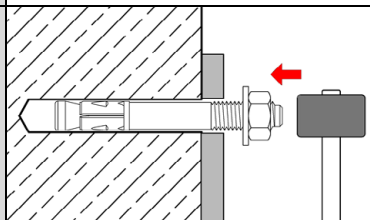
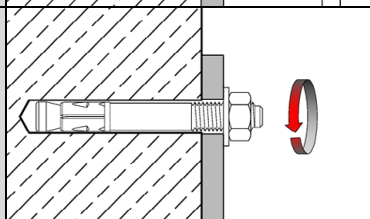
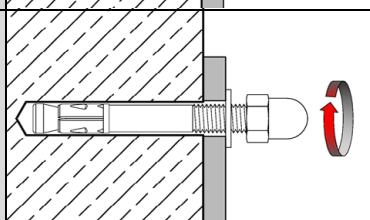
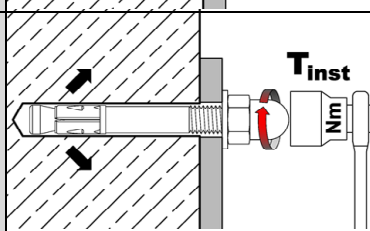
1		<p>Drill hole perpendicular to concrete surface. If using a vacuum drill bit, proceed with step 3.</p>
2		<p>Blow out dust. Alternatively vacuum clean down to the bottom of the hole.</p>
3		<p>Check position of nut. Projection C after anchor has been inserted see Annex B2, Table B1.</p>
4		<p>Drive in fastener.</p>
5		<p>Remove nut.</p>
6		<p>Screw on cap nut</p>
7		<p>Apply installation torque T_{inst}.</p>

Wedge Anchor BZ3 / BZ3 A4 / BZ3 HCR

Intended use
Installation instructions with cap nut

Annex B6

Installation instructions with filling of annular gap

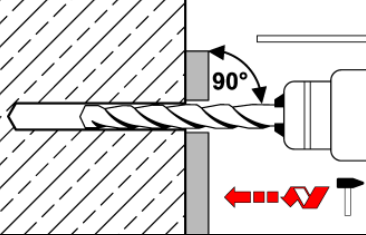
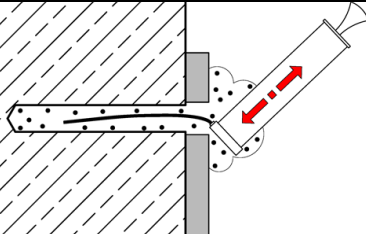
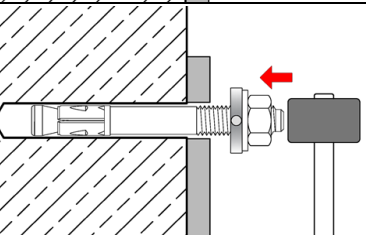
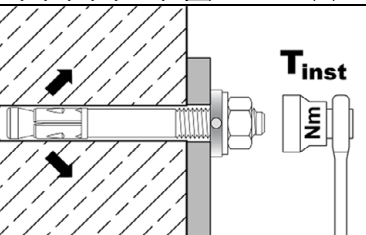
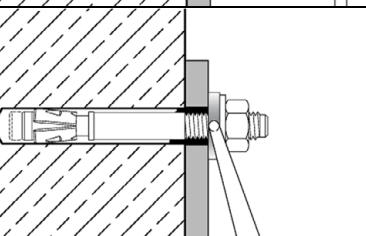
1		<p>Drill hole perpendicular to concrete surface. If using a vacuum drill bit, proceed with step 3.</p>
2		<p>Blow out dust. Alternatively vacuum clean down to the bottom of the hole.</p>
3		<p>Drive in fastener with additionally mounted filling washer.</p>
4		<p>Apply installation torque T_{inst}.</p>
5		<p>Fill the annular gap between anchor and fixture with injection adhesive (see Annex B1). Use enclosed reducing adapter. The annular gap is completely filled, when excess mortar seeps out.</p>

Wedge Anchor BZ3 / BZ3 A4 / BZ3 HCR

Intended use
Installation instructions with filling of annular gap

Annex B7

Table C1: Characteristic values for tension loads under static and quasi-static action, **BZ3** (steel, zinc plated)

Fastener size			BZ3			
			M8	M10	M12	M16
Installation factor	γ_{inst}	[-]	1,0			
Steel failure						
Characteristic resistance	$N_{Rk,s}$	[kN]	19,8	30,4	44,9	79,3
Partial factor ⁴⁾	γ_{Ms}	[-]	1,5			
Pull-out						
Characteristic resistance in cracked concrete C20/25	$N_{Rk,p,cr}$	[kN]	9,5	15	22	30
Increasing factor $N_{Rk,p,cr} = \psi_C \cdot N_{Rk,p,cr} (C20/25)$	ψ_C	[-]	$\left(\frac{f_{ck}}{20}\right)^{0,439}$	$\left(\frac{f_{ck}}{20}\right)^{0,265}$	$\left(\frac{f_{ck}}{20}\right)^{0,5}$	$\left(\frac{f_{ck}}{20}\right)^{0,339}$
Characteristic resistance in uncracked concrete C20/25	$N_{Rk,p,ucr}$	[kN]	14	24	30	50
Increasing factor $N_{Rk,p,ucr} = \psi_C \cdot N_{Rk,p,ucr} (C20/25)$	ψ_C	[-]	$\left(\frac{f_{ck}}{20}\right)^{0,489}$	$\left(\frac{f_{ck}}{20}\right)^{0,448}$	$\left(\frac{f_{ck}}{20}\right)^{0,5}$	$\left(\frac{f_{ck}}{20}\right)^{0,203}$
Splitting						
Characteristic resistance	$N^0_{Rk,sp}$	[kN]	$\min (N_{Rk,p} ; N^0_{Rk,c})^3$			
Characteristic edge distance ²⁾	$C_{cr,sp}$	[mm]	$\frac{A_{sp} + 0,8 \cdot (h_{sp} - h_{ef})^2}{(3,41 \cdot h_{sp} - 0,59 \cdot h_{ef})}$			
Characteristic spacing	$S_{cr,sp}$	[mm]	$2 \cdot C_{cr,sp}$			
Concrete cone failure						
Minimum, effective anchorage depth	$h_{ef,min}$	[mm]	35 ¹⁾	40	50	65
Maximum, effective anchorage depth	$h_{ef,max}$	[mm]	90	100	125	160
Characteristic edge distance	$C_{cr,N}$	[mm]	$1,5 \cdot h_{ef}$			
Characteristic spacing	$S_{cr,N}$	[mm]	$2 \cdot C_{cr,N}$			
Factor	cracked concrete	$k_{cr,N}$	7,7			
	uncracked concrete	$k_{ucr,N}$	11,0			

¹⁾ Fastenings with anchorage depth $h_{ef} < 40$ mm are restricted to the use of structural components which are statically indeterminate and subject to internal exposure conditions only.

²⁾ Applicable concrete thickness h_{sp} and area A_{sp} to determine characteristic edge distance $C_{cr,sp}$ according to Table B3

³⁾ $N^0_{Rk,c}$ according to EN 1992-4:2018

⁴⁾ In absence of other national regulations

Wedge Anchor BZ3 / BZ3 A4 / BZ3 HCR

Annex C1

Performance

Characteristic values for **tension loads, BZ3** (Steel, zinc plated)

Table C2: Characteristic values for **tension loads** under static or quasi-static action, **BZ3 A4** and **BZ3 HCR**

Fastener size			BZ3 A4 / BZ3 HCR			
			M8	M10	M12	M16
Installation factor	γ_{inst}	[-]	1,0			
Steel failure						
Characteristic resistance	$N_{Rk,s}$	[kN]	19,8	30,4	44,9	74,6
Partial factor ⁴⁾	γ_{Ms}	[-]	1,5			
Pull-out						
Characteristic resistance in cracked concrete C20/25	$N_{Rk,p,cr}$	[kN]	9,5	17	22	35
Increasing factor $N_{Rk,p,cr} = \psi_C \cdot N_{Rk,p,cr} (C20/25)$	ψ_C	[-]	$\left(\frac{f_{ck}}{20}\right)^{0,488}$	$\left(\frac{f_{ck}}{20}\right)^{0,5}$	$\left(\frac{f_{ck}}{20}\right)^{0,435}$	$\left(\frac{f_{ck}}{20}\right)^{0,350}$
Characteristic resistance in uncracked concrete C20/25	$N_{Rk,p,ucr}$	[kN]	20	25	42	50
Increasing factor $N_{Rk,p,ucr} = \psi_C \cdot N_{Rk,p,ucr} (C20/25)$	ψ_C	[-]	$\left(\frac{f_{ck}}{20}\right)^{0,240}$	$\left(\frac{f_{ck}}{20}\right)^{0,364}$	$\left(\frac{f_{ck}}{20}\right)^{0,213}$	$\left(\frac{f_{ck}}{20}\right)^{0,196}$
Splitting						
Characteristic resistance	$N^0_{Rk,sp}$	[kN]	$\min (N_{Rk,p} ; N^0_{Rk,c}{}^3)$			
Characteristic edge distance ²⁾	$C_{cr,sp}$	[mm]	$\frac{A_{sp} + 0,8 \cdot (h_{sp} - h_{ef})^2}{(3,41 \cdot h_{sp} - 0,59 \cdot h_{ef})}$			
Characteristic spacing	$S_{cr,sp}$	[mm]	$2 \cdot C_{cr,sp}$			
Concrete cone failure						
Minimum, effective anchorage depth	$h_{ef,min}$	[mm]	35 ¹⁾	40	50	65
Maximum, effective anchorage depth	$h_{ef,max}$	[mm]	90	100	125	160
Characteristic edge distance	$C_{cr,N}$	[mm]	$1,5 \cdot h_{ef}$			
Characteristic spacing	$S_{cr,N}$	[mm]	$2 \cdot C_{cr,N}$			
Factor	cracked concrete	$k_{cr,N}$	7,7			
	uncracked concrete	$k_{ucr,N}$	11,0			

1) Fastenings with anchorage depth $h_{ef} < 40$ mm are restricted to the use of structural components which are statically indeterminate and subject to internal exposure conditions only

2) Applicable concrete thickness h_{sp} and area A_{sp} according to Table B3 to determine characteristic edge distance $C_{cr,sp}$

3) $N^0_{Rk,c}$ according to EN 1992-4:2018

4) In absence of other national regulations

Wedge Anchor BZ3 / BZ3 A4 / BZ3 HCR

Performance
Characteristic values for **tension loads, BZ3 A4** and **BZ3 HCR**

Annex C2

Table C3: Characteristic values for **shear loads** under static and quasi-static action

Fastener size				BZ3 / BZ3 A4 / BZ3 HCR			
				M8	M10	M12	M16
Installation factor		γ_{inst}	[-]	1,0			
Steel failure <u>without</u> lever arm							
Characteristic resistance	BZ3	$V_{RK,s}^0$	[kN]	15,7	26,8	38,3	60,0
	BZ3 A4 / HCR	$V_{RK,s}^0$	[kN]	16,8	27,8	39,8	69,5
Partial factor ²⁾		γ_{Ms}	[-]	1,25			
Ductility factor		k_7	[-]	1,0			
Steel failure <u>with</u> lever arm							
Characteristic bending resistance	BZ3	$M_{RK,s}^0$	[Nm]	30	60	105	240
	BZ3 A4 / HCR	$M_{RK,s}^0$	[Nm]	27	55	99	223
Partial factor ²⁾		γ_{Ms}	[-]	1,25			
Concrete pry-out failure							
Pry-out factor	BZ3	k_8	[-]	2,8	3,1	3,0	3,6
	BZ3 A4 / HCR	k_8	[-]	2,7	2,8	3,3	3,4
Concrete edge failure							
Effective length of fastener in shear loading		l_f	[mm]	$h_{ef}^{1)}$			
Outside diameter of fastener		d_{nom}	[mm]	8	10	12	16

¹⁾ Fastenings with anchorage depth $h_{ef} < 40$ mm are restricted to the use of structural components which are statically indeterminate and subject to internal exposure conditions only.

²⁾ In absence of other national regulations

Wedge Anchor BZ3 / BZ3 A4 / BZ3 HCR

Performance
Characteristic values for **shear loads**

Annex C3

Table C4: Characteristic values for seismic loading, performance category C1

Fastener size				BZ3 / BZ3 A4 / BZ3 HCR							
				M8		M10		M12		M16	
Effective anchorage depth	$h_{ef} \geq$	[mm]		40	45	40	60	50	70	65	85
Tension load											
Installation factor	γ_{inst}	[-]		1,0							
Steel failure											
Characteristic resistance	BZ3	$N_{Rk,s,C1}$	[kN]	19,8		30,4		44,9		79,3	
	BZ3 A4 / HCR	$N_{Rk,s,C1}$	[kN]	19,8		30,4		44,9		74,6	
Pull-out											
Characteristic resistance	BZ3	$N_{Rk,p,C1}$	[kN]	9,1		15,0		22,0		30,0	
	BZ3 A4 / HCR	$N_{Rk,p,C1}$	[kN]	9,0		17,0		22,0		35,0	
Shear load											
Steel failure without lever arm											
Characteristic resistance	BZ3	$V_{Rk,s,C1}$	[kN]	11,7	13,4	22,5	24,4	30,0	33,8	48,8	52,3
	BZ3 A4 / HCR	$V_{Rk,s,C1}$	[kN]	11,0	12,7	20,6	22,2	33,2	33,2	61,1	64,3
Factor for anchorages	with annular gap	α_{gap}	[-]	0,5							
	without annular gap	α_{gap}	[-]	1,0							

Table C5: Characteristic values for seismic loading, performance category C2

Fastener size				BZ3 / BZ3 A4 / BZ3 HCR							
				M8		M10		M12		M16	
Effective anchorage depth	$h_{ef} \geq$	[mm]		40	45	40	60	50	70	65	85
Tension load											
Installation factor	γ_{inst}	[-]		1,0							
Steel failure											
Characteristic resistance	BZ3	$N_{Rk,s,C2}$	[kN]	19,8		30,4		44,9		79,3	
	BZ3 A4 / HCR	$N_{Rk,s,C2}$	[kN]	19,8		30,4		44,9		74,6	
Pull-out											
Characteristic resistance	BZ3	$N_{Rk,p,C2}$	[kN]	2,8	3,6	7,3	12,5	10,7	19,0	19,8	35,2
	BZ3 A4 / HCR	$N_{Rk,p,C2}$	[kN]	2,3	3,2	5,0	7,7	8,0	13,8	19,0	29,4
Shear load											
Steel failure without lever arm											
Characteristic resistance	BZ3	$V_{Rk,s,C2}$	[kN]	7,3	11,3	15,4	19,0	18,3	28,0	39,4	43,3
	BZ3 A4 / HCR	$V_{Rk,s,C2}$	[kN]	7,5	8,6	12,5	15,9	22,4	25,6	42,7	46,1
Factor for anchorages	with annular gap	α_{gap}	[-]	0,5							
	without annular gap	α_{gap}	[-]	1,0							

Wedge Anchor BZ3 / BZ3 A4 / BZ3 HCR

Performance
Characteristic resistance for **seismic loading**

Annex C4

Table C6: Characteristic values for tension and shear load under fire exposure, BZ3 (steel, zinc plated)

Fastener size				BZ3			
				M8	M10	M12	M16
Tension load							
Steel failure							
Characteristic resistance	R30	$N_{Rk,s,fi}$	[kN]	1,2	2,6	4,6	7,7
	R60			1,0	1,9	3,3	5,6
	R90			0,7	1,3	2,1	3,5
	R120			0,6	1,0	1,5	2,5
Shear load							
Steel failure <u>without</u> lever arm							
Characteristic resistance	R30	$V_{Rk,s,fi}$	[kN]	4,0	7,5	12,3	20,7
	R60			2,7	5,1	8,5	14,2
	R90			1,4	2,7	4,6	7,7
	R120			0,8	1,6	2,7	4,5
Steel failure <u>with</u> lever arm							
Characteristic resistance	R30	$M^0_{Rk,s,fi}$	[Nm]	4,1	9,6	19,1	43,8
	R60			2,8	6,6	13,1	30,1
	R90			1,5	3,5	7,2	16,4
	R120			0,8	2,0	4,2	9,6

$N_{Rk,p,fi}$ and $N_{Rk,c,fi}$ according to EN 1992-4:2018

Wedge Anchor BZ3 / BZ3 A4 / BZ3 HCR

Performance
 Characteristic values under **fire exposure, BZ3** (steel, zinc plated)

Annex C5

Table C7: Characteristic values for tension and shear load under fire exposure, BZ3 A4 and BZ3 HCR

Fastener size				BZ3 A4 / BZ3 HCR			
				M8	M10	M12	M16
Tension load							
Steel failure							
Characteristic resistance	R30	$N_{Rk,s,fi}$	[kN]	4,0	6,9	11,0	18,1
	R60			2,9	5,0	8,0	13,1
	R90			1,8	3,1	4,9	8,1
	R120			1,2	2,1	3,4	5,6
Shear load							
Steel failure <u>without</u> lever arm							
Characteristic resistance	R30	$V_{Rk,s,fi}$	[kN]	8,5	17,6	32,0	52,6
	R60			6,2	12,6	22,6	37,1
	R90			3,9	7,5	13,1	21,5
	R120			2,8	5,0	8,4	13,8
Steel failure <u>with</u> lever arm							
Characteristic resistance	R30	$M^0_{Rk,s,fi}$	[Nm]	8,7	22,7	49,8	111,5
	R60			6,3	16,2	35,1	78,6
	R90			4,0	9,7	20,4	45,6
	R120			2,8	6,5	13,0	29,2

$N_{Rk,p,fi}$ and $N_{Rk,c,fi}$ according to EN 1992-4:2018

Wedge Anchor BZ3 / BZ3 A4 / BZ3 HCR	Annex C6
Performance Characteristic values under fire exposure, BZ3 A4 and BZ3 HCR	

Table C8: Displacements under tension load, BZ3 (steel, zinc plated)

Fastener size			BZ3							
			M8		M10		M12		M16	
Displacements under static or quasi-static action										
$\delta_{N0} = \delta_{N0\text{-factor}} \cdot N$			N: acting tension load							
$\delta_{N\infty} = \delta_{N\infty\text{-factor}} \cdot N$										
Effective anchorage depth	$h_{ef} \geq$	[mm]	35		40		50		65	
Cracked concrete										
Factor for displacement	$\delta_{N0\text{-factor}}$	[mm/kN]	0,13		0,05		0,04		0,03	
	$\delta_{N\infty\text{-factor}}$	[mm/kN]	0,29		0,20		0,15		0,11	
Uncracked concrete										
Factor for displacement	$\delta_{N0\text{-factor}}$	[mm/kN]	0,03		0,01		0,004		0,005	
	$\delta_{N\infty\text{-factor}}$	[mm/kN]	0,03		0,03		0,03		0,03	
Displacement under seismic action C2										
Effective anchorage depth	$h_{ef} \geq$	[mm]	40	45	40	60	50	70	65	85
Displacements for DLS	$\delta_{N, C2(DLS)}$	[mm]	3,9	4,9	2,8	4,7	2,4	4,2	2,5	4,5
Displacements for ULS	$\delta_{N, C2(ULS)}$	[mm]	11,3	14,3	9,4	16,1	7,3	12,9	7,2	12,8

Table C9: Displacements under tension load, BZ3 A4 and BZ3 HCR

Fastener size			BZ3 A4 / BZ3 HCR							
			M8		M10		M12		M16	
Displacements under static or quasi-static action										
$\delta_{N0} = \delta_{N0\text{-factor}} \cdot N$			N: acting tension load							
$\delta_{N\infty} = \delta_{N\infty\text{-factor}} \cdot N$										
Effective anchorage depth	$h_{ef} \geq$	[mm]	35		40		50		65	
Cracked concrete										
Factor for displacement	$\delta_{N0\text{-factor}}$	[mm/kN]	0,11		0,06		0,05		0,02	
	$\delta_{N\infty\text{-factor}}$	[mm/kN]	0,27		0,17		0,16		0,08	
Uncracked concrete										
Factor for displacement	$\delta_{N0\text{-factor}}$	[mm/kN]	0,02		0,00		0,001		0,00	
	$\delta_{N\infty\text{-factor}}$	[mm/kN]	0,05		0,05		0,05		0,05	
Displacement under seismic action C2										
Effective anchorage depth	$h_{ef} \geq$	[mm]	40	45	40	60	50	70	65	85
Displacements for DLS	$\delta_{N, C2(DLS)}$	[mm]	2,0	2,9	2,6	4,1	3,3	5,7	3,3	5,1
Displacements for ULS	$\delta_{N, C2(ULS)}$	[mm]	7,7	11,1	10,8	16,8	10,4	18,0	9,0	13,9

Wedge Anchor BZ3 / BZ3 A4 / BZ3 HCR

Performance
Displacements under tension load

Annex C7

Table C10: Displacements under shear load, BZ3 (steel, zinc plated)

Fastener size			BZ3							
			M8	M10	M12	M16				
Displacements under static or quasi-static action										
$\delta_{V0} = \delta_{V0\text{-factor}} \cdot V$			V: acting shear load							
$\delta_{V\infty} = \delta_{V\infty\text{-factor}} \cdot V$										
Effective anchorage depth	$h_{ef} \geq$	[mm]	35	40	50	65				
Factor for displacement	$\delta_{V0\text{-factor}}$	[mm/kN]	0,15	0,09	0,09	0,07				
	$\delta_{V\infty\text{-factor}}$	[mm/kN]	0,22	0,13	0,14	0,11				
Displacement under seismic action C2 ¹⁾										
Effective anchorage depth	$h_{ef} \geq$	[mm]	40	45	40	60	50	70	65	85
Displacements for DLS	$\delta_{V,C2(DLS)}$	[mm]	2,8	2,7	3,0	3,1	3,4	3,7	3,4	3,8
Displacements for ULS	$\delta_{V,C2(ULS)}$	[mm]	5,1	5,0	5,0	5,5	6,3	9,9	6,0	9,6

¹⁾ For anchorages with clearance in the fixture the annular gap must also be taken into account.

Table C11: Displacements under shear load, BZ3 A4 and BZ3 HCR

Fastener size			BZ3 A4 / BZ3 HCR							
			M8	M10	M12	M16				
Displacements under static or quasi-static action										
$\delta_{V0} = \delta_{V0\text{-factor}} \cdot V$			V: acting shear load							
$\delta_{V\infty} = \delta_{V\infty\text{-factor}} \cdot V$										
Effective anchorage depth	$h_{ef} \geq$	[mm]	35	40	50	65				
Factor for displacement	$\delta_{V0\text{-factor}}$	[mm/kN]	0,26	0,14	0,12	0,09				
	$\delta_{V\infty\text{-factor}}$	[mm/kN]	0,39	0,20	0,17	0,14				
Displacement under seismic action C2 ¹⁾										
Effective anchorage depth	$h_{ef} \geq$	[mm]	40	45	40	60	50	70	65	85
Displacements for DLS	$\delta_{V,C2(DLS)}$	[mm]	2,8	3,0	3,4	3,5	3,5	4,2	3,8	4,4
Displacements for ULS	$\delta_{V,C2(ULS)}$	[mm]	5,2	5,1	7,0	8,4	7,5	11,8	7,8	11,1

¹⁾ For anchorages with clearance in the fixture the annular gap must also be taken into account

Wedge Anchor BZ3 / BZ3 A4 / BZ3 HCR	Annex C8
Performance Displacements under tension load	