

## DICHIARAZIONE DI PRESTAZIONE

DoP N. MKT-1.4-100\_it

- ✧ **Codice di identificazione unico del prodotto-tipo:** **Ancoraggio a cuneo BZ3 dynamic**
- ✧ **Usi previsti:** Meccanico anchor per l'ancoraggio nel calcestruzzo, vedi allegato B /Annex B
- ✧ **Fabbricante:** MKT Metall-Kunststoff-Technik GmbH & Co.KG  
Auf dem Immel 2  
67685 Weilerbach
- ✧ **Sistemi di VVCP:** 1
- ✧ **Documento per la valutazione europea:** **EAD 330250-00-0601**  
Valutazione tecnica europea: **ETA-20/0117, 19.06.2020**  
Organismo di valutazione tecnica: **DIBt, Berlin**  
Organismi notificati: **NB 2873 – Technische Universität Darmstadt**

✧ **Prestazioni dichiarate:**

Caratteristiche essenziali (Metodo di valutazione B)	Prestazione
<b>Resistenza meccanica e stabilità (BWR 1)</b>	
Resistenza alla fatica caratteristica sotto sforzo di trazione ciclico	Allegato / Annex C1
Resistenza alla fatica caratteristica sotto carichi trasversali ciclici	
Resistenza alla fatica caratteristica in combinazione ciclica carichi di trazione e trasversali	
Carico fattore di trasferimento per ciclico carichi di trazione e trasversali	

La prestazione del prodotto sopra identificato è conforme all'insieme delle prestazioni dichiarate. La presente dichiarazione di responsabilità viene emessa, in conformità al regolamento (UE) n. 305/2011, sotto la sola responsabilità del fabbricante sopra identificato.

Firmato a nome e per conto del fabbricante da:



**Stefan Weustenhagen**  
(Direttore Generale)  
Weilerbach, 01.01.2021

p.p.



**Dipl.-Ing. Detlef Bigalke**  
(Direttore del Sviluppo del Prodotto)



L'originale di questa dichiarazione di prestazione è stata scritta in tedesco. In caso di deviazioni nella traduzione, la versione tedesca è valida.

## Specifications of intended use

### Anchorage subject to:

- Fatigue cyclic loading
- Static and quasi-static action, fire exposure and seismic performance according to ETA-19/0619

### Base materials:

- Cracked or uncracked concrete
- Compacted, reinforced or unreinforced normal weight concrete without fibres according to EN 206: 2013+A1:2016
- Strength classes C20/25 to C50/60 according to EN 206:2013+A1:2016

### Use conditions (Environmental conditions):

- Structures subject to dry internal conditions

### Design:

- Anchorages are designed under the responsibility of an engineer experienced in anchorages and concrete work.
- Verifiable calculation notes and drawings are prepared taking account of the loads to be anchored. The position of the fastener is indicated on the design drawings (e.g. position of the fastener relative to reinforcement or to supports, etc.).
- Design method EN 1992-4:2018 and TR 061 (design method II)

### Installation:

- Hole drilling by hammer drill bit or vacuum drill bit
- Use of the fastener only as supplied by the manufacturer without exchanging the components of the fastener

**Wedge Anchor BZ3 dynamic**

**Intended use**  
Specifications of intended use

**Annex B1**

**Table B1: Installation parameters**

Anchor size		M10	M12	M16
Nominal drill hole diameter	$d_0 =$ [mm]	10	12	16
Cutting diameter of drill bit	$d_{cut} \leq$ [mm]	10,45	12,5	16,5
Effective anchorage depth <sup>1)</sup>	$h_{ef} \geq$ [mm]	60	70	85
Depth of drill hole	$h_0 \geq$ [mm]	$h_{ef} + 9$	$h_{ef} + 10$	$h_{ef} + 14$
	$h_1 \geq$ [mm]	$h_{ef} + 11$	$h_{ef} + 13$	$h_{ef} + 17$
Diameter of clearance hole in the fixture	$d_f =$ [mm]	12	14	18
Minimum fixture thickness	$t_{fix, min} =$ [mm]	5	6	8
Installation torque	$T_{inst} =$ [Nm]	40	60	110
Overstand	$h_p \leq$ [mm]	$21,5 + t_{fix}$	$25,5 + t_{fix}$	$29,5 + t_{fix}$
Length of fastener	L [mm]	$h_{ef} + t_{fix} + 30,5$	$h_{ef} + t_{fix} + 35,5$	$h_{ef} + t_{fix} + 43$
Hexagon nut	width across nut SW [mm]	17	19	24
Locknut	width across nut SW [mm]	17	19	24

<sup>1)</sup> End of thread must be above the concrete surface

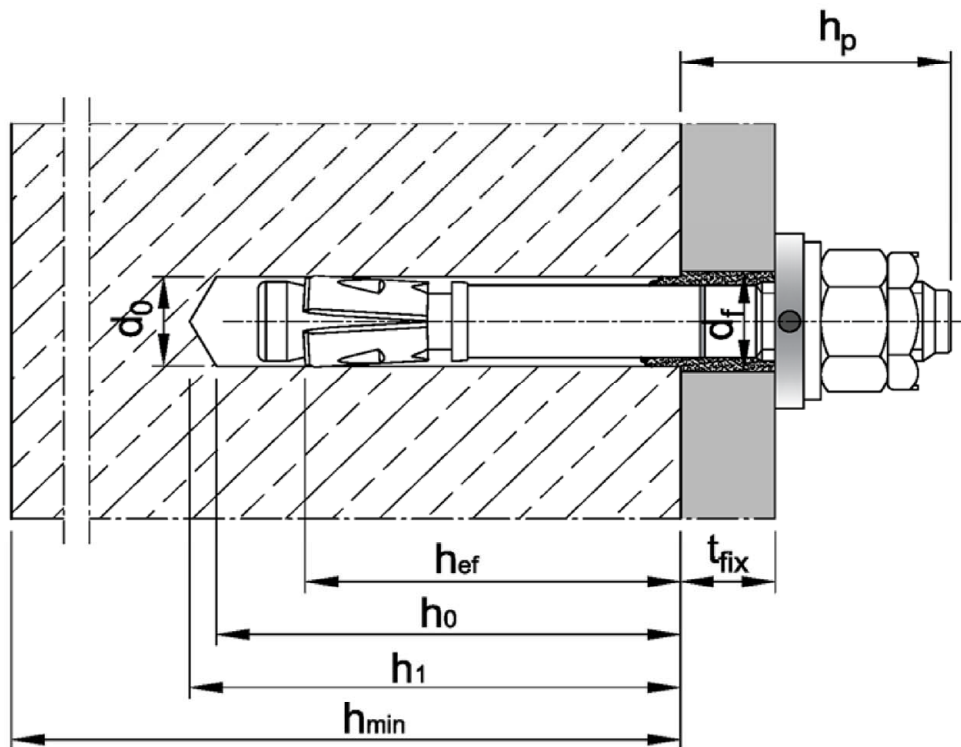

**Wedge Anchor BZ3 dynamic**

**Intended use**  
Installation parameters

**Annex B2**

**Table B2: Minimum thickness of concrete member, minimum spacings, edge distances and required area**

Anchor size			M10	M12	M16	
Minimum member thickness depending on $h_{ef}$	$h_{min} \geq$	[mm]	1,5 · $h_{ef}$			
<b>Minimum edge distances and spacings</b>						
Minimum edge distance	$c_{min}$	[mm]	45	55	65	
Minimum spacings	$s_{min}$	[mm]	40	50	65	
<b>Projected required area <math>A_{pr,req}</math></b>						
Projected required area	cracked concrete	$A_{pr,req}$	[mm <sup>2</sup> ]	23 700	31 500	42 300
	uncracked concrete	$A_{pr,req}$	[mm <sup>2</sup> ]	34 700	41 300	50 200
<b>The edge distances and spacings shall be selected in steps of 5 mm. In combination with variable anchorage depths and member thicknesses, the following equation must be fulfilled:</b>						
$A_{pr,req} \leq A_{pr,ef}$			$A_{pr,req}$	Projected required area		
			$A_{pr,ef}$	Projected effective area (acc. to Table B4)		

**Table B3: Applicable concrete thickness  $h_{sp}$  and area  $A_{sp}$  to determine characteristic edge distance  $c_{cr,sp}$**

Anchor size			M10	M12	M16
Applicable concrete thickness	$h_{sp}$	[mm]	$\min(h; h_{ef} + 1,5 \cdot c \cdot \sqrt{2})$		
Area to determine $c_{cr,sp}$ <sup>1)</sup>	$A_{sp}$	[mm <sup>2</sup> ]	$\frac{N_{Rk,sp}^0 + 2,040}{0,000693}$	$\frac{N_{Rk,sp}^0 + 3,685}{0,000692}$	$\frac{N_{Rk,sp}^0 + 3,738}{0,000875}$

<sup>1)</sup> with  $N_{Rk,sp}^0$  in kN according to ETA-19/0619

<b>Wedge Anchor BZ3 dynamic</b>	<b>Annex B3</b>
<b>Intended use</b> Minimum spacings and edge distances Required area and applicable concrete thickness	

**Table B4: Projected effective area  $A_{pr,ef}$  to determine spacings and edge distances**

Member thickness: $h > h_{ef} + 1,5 \cdot c$			
Effective anchorage depth $h_{ef} < 1,5 \cdot c$		Effective anchorage depth $h_{ef} \geq 1,5 \cdot c$	
Anchor group with $s \geq 3 \cdot c$ or single anchor			
$A_{pr,ef} = 2 \cdot (3 \cdot c) \cdot (1,5 \cdot c + h_{ef})$ [mm <sup>2</sup> ]		$A_{pr,ef} = 2 \cdot (3 \cdot c) \cdot (3 \cdot c)$ [mm <sup>2</sup> ]	
Anchor group ( $s < 3 \cdot c$ )			
$A_{pr,ef} = (3 \cdot c + s) \cdot (1,5 \cdot c + h_{ef})$ [mm <sup>2</sup> ]		$A_{pr,ef} = (3 \cdot c + s) \cdot (3 \cdot c)$ [mm <sup>2</sup> ]	
Member thickness: $h \leq h_{ef} + 1,5 \cdot c$			
Effective anchorage depth $h_{ef} \leq 1,5 \cdot c$		Effective anchorage depth $h_{ef} > 1,5 \cdot c$	
Anchor group with $s \geq 3 \cdot c$ or single anchor			
$A_{pr,ef} = 2 \cdot (3 \cdot c) \cdot h$ [mm <sup>2</sup> ]		$A_{pr,ef} = 2 \cdot (3 \cdot c) \cdot (h - h_{ef} + 1,5 \cdot c)$ [mm <sup>2</sup> ]	
Anchor group ( $s < 3 \cdot c$ )			
$A_{pr,ef} = (3 \cdot c + s) \cdot h$ [mm <sup>2</sup> ]		$A_{pr,ef} = (3 \cdot c + s) \cdot (h - h_{ef} + 1,5 \cdot c)$ [mm <sup>2</sup> ]	
<p>If the area <math>A_{pr,ef}</math> is trimmed by lateral edges (<math>c_2 &lt; 1,5 \cdot c</math>), calculate the area actually present. The spacings and edge distances shall be rounded to 5 mm.</p>			

**Wedge Anchor BZ3 dynamic**

**Intended use**  
Projected effective area to determine spacings and edge distances

**Annex B4**

## Installation instructions

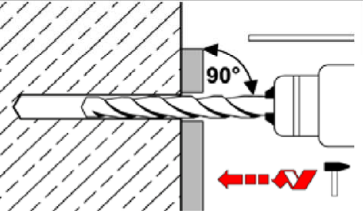
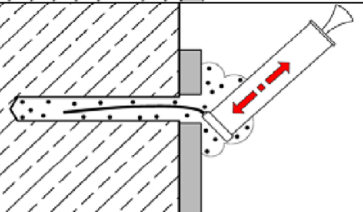
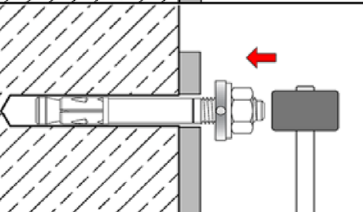
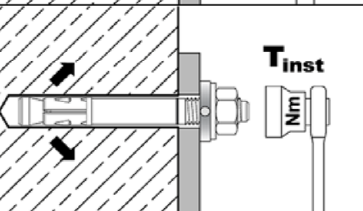
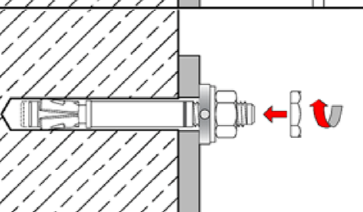
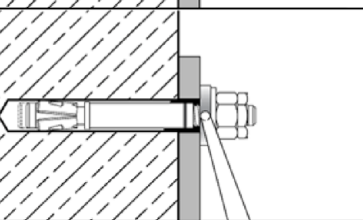
1		<p>Drill hole perpendicular to concrete surface. If using a vacuum drill bit, proceed with step 3.</p>
2		<p>Blow out dust. Alternatively vacuum clean down to the bottom of the hole.</p>
3		<p>Drive in fastener with filling washer until effective anchorage depth is reached.</p>
4		<p>Apply installation torque <math>T_{inst}</math> according to Table B1 by using torque wrench.</p>
5		<p>Screw on locknut until hand tight then tighten <math>\frac{1}{4}</math> to <math>\frac{1}{2}</math> turn.</p>
6		<p>Fill the annular gap between anchor and fixture with mortar (compressive strength <math>\geq 40 \text{ N/mm}^2</math>, e.g. MKT Injection System VMH, VMZ or VMU plus). Use enclosed reducing adapter. Observe the processing information of the mortar! The annular gap is completely filled, when excess mortar seeps out.</p>

**Wedge Anchor BZ3 dynamic**

**Intended use**  
Installation instructions

**Annex B5**

**Table C1: Characteristic values of fatigue resistance**

Anchor size			M10	M12	M16
<b>Tension load</b>					
<b>Steel failure</b>					
Characteristic fatigue resistance	$\Delta N_{Rk,s,0,\infty}$	[kN]	4,6	6,2	9,7
Exponent for combined loading	$\alpha_s$	[-]	0,5	0,5	0,7
Load-transfer factor for fastener groups	$\psi_{FN}$	[-]	0,5		
<b>Pull-out</b>					
Characteristic fatigue resistance	$\Delta N_{Rk,p,0,\infty}$	[kN]	0,5 $N_{Rk,p}$ <sup>1)</sup>		
<b>Concrete cone and splitting failure</b>					
Characteristic fatigue resistance	$\Delta N_{Rk,c,0,\infty}$	[kN]	0,5 $N_{Rk,c}$ <sup>1)</sup>		
	$\Delta N_{Rk,sp,0,\infty}$	[kN]	0,5 $N_{Rk,sp}$ <sup>1)</sup>		
Effective anchorage depth	$h_{ef} \geq$	[mm]	60	70	85
<b>Shear load</b>					
<b>Steel failure without lever arm</b>					
Characteristic fatigue resistance	$\Delta V_{Rk,s,0,\infty}$	[kN]	2,5	4,0	7,5
Exponent for combined loading	$\alpha_s$	[-]	0,5	0,5	0,7
Load-transfer factor for fastener groups	$\psi_{FV}$	[-]	0,5		
<b>Concrete pry-out failure</b>					
Characteristic fatigue resistance	$\Delta V_{Rk,cp,0,\infty}$	[kN]	0,5 $V_{Rk,cp}$ <sup>1)</sup>		
<b>Concrete edge failure</b>					
Characteristic fatigue resistance	$\Delta V_{Rk,c,0,\infty}$	[kN]	0,5 $V_{Rk,c}$ <sup>1)</sup>		
Effective length of anchor	$l_f$	[mm]	60	70	85
Diameter of anchor	$d_{nom}$	[mm]	10	12	16

<sup>1)</sup>  $N_{Rk,c}$ ,  $N_{Rk,p}$ ,  $N_{Rk,sp}$ ,  $V_{Rk,c}$  and  $V_{Rk,cp}$  – Characteristic values of resistance under static or quasi-static actions according to ETA-19/0619 and EN 1992-4:2018

**Wedge Anchor BZ3 dynamic**

**Performance**  
Characteristic values of fatigue resistance

**Annex C1**