

## DECLARACIÓN DE PRESTACIONES

DoP no **MKT-1.4-101**\_es

- ❖ **Código de identificación única del producto tipo:** **Perno ancla BZ3 dynamic**
- ❖ **Usos previstos:** Elementos de fijación en hormigón bajo carga cíclica relacionada con la fatiga, ver Anexo / Annex B
- ❖ **Fabricante:** MKT Metall-Kunststoff-Technik GmbH & Co.KG  
Auf dem Immel 2  
67685 Weilerbach
- Sistemas de evaluación y verificación de la constancia de las prestaciones (EVCP):** 1
- ❖ **Documento de evaluación europeo:** **EAD 330250-00-0601**

valuación técnica europea: **ETA-20/0117, 20.02.2023**

Organismo de evaluación técnica: DIBt, Berlin

Organismos notificados: NB 2873 – Technische Universität Darmstadt
- ❖ **Prestaciones declaradas:**

Características esenciales	Prestaciones
<b>Resistencia mecánica y estabilidad (BWR 1)</b>	
Resistencias características bajo carga de tracción (efectos estáticos y cuasiestáticos)	Anexo/Annex B3, C2, C3
Resistencias características bajo tensión transversal (efectos estáticos y cuasiestáticos)	Anexo/Annex C4
Desplazamientos	Anexo/Annex C8, C9
Resistencias y desplazamientos característicos para las categorías de comportamiento sísmico C1 + C2	Anexo/Annex C5
Durabilidad	Anexo/Annex B1
Resistencia característica a la fatiga bajo cargas de tensión cíclica	Anexo/Annex C1
Resistencia característica a la fatiga bajo cargas transversales cíclicas	
Resistencia característica a la fatiga bajo combinación cíclica tensión extensibles y transversales	
Factor de redistribución de carga para cargas cíclicas de tracción y transversales	
<b>Seguridad en caso de incendio (BWR 2)</b>	
El comportamiento del fuego	Clase A1
Resistencia al fuego	Anexo/Annex C6, C7

Las prestaciones del producto identificado anteriormente son conformes con el conjunto de prestaciones declaradas. La presente declaración de prestaciones se emite, de conformidad con el Reglamento (UE) no 305/2011, bajo la sola responsabilidad del fabricante arriba identificado.

Firmado por y en nombre del fabricante por:



**Stefan Weustenhagen**  
(Director general)  
**Weilerbach, 20.02.2023**

p.p.

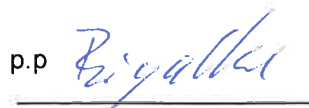

**Dipl.-Ing. Detlef Bigalke**  
(Director de Desarrollo de Productos)



El original de esta declaración de rendimiento fue escrito en alemán. En caso de desviaciones en la traducción, la versión alemana es.

## Specifications of intended use

### Anchorage subject to:

- Fatigue cyclic loading
- Static and quasi-static action, fire exposure and seismic performance according to ETA-19/0619

### Base materials:

- Cracked or uncracked concrete
- Compacted, reinforced or unreinforced normal weight concrete without fibres according to EN 206:2013+A1:2016
- Strength classes C20/25 to C50/60 according to EN 206:2013+A1:2016

### Use conditions (Environmental conditions):

- Structures subject to dry internal conditions
- For all other conditions according to EN 1993-1-2006+A1:2015-10, corresponding to corrosion resistance classes CRC according to Annex A2, Table A2

### Design:

- Anchorages are designed under the responsibility of an engineer experienced in anchorages and concrete work.
- Verifiable calculation notes and drawings are prepared taking account of the loads to be anchored. The position of the fastener is indicated on the design drawings (e.g. position of the fastener relative to reinforcement or to supports, etc.).
- Design method EN 1992-4:2018, TR 055:2018 and TR 061:2020 (design method II)

### Installation:

- Hole drilling by hammer drill bit or vacuum drill bit
- Use of the fastener only as supplied by the manufacturer without exchanging the components of the fastener

**Wedge Anchor BZ3 dynamic**

**Intended use**  
Specifications of intended use

**Annex B1**

**Table B1: Installation parameters**

Anchor size		M10	M12	M16
Nominal drill hole diameter	$d_0 =$ [mm]	10	12	16
Cutting diameter of drill bit	$d_{cut} \leq$ [mm]	10,45	12,5	16,5
Effective anchorage depth <sup>1)</sup>	$h_{ef} \geq$ [mm]	60	70	85
Depth of drill hole	$h_0 \geq$ [mm]	$h_{ef} + 9$	$h_{ef} + 10$	$h_{ef} + 14$
	$h_1 \geq$ [mm]	$h_{ef} + 11$	$h_{ef} + 13$	$h_{ef} + 17$
Diameter of clearance hole in the fixture	$d_f =$ [mm]	12	14	18
Minimum fixture thickness	$t_{fix,min} =$ [mm]	5	6	8
Installation torque	vz $T_{inst} =$ [Nm]	40	60	110
	A4 / HCR $T_{inst} =$ [Nm]	40	55	100
Overstand	$h_p \leq$ [mm]	$21,5 + t_{fix}$	$25,5 + t_{fix}$	$29,5 + t_{fix}$
Length of fastener	L [mm]	$h_{ef} + t_{fix} + 30,5$	$h_{ef} + t_{fix} + 35,5$	$h_{ef} + t_{fix} + 43$
Hexagon nut	width across nut [mm]	17	19	24
Locknut	width across nut [mm]	17	19	24

<sup>1)</sup> End of thread must be above the concrete surface

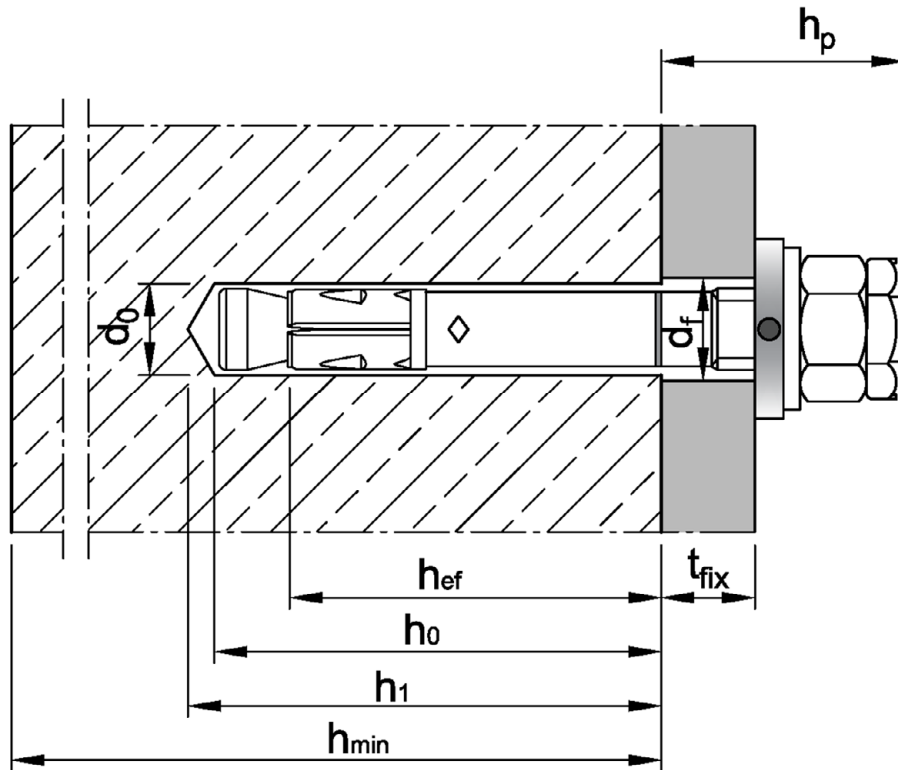

**Wedge Anchor BZ3 dynamic**

**Intended use**  
Installation parameters

**Annex B2**

**Table B2: Minimum thickness of concrete member, minimum spacings, edge distances and required area**

Anchor size			M10	M12	M16
Minimum member thickness depending on $h_{ef}$	$h_{min} \geq$	[mm]	1,5 · $h_{ef}$		
<b>Minimum edge distances and spacings</b>					
Minimum edge distance	$c_{min}$	[mm]	45	55	65
	for $s \geq$	[mm]	see Table B4		
Minimum spacings	$s_{min}$	[mm]	40	50	65
	for $c \geq$	[mm]	see Table B4		
<p><b>The following equation must be fulfilled for the calculation of the minimum spacing and edge distance during installation in connection with the anchorage depth and the member thickness:</b></p> $A_{sp,rqd} \leq A_{sp,ef}$ <p>Required splitting area <math>A_{sp,rqd}</math> and idealized splitting area <math>A_{sp,ef}</math> acc. to Table B4.</p>					

**Table B3: Applicable concrete thickness  $h_{sp}$  and area  $A_{sp}$  to determine characteristic edge distance  $c_{cr,sp}$**

Anchor size			M10	M12	M16
Applicable concrete thickness	$h_{sp}$	[mm]	$\min(h ; h_{ef} + 1,5 \cdot c \cdot \sqrt{2})$		
Area to determine $c_{cr,sp}$	vz	$A_{sp}$	$\frac{N_{Rk,sp}^0 + 2,040}{0,000693}$	$\frac{N_{Rk,sp}^0 + 3,685}{0,000692}$	$\frac{N_{Rk,sp}^0 + 3,738}{0,000875}$
	A4 HCR	$A_{sp}$	$\frac{N_{Rk,sp}^0 + 7,235}{0,000967}$	$\frac{N_{Rk,sp}^0 + 7,847}{0,000951}$	$\frac{N_{Rk,sp}^0 + 11,415}{0,000742}$

**Wedge Anchor BZ3 dynamic**

**Intended use**

Minimum spacings and edge distances  
Required area and applicable concrete thickness

**Annex B3**

**Table B4: Areas to determine spacings and edge distances for installation**

Anchor size		M10	M12	M16		
<p>The following equation must be fulfilled for the calculation of the minimum spacing and edge distance during installation in combination with variable anchorage depth and member thickness:</p> $A_{sp,rqd} \leq A_{sp,ef}$						
<p><b>Idealized splitting area <math>A_{sp,ef}</math></b>                      The spacings and edge distances shall be selected or rounded in steps of 5 mm.</p>						
<p><b>Member thickness: <math>h &gt; h_{ef} + 1,5 \cdot c</math></b></p>						
<p>Single anchor or anchor group with <math>s \geq 3 \cdot c</math></p>						
Effective anchorage depth	$h_{ef} < 1,5 \cdot c$	$A_{sp,ef} = (6 \cdot c) \cdot (1,5 \cdot c + h_{ef})$		[mm <sup>2</sup> ]		
Effective anchorage depth	$h_{ef} \geq 1,5 \cdot c$	$A_{sp,ef} = (6 \cdot c) \cdot (3 \cdot c)$		[mm <sup>2</sup> ]		
<p>Anchor group (<math>s &lt; 3 \cdot c</math>)</p>						
Effective anchorage depth	$h_{ef} < 1,5 \cdot c$	$A_{sp,ef} = (3 \cdot c + s) \cdot (1,5 \cdot c + h_{ef})$		[mm <sup>2</sup> ]		
Effective anchorage depth	$h_{ef} \geq 1,5 \cdot c$	$A_{sp,ef} = (3 \cdot c + s) \cdot (3 \cdot c)$		[mm <sup>2</sup> ]		
<p><b>Member thickness: <math>h \leq h_{ef} + 1,5 \cdot c</math></b></p>						
<p>Single anchor or anchor group with <math>s \geq 3 \cdot c</math></p>						
Effective anchorage depth	$h_{ef} < 1,5 \cdot c$	$A_{sp,ef} = (6 \cdot c) \cdot h$		[mm <sup>2</sup> ]		
Effective anchorage depth	$h_{ef} \geq 1,5 \cdot c$	$A_{sp,ef} = (6 \cdot c) \cdot (h - h_{ef} + 1,5 \cdot c)$		[mm <sup>2</sup> ]		
<p>Anchor group (<math>s &lt; 3 \cdot c</math>)</p>						
Effective anchorage depth	$h_{ef} < 1,5 \cdot c$	$A_{sp,ef} = (3 \cdot c + s) \cdot h$		[mm <sup>2</sup> ]		
Effective anchorage depth	$h_{ef} \geq 1,5 \cdot c$	$A_{sp,ef} = (3 \cdot c + s) \cdot (h - h_{ef} + 1,5 \cdot c)$		[mm <sup>2</sup> ]		
<p><b>Required splitting area <math>A_{sp,rqd}</math></b></p>						
vz	cracked concrete	$A_{sp,rqd}$	[mm <sup>2</sup> ]	23 700	31 500	42 300
	uncracked concrete	$A_{sp,rqd}$	[mm <sup>2</sup> ]	34 700	41 300	50 200
A4 HCR	cracked concrete	$A_{sp,rqd}$	[mm <sup>2</sup> ]	25 900	29 800	44 300
	uncracked concrete	$A_{sp,rqd}$	[mm <sup>2</sup> ]	35 700	35 300	54 800

**Wedge Anchor BZ3 dynamic**

**Intended use**  
 Areas to determine spacings and edge distances

**Annex B4**

## Installation instructions

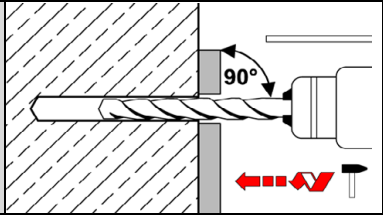
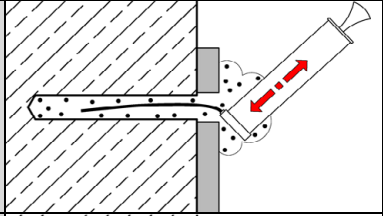
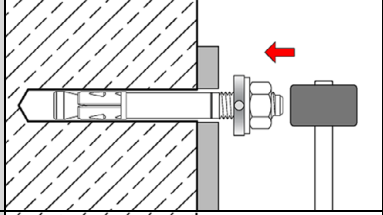
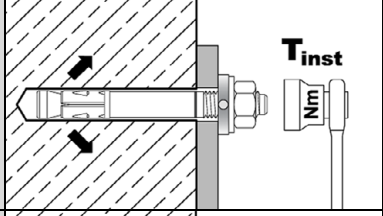
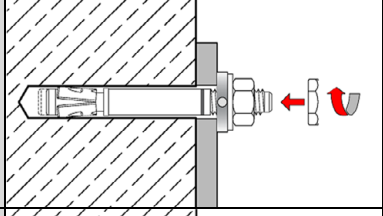
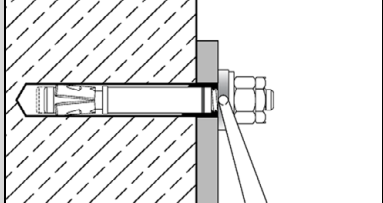
1		<p>Drill hole perpendicular to concrete surface. If using a vacuum drill bit, proceed with step 3.</p>
2		<p>Blow out dust. Alternatively, vacuum clean down to the bottom of the hole.</p>
3		<p>Drive in fastener with filling washer until effective anchorage depth is reached.</p>
4		<p>Apply installation torque <math>T_{inst}</math> according to Table B1 by using torque wrench.</p>
5		<p>Screw on locknut until hand tight then tighten <math>\frac{1}{4}</math> to <math>\frac{1}{2}</math> turn.</p>
6		<p>Fill the annular gap between anchor and fixture with mortar (compressive strength <math>\geq 40 \text{ N/mm}^2</math>, e.g. MKT Injection System VMH, VMZ or VMU plus). Use enclosed reducing adapter. Observe the processing information of the mortar! The annular gap is completely filled, when excess mortar seeps out.</p>

### Wedge Anchor BZ3 dynamic

Intended use  
Installation instructions

Annex B5

**Table C1: Characteristic values of fatigue resistance**

Anchor size				M10	M12	M16	
<b>Tension load</b>							
<b>Steel failure</b>							
Characteristic fatigue resistance	vZ	$\Delta N_{Rk,s,0,\infty}$	[kN]	4,6	6,2	9,7	
	A4		[kN]	3,2	5,3	9,2	
	HCR		[kN]	2,8	5,5	9,7	
Load-transfer factor for fastener groups			$\Psi_{FN}$	[-]			
<b>Pull-out</b>							
Characteristic fatigue resistance			$\Delta N_{Rk,p,0,\infty}$	[kN]	0,5 $N_{Rk,p}$		
<b>Concrete cone and splitting failure</b>							
Characteristic fatigue resistance			$\Delta N_{Rk,c,0,\infty}$	[kN]	0,5 $N_{Rk,c}$		
			$\Delta N_{Rk,sp,0,\infty}$	[kN]	0,5 $N_{Rk,sp}$		
Effective anchorage depth			$h_{ef}$	[mm]	60	70	85
<b>Shear load</b>							
<b>Steel failure without lever arm</b>							
Characteristic fatigue resistance	vZ	$\Delta V_{Rk,s,0,\infty}$	[kN]	2,5	4,0	7,5	
	A4		[kN]	1,5	2,8	6,0	
	HCR		[kN]	2,3	2,8	5,0	
Load-transfer factor for fastener groups			$\Psi_{FV}$	[-]			
<b>Concrete pry-out failure</b>							
Characteristic fatigue resistance			$\Delta V_{Rk,cp,0,\infty}$	[kN]	0,5 $V_{Rk,cp}$		
<b>Concrete edge failure</b>							
Characteristic fatigue resistance			$\Delta V_{Rk,c,0,\infty}$	[kN]	0,5 $V_{Rk,c}$		
Effective length of anchor			$l_f$	[mm]	60	70	85
Diameter of anchor			$d_{nom}$	[mm]	10	12	16
<b>Tension and shear load</b>							
Partial factor <sup>1)</sup>	$\gamma_{Ms,fat}$		[-]	1,35			
	$\gamma_{Mc,fat}$		[-]	1,5			
	$\gamma_{Msp,fat}$		[-]	1,5			
	$\gamma_{Mp,fat}$		[-]	1,5			
Exponents for combined loading			$\alpha_s$	[-]	0,5	0,5	0,7
			$\alpha_c$	[-]	1,5		

<sup>1)</sup> In absence of other national regulations

**Wedge Anchor BZ3 dynamic**

**Performance**  
Characteristic values of fatigue resistance

**Annex C1**

**Table C2: Characteristic values for tension loads under static and quasi-static action, steel, zinc plated**

Anchor size			M10	M12	M16
Installation factor	$\gamma_{inst}$	[-]	1,0		
<b>Steel failure</b>					
Characteristic resistance	$N_{Rk,s}$	[kN]	30,4	44,9	79,3
Partial factor <sup>1)</sup>	$\gamma_{Ms}$	[-]	1,5		
<b>Pull-out</b>					
Characteristic resistance in cracked concrete C20/25	$N_{Rk,p,cr}$	[kN]	15	22	30
Increasing factor $N_{Rk,p,cr} = \psi_C \cdot N_{Rk,p,cr} (C20/25)$	$\psi_C$	[-]	$\left(\frac{f_{ck}}{20}\right)^{0,265}$	$\left(\frac{f_{ck}}{20}\right)^{0,5}$	$\left(\frac{f_{ck}}{20}\right)^{0,339}$
Characteristic resistance in uncracked concrete C20/25	$N_{Rk,p,ucr}$	[kN]	24	30	50
Increasing factor $N_{Rk,p,ucr} = \psi_C \cdot N_{Rk,p,ucr} (C20/25)$	$\psi_C$	[-]	$\left(\frac{f_{ck}}{20}\right)^{0,448}$	$\left(\frac{f_{ck}}{20}\right)^{0,5}$	$\left(\frac{f_{ck}}{20}\right)^{0,203}$
<b>Splitting</b>					
Characteristic resistance	$N^0_{Rk,sp}$	[kN]	$\min(N_{Rk,p}; N^0_{Rk,c}{}^3)$		
Characteristic edge distance <sup>2)</sup>	$C_{cr,sp}$	[mm]	$\frac{A_{sp} + 0,8 \cdot (h_{sp} - h_{ef})^2}{(3,41 \cdot h_{sp} - 0,59 \cdot h_{ef})}$		
Characteristic spacing	$S_{cr,sp}$	[mm]	$2 \cdot C_{cr,sp}$		
<b>Concrete cone failure</b>					
Effective anchorage depth	$h_{ef}$	[mm]	60	70	85
Characteristic edge distance	$C_{cr,N}$	[mm]	$1,5 \cdot h_{ef}$		
Characteristic spacing	$S_{cr,N}$	[mm]	$2 \cdot C_{cr,N}$		
Factor	cracked concrete	$k_{cr,N}$	7,7		
	uncracked concrete	$k_{ucr,N}$	11,0		

<sup>1)</sup> In absence of other national regulations

<sup>2)</sup> Applicable concrete thickness  $h_{sp}$  and area  $A_{sp}$  to determine characteristic edge distance  $C_{cr,sp}$  according to Table B3

<sup>3)</sup>  $N^0_{Rk,c}$  according to EN 1992-4:2018

**Wedge Anchor BZ3 dynamic**

**Performance**

Characteristic values for **tension loads, steel, zinc plated**

**Annex C2**



**Table C3:** Characteristic values for **tension loads** under static or quasi-static action, **A4** and **HCR**

Anchor size			M10	M12	M16
Installation factor	$\gamma_{inst}$	[-]	1,0		
<b>Steel failure</b>					
Characteristic resistance	$N_{RK,s}$	[kN]	30,4	44,9	74,6
Partial factor <sup>1)</sup>	$\gamma_{Ms}$	[-]	1,5		
<b>Pull-out</b>					
Characteristic resistance in cracked concrete C20/25	$N_{RK,p,cr}$	[kN]	17	22	35
Increasing factor $N_{RK,p,cr} = \psi_C \cdot N_{RK,p,cr} (C20/25)$	$\psi_C$	[-]	$\left(\frac{f_{ck}}{20}\right)^{0,5}$	$\left(\frac{f_{ck}}{20}\right)^{0,435}$	$\left(\frac{f_{ck}}{20}\right)^{0,350}$
Characteristic resistance in uncracked concrete C20/25	$N_{RK,p,ucr}$	[kN]	25	42	50
Increasing factor $N_{RK,p,ucr} = \psi_C \cdot N_{RK,p,ucr} (C20/25)$	$\psi_C$	[-]	$\left(\frac{f_{ck}}{20}\right)^{0,364}$	$\left(\frac{f_{ck}}{20}\right)^{0,213}$	$\left(\frac{f_{ck}}{20}\right)^{0,196}$
<b>Splitting</b>					
Characteristic resistance	$N^0_{RK,sp}$	[kN]	$\min(N_{RK,p}; N^0_{RK,c} \text{ } ^3)$		
Characteristic edge distance <sup>2)</sup>	$C_{cr,sp}$	[mm]	$\frac{A_{sp} + 0,8 \cdot (h_{sp} - h_{ef})^2}{(3,41 \cdot h_{sp} - 0,59 \cdot h_{ef})}$		
Characteristic spacing	$S_{cr,sp}$	[mm]	$2 \cdot C_{cr,sp}$		
<b>Concrete cone failure</b>					
Effective anchorage depth	$h_{ef}$	[mm]	60	70	85
Characteristic edge distance	$C_{cr,N}$	[mm]	$1,5 \cdot h_{ef}$		
Characteristic spacing	$S_{cr,N}$	[mm]	$2 \cdot C_{cr,N}$		
Factor	cracked concrete	$k_{cr,N}$	7,7		
	uncracked concrete	$k_{ucr,N}$	11,0		

<sup>1)</sup> In absence of other national regulations

<sup>2)</sup> Applicable concrete thickness  $h_{sp}$  and area  $A_{sp}$  according to Table B3 to determine characteristic edge distance  $C_{cr,sp}$

<sup>3)</sup>  $N^0_{RK,c}$  according to EN 1992-4:2018

**Wedge Anchor BZ3 dynamic**

**Performance**

Characteristic values for **tension loads, A4** and **HCR**

**Annex C3**

**Table C4:** Characteristic values for **shear loads** under static and quasi-static action

Anchor size				M10	M12	M16
Installation factor		$\gamma_{inst}$	[-]	1,0		
<b>Steel failure <u>without</u> lever arm</b>						
Characteristic resistance	vZ	$V^0_{Rk,s}$	[kN]	26,8	38,3	60,0
	A4 / HCR	$V^0_{Rk,s}$	[kN]	27,8	39,8	69,5
Partial factor <sup>1)</sup>		$\gamma_{Ms}$	[-]	1,25		
Ductility factor		$k_7$	[-]	1,0		
<b>Steel failure <u>with</u> lever arm</b>						
Characteristic bending resistance	vZ	$M^0_{Rk,s}$	[Nm]	60	105	240
	A4 / HCR	$M^0_{Rk,s}$	[Nm]	55	99	223
Partial factor <sup>1)</sup>		$\gamma_{Ms}$	[-]	1,25		
<b>Concrete pry-out failure</b>						
Pry-out factor	vZ	$k_8$	[-]	3,1	3,0	3,6
	A4 / HCR	$k_8$	[-]	2,8	3,3	3,4
<b>Concrete edge failure</b>						
Effective length of fastener in shear loading		$l_f$	[mm]	$h_{ef}$		
Outside diameter of fastener		$d_{nom}$	[mm]	10	12	16

<sup>1)</sup> In absence of other national regulations

<b>Wedge Anchor BZ3 dynamic</b>	<b>Annex C4</b>
<b>Performance</b> Characteristic values for <b>shear loads</b>	

**Table C5: Characteristic values for seismic loading, performance category C1**

Anchor size				M10	M12	M16
Effective anchorage depth	$h_{ef} \geq$	[mm]		60	70	85
<b>Tension load</b>						
Installation factor	$\gamma_{inst}$	[-]		1,0		
<b>Steel failure</b>						
Characteristic resistance	VZ	$N_{Rk,s,C1}$	[kN]	30,4	44,9	79,3
	A4 / HCR	$N_{Rk,s,C1}$	[kN]	30,4	44,9	74,6
<b>Pull-out</b>						
Characteristic resistance	VZ	$N_{Rk,p,C1}$	[kN]	15,0	22,0	30,0
	A4 / HCR	$N_{Rk,p,C1}$	[kN]	17,0	22,0	35,0
<b>Shear load</b>						
<b>Steel failure without lever arm</b>						
Characteristic resistance	VZ	$V_{Rk,s,C1}$	[kN]	24,4	33,8	52,3
	A4 / HCR	$V_{Rk,s,C1}$	[kN]	22,2	33,2	64,3
Factor for anchorages without annular gap	$\alpha_{gap}$	[-]		1,0		

**Table C6: Characteristic values for seismic loading, performance category C2**

Anchor size				M10	M12	M16
Effective anchorage depth	$h_{ef} \geq$	[mm]		60	70	85
<b>Tension load</b>						
Installation factor	$\gamma_{inst}$	[-]		1,0		
<b>Steel failure</b>						
Characteristic resistance	VZ	$N_{Rk,s,C2}$	[kN]	30,4	44,9	79,3
	A4 / HCR	$N_{Rk,s,C2}$	[kN]	30,4	44,9	74,6
<b>Pull-out</b>						
Characteristic resistance	VZ	$N_{Rk,p,C2}$	[kN]	12,5	19,0	35,2
	A4 / HCR	$N_{Rk,p,C2}$	[kN]	7,7	13,8	29,4
<b>Shear load</b>						
<b>Steel failure without lever arm</b>						
Characteristic resistance	VZ	$V_{Rk,s,C2}$	[kN]	19,0	28,0	43,3
	A4 / HCR	$V_{Rk,s,C2}$	[kN]	15,9	25,6	46,1
Factor for anchorages without annular gap	$\alpha_{gap}$	[-]		1,0		

**Wedge Anchor BZ3 dynamic**
**Performance**  
 Characteristic resistance for **seismic loading**
**Annex C5**

**Table C7: Characteristic values for tension and shear load under fire exposure, steel, zinc plated**

Anchor size				M10	M12	M16
<b>Tension load</b>						
<b>Steel failure</b>						
Characteristic resistance	R30	$N_{Rk,s,fi}$	[kN]	2,6	4,6	7,7
	R60			1,9	3,3	5,6
	R90			1,3	2,1	3,5
	R120			1,0	1,5	2,5
<b>Shear load</b>						
<b>Steel failure <u>without</u> lever arm</b>						
Characteristic resistance	R30	$V_{Rk,s,fi}$	[kN]	7,5	12,3	20,7
	R60			5,1	8,5	14,2
	R90			2,7	4,6	7,7
	R120			1,6	2,7	4,5
<b>Steel failure <u>with</u> lever arm</b>						
Characteristic resistance	R30	$M^0_{Rk,s,fi}$	[Nm]	9,6	19,1	43,8
	R60			6,6	13,1	30,1
	R90			3,5	7,2	16,4
	R120			2,0	4,2	9,6

$N_{Rk,p,fi}$  and  $N_{Rk,c,fi}$  according to EN 1992-4:2018

**Wedge Anchor BZ3 dynamic**

**Performance**

Characteristic values under **fire exposure, steel, zinc plated**

**Annex C6**

**Table C8: Characteristic values for tension and shear load under fire exposure, A4 and HCR**

Anchor size				M10	M12	M16
<b>Tension load</b>						
<b>Steel failure</b>						
Characteristic resistance	R30	$N_{Rk,s,fi}$	[kN]	6,9	11,0	18,1
	R60			5,0	8,0	13,1
	R90			3,1	4,9	8,1
	R120			2,1	3,4	5,6
<b>Shear load</b>						
<b>Steel failure <u>without</u> lever arm</b>						
Characteristic resistance	R30	$V_{Rk,s,fi}$	[kN]	17,6	32,0	52,6
	R60			12,6	22,6	37,1
	R90			7,5	13,1	21,5
	R120			5,0	8,4	13,8
<b>Steel failure <u>with</u> lever arm</b>						
Characteristic resistance	R30	$M^0_{Rk,s,fi}$	[Nm]	22,7	49,8	111,5
	R60			16,2	35,1	78,6
	R90			9,7	20,4	45,6
	R120			6,5	13,0	29,2

$N_{Rk,p,fi}$  and  $N_{Rk,c,fi}$  according to EN 1992-4:2018

**Wedge Anchor BZ3 dynamic**

**Performance**

Characteristic values under **fire exposure, A4 and HCR**

**Annex C7**

**Table C9: Displacements under tension load, steel, zinc plated**

Anchor size			M10	M12	M16
<b>Displacements under static or quasi-static action</b>					
$\delta_{N0} = \delta_{N0\text{-factor}} \cdot N$ N: acting tension load					
$\delta_{N\infty} = \delta_{N\infty\text{-factor}} \cdot N$					
<b>Cracked concrete</b>					
Factor for displacement	$\delta_{N0\text{-factor}}$	[mm/kN]	0,05	0,04	0,03
	$\delta_{N\infty\text{-factor}}$	[mm/kN]	0,20	0,15	0,11
<b>Uncracked concrete</b>					
Factor for displacement	$\delta_{N0\text{-factor}}$	[mm/kN]	0,01	0,004	0,005
	$\delta_{N\infty\text{-factor}}$	[mm/kN]	0,03	0,03	0,03
<b>Displacement under seismic action C2</b>					
Displacements for DLS	$\delta_{N,C2(DLS)}$	[mm]	4,7	4,2	4,5
Displacements for ULS	$\delta_{N,C2(ULS)}$	[mm]	16,1	12,9	12,8

**Table C10: Displacements under tension load, A4 and HCR**

Anchor size			M10	M12	M16
<b>Displacements under static or quasi-static action</b>					
$\delta_{N0} = \delta_{N0\text{-factor}} \cdot N$ N: acting tension load					
$\delta_{N\infty} = \delta_{N\infty\text{-factor}} \cdot N$					
<b>Cracked concrete</b>					
Factor for displacement	$\delta_{N0\text{-factor}}$	[mm/kN]	0,06	0,05	0,02
	$\delta_{N\infty\text{-factor}}$	[mm/kN]	0,17	0,16	0,08
<b>Uncracked concrete</b>					
Factor for displacement	$\delta_{N0\text{-factor}}$	[mm/kN]	0,00	0,001	0,00
	$\delta_{N\infty\text{-factor}}$	[mm/kN]	0,05	0,05	0,05
<b>Displacement under seismic action C2</b>					
Displacements for DLS	$\delta_{N,C2(DLS)}$	[mm]	4,1	5,7	5,1
Displacements for ULS	$\delta_{N,C2(ULS)}$	[mm]	16,8	18,0	13,9

**Wedge Anchor BZ3 dynamic****Performance**

Displacements under tension load

**Annex C8**

