

SUORITUSTASOILMOITUS

DoP Nro: **MKT-1.1-100_fi**

- ◇ **Tuotetyypin yksilöllinen tunniste:** **Kiila-ankkuri BZ plus ja BZ-IG**
- ◇ **Aiottu käyttötarkoitus (aiotut käyttötarkoitukset):** Voimakäyttöinen ankkurointi ankkurointiin betoniin, ks. Liite / Annex B
- ◇ **Valmistaja:** MKT Metall-Kunststoff-Technik GmbH & Co.KG
Auf dem Immel 2
67685 Weilerbach
- ◇ **Suoritustason pysyvyyden arvioinnissa ja varmentamisessa käytetty järjestelmä/käytetyt järjestelmät:** 1
- ◇ **Eurooppalainen arviointiasiakirja:** **EAD 330232-00-0601**
Eurooppalainen tekninen arviointi: **ETA-99/0010, 23.07.2018**
Teknisestä arvioinnista vastaava laitos: DIBt, Berlin
Ilmoitettu laitos/ilmoitetut laitokset: NB 2873 – Technische Universität Darmstadt

◇ **Ilmoitettu suoritusaste/ilmoitetut suoritusastot:**

Olennaiset ominaisuudet	Suoritusaste
Mekaaninen lujuus ja vakaus (BWR 1)	
Karakteristiset vastukset staattisille ja kvasi-staattisille kuormille	BZ plus: Liite/Annex C1 – C5 BZ-IG: Liite/Annex C11 – C13
Vuorossa	BZ plus: Liite/Annex C9 – C10 BZ-IG: Liite/Annex C15
Ominaisvastukset seismisten suorituskykyluokkien C1 + C2 osalta	BZ plus: Liite/Annex C6
Paloturvallisuus (BWR 2)	
Palokäyttäytyminen	Luokka A1
Palonkestävyys	BZ plus: Liite/Annex C7 – C8 BZ-IG: Liite/Annex C14

Edellä yksilöidyn tuotteen suoritusaste on ilmoitettujen suoritusasteojen joukon mukainen. Tämä suoritusasteoilmoitus on asetuksen (EU) N:o 305/2011 mukaisesti annettu edellä ilmoitetun valmistajan yksinomaisella vastuulla.

Valmistajan puolesta allekirjoittanut:

Stefan Weustenhagen
(Toimitusjohtaja)
Weilerbach, 01.01.2021

p.p. 
Dipl.-Ing. Detlef Bigalke
(Tuotekehityksen johtaja)



Tämän suoritusasteoilmoituksen alkuperäinen teksti on kirjoitettu saksaksi. Jos käännökset poikkeavat toisistaan, saksankielinen versio on pätevä.

Specifications of intended use

Wedge Anchor BZ plus							
Standard anchorage depth	M8	M10	M12	M16	M20	M24	M27
Steel, galvanized				✓			
Steel, sherardized				✓			
Stainless steel A4 and high corrosion resistant steel HCR			✓				-
Static or quasi-static action				✓			
Fire exposure				✓			
Seismic action (C1 and C2) ¹⁾			✓			-	-
Reduced anchorage depth ¹⁾	M8	M10	M12	M16			
Steel, galvanized			✓				
Steel, sherardized			✓				
Stainless steel A4 and high corrosion resistant steel HCR			✓				
Static or quasi-static action			✓				
Fire exposure			✓				
Seismic action (C1 and C2)			-				

¹⁾ only cold formed anchors acc. to Annex A3

Wedge Anchor BZ-IG				
	M6	M8	M10	M12
Steel, galvanized			✓	
Stainless steel A4 and high corrosion resistant steel HCR			✓	
Static or quasi-static action			✓	
Fire exposure			✓	
Seismic action (C1 and C2)			-	

Base materials:

- Compacted, reinforced or unreinforced normal weight concrete (without fibers) according to EN 206:2013
- Strength classes C20/25 to C50/60 according to EN 206:2013
- Cracked or uncracked concrete

Use conditions (Environmental conditions):

- Structures subject to dry internal conditions (steel zinc plated, stainless steel or high corrosion resistant steel).
- Structures subject to external atmospheric exposure including industrial and marine environment or exposure to permanently damp internal condition, if no particular aggressive conditions exist (stainless steel or high corrosion resistant steel).
- Structures subject to external atmospheric exposure and to permanently damp internal condition, if other particular aggressive conditions (high corrosion resistant steel)

Note: Particular aggressive conditions are e.g. permanent, alternating immersion in seawater or the splash zone of seawater, chloride atmosphere of indoor pools or atmosphere with extreme chemical pollution (e.g. in desulphurization plants or road tunnels where de-icing materials are used.)

Wedge Anchor BZ plus and BZ-IG

Intended use
Specifications

Annex B1

Specifications of intended use

Design:

- Anchorages are designed under the responsibility of an engineer experienced in anchorages and concrete work
- Verifiable calculation notes and drawings are prepared taking account of the loads to be anchored. The position of the fastener is indicated on the design drawings (e.g. position of the fastener relative to reinforcement or to supports, etc.).
- Dimensioning of fasteners under static or quasi-static action, seismic action or fire exposure according to FprEN 1992-4: 2016 in conjunction with TR 055

Installation:

- Fastener installation carried out by appropriately qualified personnel and under the supervision of the person responsible for technical matters of the site
- Hole drilling by hammer drill bit or vacuum drill bit
- Use of the fastener only as supplied by the manufacturer without exchanging the components of the fastener
- Optionally, the annular gap between fixture and stud of the BZ plus can be filled to reduce the hole. For this purpose, the filling washer (3b) must be used in addition to the supplied washer (3a). For filling use high-strength mortar with compressive strength $\geq 50\text{N/mm}^2$ (VMZ, VMU plus or VMH)
- In case of aborted hole: new drilling at a minimum distance away of twice the depth of the aborted hole or smaller distance if the aborted drill hole is filled with high strength mortar and if under shear or oblique tension load it is not in the direction of load application

Wedge Anchor BZ plus and BZ-IG

Intended use
Specifications

Annex B2

Table B1: Installation parameters, BZ plus

Fastener size			M8	M10	M12	M16	M20	M24	M27	
Nominal drill hole diameter	d_0	[mm]	8	10	12	16	20	24	28	
Cutting diameter of drill bit	$d_{cut} \leq$	[mm]	8,45	10,45	12,5	16,5	20,55	24,55	28,55	
Installation torque	Steel, galvanized	T_{inst}	[Nm]	20	25	45	90	160	200	300
	Steel, sherardized	T_{inst}	[Nm]	16	22	40	90	160	260	300
	Stainless steel A4, HCR	T_{inst}	[Nm]	20	35	50	110	200	290	-
Diameter of clearance hole in the fixture	$d_f \leq$	[mm]	9	12	14	18	22	26	30	
Standard anchorage depth										
Depth of drill hole	Steel, zinc plated	$h_1 \geq$	[mm]	60	75	90	110	125	145	160
	Stainless steel A4, HCR	$h_1 \geq$	[mm]	60	75	90	110	125	155	-
Effective anchorage depth	Steel, zinc plated	h_{ef}	[mm]	46	60	70	85	100	115	125
	Stainless steel A4, HCR	h_{ef}	[mm]	46	60	70	85	100	125	-
Reduced anchorage depth										
Depth of drill hole	$h_{1,red} \geq$	[mm]	49	55	70	90	-	-	-	
Reduced effective anchorage depth	$h_{ef,red}$	[mm]	35	40	50	65	-	-	-	

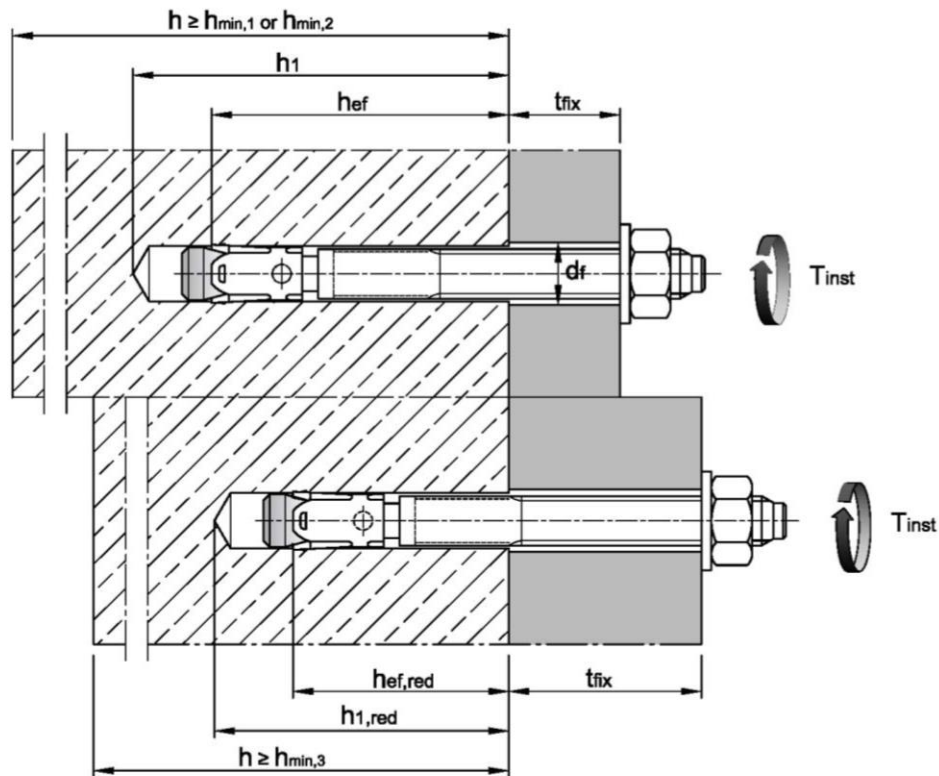

Wedge anchor BZ plus

Intended use
Installation parameters

Annex B3

Table B2: Minimum spacings and edge distances, standard anchorage depth, BZ plus

Fastener size			M8	M10	M12	M16	M20	M24	M27
Standard thickness of concrete member									
Steel zinc plated									
Standard thickness of member	$h_{min,1}$	[mm]	100	120	140	170	200	230	250
Cracked concrete									
Minimum spacing	S_{min}	[mm]	40	45	60	60	95	100	125
	für $c \geq$	[mm]	70	70	100	100	150	180	300
Minimum edge distance	C_{min}	[mm]	40	45	60	60	95	100	180
	für $s \geq$	[mm]	80	90	140	180	200	220	540
Uncracked concrete									
Minimum spacing	S_{min}	[mm]	40	45	60	65	90	100	125
	für $c \geq$	[mm]	80	70	120	120	180	180	300
Minimum edge distance	C_{min}	[mm]	50	50	75	80	130	100	180
	für $s \geq$	[mm]	100	100	150	150	240	220	540
Stainless steel A4, HCR									
Standard thickness of member	$h_{min,1}$	[mm]	100	120	140	160	200	250	-
Cracked concrete									
Minimum spacing	S_{min}	[mm]	40	50	60	60	95	125	-
	für $c \geq$	[mm]	70	75	100	100	150	125	
Minimum edge distance	C_{min}	[mm]	40	55	60	60	95	125	
	für $s \geq$	[mm]	80	90	140	180	200	125	
Uncracked concrete									
Minimum spacing	S_{min}	[mm]	40	50	60	65	90	125	-
	für $c \geq$	[mm]	80	75	120	120	180	125	
Minimum edge distance	C_{min}	[mm]	50	60	75	80	130	125	
	für $s \geq$	[mm]	100	120	150	150	240	125	
Minimum thickness of concrete member									
Steel zinc plated, stainless steel A4, HCR									
Minimum thickness of member	$h_{min,2}$	[mm]	80	100	120	140	-	-	-
Cracked concrete									
Minimum spacing	S_{min}	[mm]	40	45	60	70	-	-	-
	für $c \geq$	[mm]	70	90	100	160			
Minimum edge distance	C_{min}	[mm]	40	50	60	80			
	für $s \geq$	[mm]	80	115	140	180			
Uncracked concrete									
Minimum spacing	S_{min}	[mm]	40	60	60	80	-	-	-
	für $c \geq$	[mm]	80	140	120	180			
Minimum edge distance	C_{min}	[mm]	50	90	75	90			
	für $s \geq$	[mm]	100	140	150	200			
Fire exposure from one side									
Minimum spacing	$S_{min,fi}$	[mm]	See normal ambient temperature						
Minimum edge distance	$C_{min,fi}$	[mm]	See normal ambient temperature						
Fire exposure from more than one side									
Minimum spacing	$S_{min,fi}$	[mm]	See normal ambient temperature						
Minimum edge distance	$C_{min,fi}$	[mm]	≥ 300 mm						

Intermediate values by linear interpolation.

Wedge anchor BZ plus

Intended use
Minimum spacings and edge distances for standard anchorage depth

Annex B4

Table B3: Minimum spacings and edge distances, reduced anchorage depth, BZ plus

Fastener size			M8	M10	M12	M16
Minimum thickness of concrete member	$h_{min,3}$	[mm]	80	80	100	140
Cracked concrete						
Minimum spacing	s_{min}	[mm]	50	50	50	65
	für $c \geq$	[mm]	60	100	160	170
Minimum edge distance	c_{min}	[mm]	40	65	65	100
	für $s \geq$	[mm]	185	180	250	250
Uncracked concrete						
Minimum spacing	s_{min}	[mm]	50	50	50	65
	für $c \geq$	[mm]	60	100	160	170
Minimum edge distance	c_{min}	[mm]	40	65	100	170
	für $s \geq$	[mm]	185	180	185	65
Fire exposure from one side						
Minimum spacing	$s_{min,fi}$	[mm]	See normal ambient temperature			
Minimum edge distance	$c_{min,fi}$	[mm]	See normal ambient temperature			
Fire exposure from more than one side						
Minimum spacing	$s_{min,fi}$	[mm]	See normal ambient temperature			
Minimum edge distance	$c_{min,fi}$	[mm]	≥ 300 mm			

Intermediate values by linear interpolation.

Wedge anchor BZ plus

Intended use
Minimum **spacings** and **edge distances** for **reduced anchorage depth**

Annex B5

Installation instructions BZ plus

1		<p>Drill hole perpendicular to concrete surface. If using a vacuum drill bit, proceed with step 3.</p>
2		<p>Blow out dust. Alternatively vacuum clean down to the bottom of the hole.</p>
3		<p>Check position of nut.</p>
4		<p>Drive in fastener, such that h_{ef} or $h_{ef,red}$ depth is met. This compliance is ensured, if the thickness of fixture is not greater than the maximum thickness of fixture marked on the fastener in accordance with Annex A3.</p>
5		<p>Installation torque T_{inst} shall be applied by using calibrated torque wrench.</p>

Wedge anchor BZ plus

Intended Use
Installation instructions

Annex B6

Installation instructions BZ plus with filling of annular gap

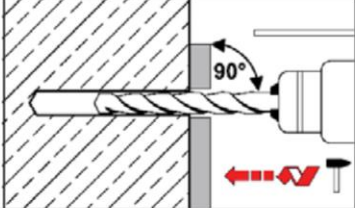
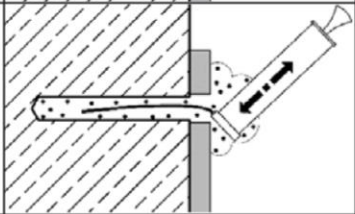
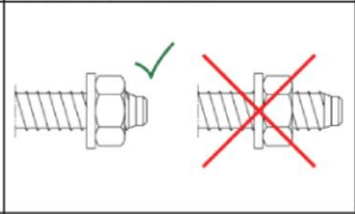
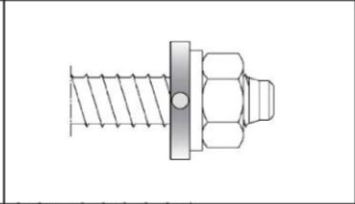
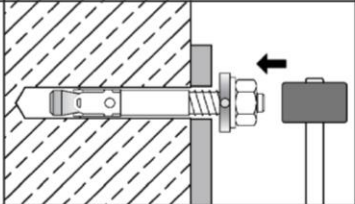
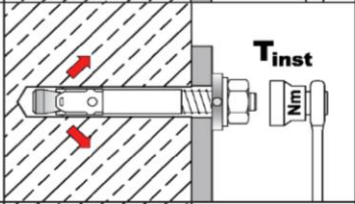
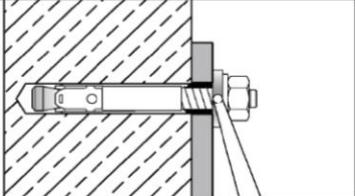
1		<p>Drill hole perpendicular to concrete surface. If using a vacuum drill bit, proceed with step 3a.</p>
2		<p>Blow out dust. Alternatively vacuum clean down to the bottom of the hole.</p>
3a		<p>Check position of nut.</p>
3b		<p>Fit the filling washer to the fastener. The thickness of the filling washer must be taken into account with t_{fix}.</p>
4		<p>Drive in fastener with filling washer, such that h_{ef} or $h_{ef,red}$ depth is met. This compliance is ensured, if the thickness of fixture is 5mm smaller than the maximum thickness of fixture marked on the fastener in accordance with Annex A3.</p>
5		<p>Installation torque T_{inst} shall be applied by using calibrated torque wrench.</p>
6		<p>Fill the annular gap between stud and fixture with mortar (compressive strength $\geq 50 \text{ N/mm}^2$ VMH, VMZ or VMU plus). Use enclosed reducing adapter. Observe the processing information of the mortar! The annular gap is completely filled, when excess mortar seeps out.</p>

Wedge anchor BZ plus

Intended Use

Installation instructions with filling washer

Annex B7

Table B4: Installation parameters BZ-IG

Fastener size			M6	M8	M10	M12	
Effective anchorage depth	h_{ef}	[mm]	45	58	65	80	
Drill hole diameter	d_0	[mm]	8	10	12	16	
Cutting diameter of drill bit	$d_{cut} \leq$	[mm]	8,45	10,45	12,5	16,5	
Depth of drill hole	$h_1 \geq$	[mm]	60	75	90	105	
Screwing depth of threaded rod	$L_{sd}^{2)} \geq$	[mm]	9	12	15	18	
Installation torque, steel zinc plated	T_{inst}	S	[Nm]	10	30	30	55
		SK	[Nm]	10	25	40	50
		B	[Nm]	8	25	30	45
Installation torque, stainless steel A4, HCR	T_{inst}	S	[Nm]	15	40	50	100
		SK	[Nm]	12	25	45	60
		B	[Nm]	8	25	40	80
Pre-setting installation							
Diameter of clearance hole in the fixture	$d_f \leq$	[mm]	7	9	12	14	
Minimum thickness of fixture	$t_{fix} \geq$	S	[mm]	1	1	1	1
		SK	[mm]	5	7	8	9
		B	[mm]	1	1	1	1
Through-setting installation							
Diameter of clearance hole in the fixture	$d_f \leq$	[mm]	9	12	14	18	
Minimum thickness of fixture ¹⁾	$t_{fix} \geq$	S	[mm]	5	7	8	9
		SK	[mm]	9	12	14	16
		B	[mm]	5	7	8	9

¹⁾ The minimum thickness of fixture can be reduced to the value of Pre-setting installation, if the shear load at steel failure is designed with lever arm.

²⁾ see Annex A5

Table B5: Minimum spacings and edge distances BZ-IG

Fastener size			M6	M8	M10	M12
Minimum thickness of concrete member	h_{min}	[mm]	100	120	130	160
Cracked concrete						
Minimum spacing	s_{min}	[mm]	50	60	70	80
	für $c \geq$	[mm]	60	80	100	120
Minimum edge distance	c_{min}	[mm]	50	60	70	80
	für $s \geq$	[mm]	75	100	100	120
Uncracked concrete						
Minimum spacing	s_{min}	[mm]	50	60	65	80
	für $c \geq$	[mm]	80	100	120	160
Minimum edge distance	c_{min}	[mm]	50	60	70	100
	für $s \geq$	[mm]	115	155	170	210
Fire exposure from one side						
Minimum spacing	$s_{min,fi}$	[mm]	See normal temperature			
Minimum edge distance	$c_{min,fi}$	[mm]	See normal temperature			
Fire exposure from more than one side						
Minimum spacing	$s_{min,fi}$	[mm]	See normal temperature			
Minimum edge distance	$c_{min,fi}$	[mm]	≥ 300 mm			

Intermediate values by linear interpolation.

Wedge anchor BZ-IG**Intended use**

Installation parameters, minimum spacings and edge distances **BZ-IG**

Annex B8

Installation instructions **BZ-IG**

Pre-setting installation

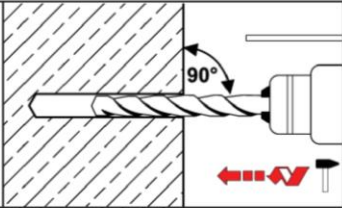
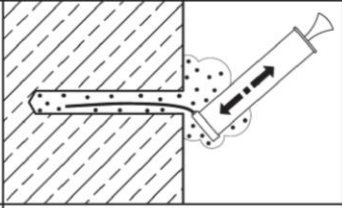
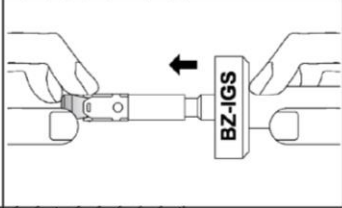
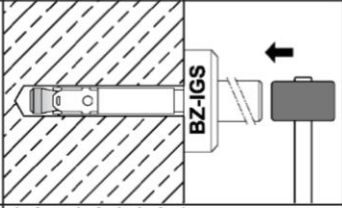
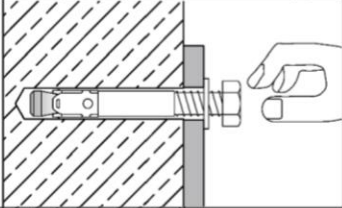
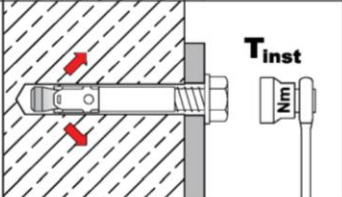
1		Drill hole perpendicular to concrete surface. If using vacuum drill bit, proceed with step 3.
2		Blow out dust. Alternatively vacuum clean down to the bottom of the hole.
3		Setting tool for pre-setting installation insert in fastener.
4		Drive in fastener with setting tool.
5		Drive in screw.
6		Installation torque T_{inst} may be applied by using calibrated torque wrench.

Wedge anchor **BZ-IG**

Intended Use
Installation instructions for pre-setting installation **BZ-IG**

Annex B9

Installation instructions **BZ-IG**

Through-setting installation

1		Drill hole perpendicular to concrete surface. If using a vacuum drill bit, proceed with step 3.
2		Blow out dust. Alternatively vacuum clean down to the bottom of the hole.
3		Setting tool for through-setting installation insert in fastener.
4		Drive in fastener with setting tool.
5		Drive in screw.
6		Installation torque T_{inst} may be applied by using calibrated torque wrench.

Wedge anchor **BZ-IG**

Intended Use

Installation instructions for through-setting installation **BZ-IG**

Annex B10

Table C1: Characteristic values for tension loads, BZ plus zinc plated, cracked concrete, static and quasi-static action

Fastener size		M8	M10	M12	M16	M20	M24	M27
Installation factor	γ_{inst} [-]	1,0						
Steel failure								
Characteristic resistance	$N_{Rk,s}$ [kN]	16	27	40	60	86	126	196
Partial factor	γ_{Ms} [-]	1,53		1,5		1,6	1,5	
Pull-out								
Standard anchorage depth								
Characteristic resistance in cracked concrete C20/25	$N_{Rk,p}$ [kN]	5	9	16	25	1)	1)	1)
Reduced anchorage depth								
Characteristic resistance in cracked concrete C20/25	$N_{Rk,p}$ [kN]	5	7,5	1)	1)	-	-	-
Increasing factor for $N_{Rk,p}$	ψ_C [-]	$\left(\frac{f_{ck}}{20}\right)^{0,5}$						
Concrete cone failure								
Effective anchorage depth	h_{ef} [mm]	46	60	70	85	100	115	125
Reduced anchorage depth	$h_{ef,red}$ [mm]	35 2)	40	50	65	-	-	-
Factor for cracked concrete	$k_1 = k_{Cr,N}$ [-]	7,7						

1) Pull-out is not decisive

2) Use restricted to anchoring of structural components statically indeterminate

Wedge anchor BZ plus

Performance

Characteristic values for **tension loads, BZ plus zinc plated, cracked concrete**, static and quasi-static action

Annex C1

Table C2: Characteristic values for tension loads, BZ plus A4 / HCR, cracked concrete, static and quasi-static action

Fastener size		M8	M10	M12	M16	M20	M24
Installation factor	γ_{inst} [-]	1,0					
Steel failure							
Characteristic resistance	$N_{Rk,s}$ [kN]	16	27	40	64	108	110
Partial factor	γ_{Ms} [-]	1,5				1,68	1,5
Pull-out							
Standard anchorage depth							
Characteristic resistance in cracked concrete C20/25	$N_{Rk,p}$ [kN]	5	9	16	25	1) ¹⁾	40
Reduced anchorage depth							
Characteristic resistance in cracked concrete C20/25	$N_{Rk,p}$ [kN]	5	7,5	1) ¹⁾	1) ¹⁾	-	-
Increasing factor for $N_{Rk,p}$	ψ_c [-]	$\left(\frac{f_{ck}}{20}\right)^{0,5}$					
Concrete cone failure							
Effective anchorage depth	h_{ef} [mm]	46	60	70	85	100	125
Reduced anchorage depth	$h_{ef,red}$ [mm]	35 ²⁾	40	50	65	-	-
Factor for cracked concrete	$k_1 = k_{cr,N}$ [-]	7,7					

¹⁾ Pull-out is not decisive

²⁾ Use restricted to anchoring of structural components statically indeterminate

Wedge anchor BZ plus

Performance

Characteristic values for **tension loads, BZ plus A4 / HCR, cracked concrete**, static and quasi-static action

Annex C2

Table C3: Characteristic values for tension loads, BZ plus zinc plated, uncracked concrete, static and quasi-static action

Fastener size		M8	M10	M12	M16	M20	M24	M27
Installation factor	γ_{inst} [-]	1,0						
Steel failure								
Characteristic resistance	$N_{Rk,s}$ [kN]	16	27	40	60	86	126	196
Partial factor	γ_{Ms} [-]	1,53		1,5		1,6	1,5	
Pull-out								
Standard anchorage depth								
Characteristic resistance in uncracked concrete C20/25	$N_{Rk,p}$ [kN]	12	16	25	35	1)	1)	1)
Reduced anchorage depth								
Characteristic resistance in uncracked concrete C20/25	$N_{Rk,p}$ [kN]	7,5	9	1)	1)	-	-	-
Splitting								
Standard anchorage depth								
Splitting for standard thickness of concrete member (The higher resistance of case 1 and case 2 may be applied; $C_{cr,sp}$ may be linearly interpolated for the member thickness $h_{min,2} < h < h_{min,1}$ (Case 2); $\psi_{h,sp} = 1,0$)								
Standard thickness of concrete	$h_{min,1} \geq$ [mm]	100	120	140	170	200	230	250
Case 1								
Characteristic resistance in uncracked concrete C20/25	$N^0_{Rk,sp}$ [kN]	9	12	20	30	40	62,3	50
Edge distance	$C_{cr,sp}$ [mm]	1,5 h_{ef}						
Case 2								
Characteristic resistance in uncracked concrete C20/25	$N^0_{Rk,sp}$ [kN]	12	16	25	35	50,5	62,3	70,6
Edge distance	$C_{cr,sp}$ [mm]	2 h_{ef}				2,2 h_{ef}	1,5 h_{ef}	2,5 h_{ef}
Splitting for minimum thickness of concrete member								
Minimum thickness of concrete	$h_{min,2} \geq$ [mm]	80	100	120	140			
Characteristic resistance in uncracked concrete C20/25	$N^0_{Rk,sp}$ [kN]	12	16	25	35	-	-	-
Edge distance	$C_{cr,sp}$ [mm]	2,5 h_{ef}						
Reduced anchorage depth								
Minimum thickness of concrete	$h_{min,3} \geq$ [mm]	80	80	100	140			
Characteristic resistance in uncracked concrete C20/25	$N^0_{Rk,sp}$ [kN]	7,5	9	17,9	26,5	-	-	-
Edge distance	$C_{cr,sp}$ [mm]	100	100	125	150			
Increasing factor for $N_{Rk,p}$ and $N^0_{Rk,sp}$	ψ^c [-]	$\left(\frac{f_{ck}}{20}\right)^{0,5}$						
Concrete cone failure								
Effective anchorage depth	h_{ef} [mm]	46	60	70	85	100	115	125
Reduced anchorage depth	$h_{ef,red}$ [mm]	35 ²⁾	40	50	65	-	-	-
Factor for uncracked concrete	$k_1 = k_{Ucr,N}$ [-]	11,0						

1) Pull-out is not decisive

2) Use restricted to anchoring of structural components statically indeterminate

Wedge anchor BZ plus

Performance

Characteristic values for **tension loads, BZ plus zinc plated, uncracked concrete**, static and quasi-static action

Annex C3

Table C4: Characteristic values for **tension loads**, BZ plus **A4 / HCR**, **uncracked concrete**, static and quasi-static action

Fastener size			M8	M10	M12	M16	M20	M24
Installation factor	γ_{inst}	[-]	1,0					
Steel failure								
Characteristic resistance	$N_{Rk,s}$	[kN]	16	27	40	64	108	110
Partial factor	γ_{Ms}	[-]	1,5				1,68	1,5
Pull-out								
Standard anchorage depth								
Characteristic resistance in uncracked concrete C20/25	$N_{Rk,p}$	[kN]	12	16	25	35	1)	1)
Reduced anchorage depth								
Characteristic resistance in uncracked concrete C20/25	$N_{Rk,p}$	[kN]	7,5	9	1)	1)	-	-
Splitting								
Standard anchorage depth								
<u>Splitting for standard thickness of concrete member</u> (The higher resistance of case 1 and case 2 may be applied; $C_{cr,sp}$ may be linearly interpolated for the member thickness $h_{min,2} < h < h_{min,1}$ (Case 2); $\psi_{h,sp} = 1,0$)								
Standard thickness of concrete	$h_{min,1} \geq$	[mm]	100	120	140	160	200	250
Case 1								
Characteristic resistance in uncracked concrete C20/25	$N^0_{Rk,sp}$	[kN]	9	12	20	30	40	-
Edge distance	$C_{cr,sp}$	[mm]	1,5 h_{ef}					
Case 2								
Characteristic resistance in uncracked concrete C20/25	$N^0_{Rk,sp}$	[kN]	12	16	25	35	50,5	70,6
Edge distance	$C_{cr,sp}$	[mm]	115	125	140	200	220	250
<u>Splitting for minimum thickness of concrete member</u>								
Minimum thickness of concrete	$h_{min,2} \geq$	[mm]	80	100	120	140	-	-
Characteristic resistance in uncracked concrete C20/25	$N^0_{Rk,sp}$	[kN]	12	16	25	35		
Edge distance	$C_{cr,sp}$	[mm]	2,5 h_{ef}					
Reduced anchorage depth								
Minimum thickness of concrete	$h_{min,3} \geq$	[mm]	80	80	100	140	-	-
Characteristic resistance in uncracked concrete C20/25	$N^0_{Rk,sp}$	[kN]	7,5	9	17,9	26,5		
Edge distance	$C_{cr,sp}$	[mm]	100	100	125	150		
Increasing factor for $N_{Rk,p}$ and $N^0_{Rk,sp}$	ψ_c	[-]	$\left(\frac{f_{ck}}{20}\right)^{0,5}$					
Concrete cone failure								
Effective anchorage depth	h_{ef}	[mm]	46	60	70	85	100	125
Reduced anchorage depth	$h_{ef,red}$	[mm]	35 ²⁾	40	50	65	-	-
Factor for uncracked concrete	$k_1 = k_{ucr,N}$	[-]	11,0					

1) Pull-out is not decisive

2) Use restricted to anchoring of structural components statically indeterminate

Wedge anchor BZ plus

Performance

Characteristic values for **tension loads**, BZ plus **A4 / HCR**, **uncracked concrete**, static and quasi-static action

Annex C4

Table C5: Characteristic values for **shear loads**, BZ plus,
cracked and uncracked concrete, static or quasi static action

Fastener size			M8	M10	M12	M16	M20	M24	M27	
Installation factor	γ_{inst}	[-]	1,0							
Steel failure without lever arm, Steel zinc plated										
Characteristic resistance	$V^0_{Rk,s}$	[kN]	12,2	20,1	30	55	69	114	169,4	
Ductility factor	k_7	[-]	1,0							
Partial factor	γ_{Ms}	[-]	1,25				1,33	1,25	1,25	
Steel failure without lever arm, Stainless steel A4, HCR										
Characteristic resistance	$V^0_{Rk,s}$	[kN]	13	20	30	55	86	123,6	-	
Ductility factor	k_7	[-]	1,0							
Partial factor	γ_{Ms}	[-]	1,25				1,4	1,25		
Steel failure with lever arm, Steel zinc plated										
Characteristic bending resistance	$M^0_{Rk,s}$	[Nm]	23	47	82	216	363	898	1331,5	
Partial factor	γ_{Ms}	[-]	1,25				1,33	1,25	1,25	
Steel failure with lever arm, Stainless steel A4, HCR										
Characteristic bending resistance	$M^0_{Rk,s}$	[Nm]	26	52	92	200	454	785,4	-	
Partial factor	γ_{Ms}	[-]	1,25				1,4	1,25		
Concrete pry-out failure										
Pry-out factor	k_8	[-]	2,4				2,8			
Concrete edge failure										
Effective length of fastener in shear loading with h_{ef}	Steel zinc plated	l_f	[mm]	46	60	70	85	100	115	125
	Stainless steel A4, HCR	l_f	[mm]	46	60	70	85	100	125	-
Effective length of fastener in shear loading with $h_{ef,red}$	Steel zinc plated	$l_{f,red}$	[mm]	35 ¹⁾	40	50	65	-	-	-
	Stainless steel A4, HCR	$l_{f,red}$	[mm]	35 ¹⁾	40	50	65			
Outside diameter of fastener	d_{nom}	[mm]	8	10	12	16	20	24	27	

¹⁾ Use restricted to anchoring of structural components statically indeterminate

Wedge anchor BZ plus

Performance

Characteristic values for **shear loads**, BZ plus,
cracked and uncracked concrete, static or quasi static action

Annex C5

Table C6: Characteristic resistance for **seismic loading**, BZ plus,
standard anchorage depth, performance category **C1** and **C2**

Fastener size		M8	M10	M12	M16	M20	
Tension loads							
Installation factor	γ_{inst}	[-]	1,0				
Steel failure, Steel zinc plated							
Characteristic resistance C1	$N_{Rk,s,eq,C1}$	[kN]	16	27	40	60	86
Characteristic resistance C2	$N_{Rk,s,eq,C2}$	[kN]	16	27	40	60	86
Partial factor	γ_{Ms}	[-]	1,53		1,5		1,6
Steel failure, Stainless steel A4, HCR							
Characteristic resistance C1	$N_{Rk,s,eq,C1}$	[kN]	16	27	40	64	108
Characteristic resistance C2	$N_{Rk,s,eq,C2}$	[kN]	16	27	40	64	108
Partial factor	γ_{Ms}	[-]	1,5				1,68
Pull-out (steel zinc plated, stainless steel A4 and HCR)							
Characteristic resistance C1	$N_{Rk,p,eq,C1}$	[kN]	5	9	16	25	36
Characteristic resistance C2	$N_{Rk,p,eq,C2}$	[kN]	2,3	3,6	10,2	13,8	24,4
Shear loads							
Steel failure without lever arm, Steel zinc plated							
Characteristic resistance C1	$V_{Rk,s,eq,C1}$	[kN]	9,3	20	27	44	69
Characteristic resistance C2	$V_{Rk,s,eq,C2}$	[kN]	6,7	14	16,2	35,7	55,2
Partial factor	γ_{Ms}	[-]	1,25				1,33
Steel failure without lever arm, Stainless steel A4, HCR							
Characteristic resistance C1	$V_{Rk,s,eq,C1}$	[kN]	9,3	20	27	44	69
Characteristic resistance C2	$V_{Rk,s,eq,C2}$	[kN]	6,7	14	16,2	35,7	55,2
Partial factor	γ_{Ms}	[-]	1,25				1,4
Factor for annular gap	without filling of annular gap	α_{gap}	[-]	0,5			
	with filling of annular gap	α_{gap}	[-]	1,0			

Wedge anchor BZ plus

Performance

Characteristic resistance for **seismic loading**, BZ plus,
standard anchorage depth, performance category **C1** and **C2**

Annex C6

Table C7: Characteristic values for tension and shear load under fire exposure, BZ plus, standard anchorage depth, cracked and uncracked concrete C20/25 to C50/60

Fastener size		M8	M10	M12	M16	M20	M24	M27		
Tension load										
Steel failure										
Steel, zinc plated										
Characteristic resistance	R30	$N_{Rk,s,fi}$	[kN]	1,5	2,6	4,1	7,7	9,4	13,6	17,6
	R60			1,1	1,9	3,0	5,6	8,2	11,8	15,3
	R90			0,8	1,4	2,4	4,4	6,9	10,0	13,0
	R120			0,7	1,2	2,2	4,0	6,3	9,1	11,8
Stainless steel A4, HCR										
Characteristic resistance	R30	$N_{Rk,s,fi}$	[kN]	3,8	6,9	12,7	23,7	33,5	48,2	-
	R60			2,9	5,3	9,4	17,6	25,0	35,9	
	R90			2,0	3,6	6,1	11,5	16,4	23,6	
	R120			1,6	2,8	4,5	8,4	12,1	17,4	
Shear load										
Steel failure without lever arm										
Steel, zinc plated										
Characteristic resistance	R30	$V_{Rk,s,fi}$	[kN]	1,6	2,6	4,1	7,7	11	16	20,6
	R60			1,5	2,5	3,6	6,8	11	15	19,8
	R90			1,2	2,1	3,5	6,5	10	15	19,0
	R120			1,0	2,0	3,4	6,4	10	14	18,6
Stainless steel A4, HCR										
Characteristic resistance	R30	$V_{Rk,s,fi}$	[kN]	3,8	6,9	12,7	23,7	33,5	48,2	-
	R60			2,9	5,3	9,4	17,6	25,0	35,9	
	R90			2,0	3,6	6,1	11,5	16,4	23,6	
	R120			1,6	2,8	4,5	8,4	12,1	17,4	
Steel failure with lever arm										
Steel, zinc plated										
Characteristic resistance	R30	$M^0_{Rk,s,fi}$	[Nm]	1,7	3,3	6,4	16,3	29	50	75
	R60			1,6	3,2	5,6	14	28	48	72
	R90			1,2	2,7	5,4	14	27	47	69
	R120			1,1	2,5	5,3	13	26	46	68
Stainless steel A4, HCR										
Characteristic resistance	R30	$M^0_{Rk,s,fi}$	[Nm]	3,8	9,0	19,7	50,1	88,8	153,5	-
	R60			2,9	6,8	14,6	37,2	66,1	114,3	
	R90			2,1	4,7	9,5	24,2	43,4	75,1	
	R120			1,6	3,6	7,0	17,8	32,1	55,5	

If pull-out is not decisive, $N_{Rk,p}$ must be replaced by $N^0_{Rk,c}$ in equation (D.4) and (D.5), FprEN 1992-4.

Wedge anchor BZ plus

Performance

Characteristic values for tension and shear load under fire exposure, BZ plus, standard anchorage depth, cracked and uncracked concrete C20/25 to C50/60

Annex C7

Table C8: Characteristic values for tension and shear load under fire exposure, BZ plus, reduced anchorage depth, cracked and uncracked concrete C20/25 to C50/60

Fastener size		M8	M10	M12	M16		
Tension load							
Steel failure							
Steel, zinc plated							
Characteristic resistance	R30	$N_{Rk,s,fi}$	[kN]	1,5	2,6	4,1	7,7
	R60			1,1	1,9	3,0	5,6
	R90			0,8	1,3	1,9	3,5
	R120			0,6	1,0	1,3	2,5
Stainless steel A4, HCR							
Characteristic resistance	R30	$N_{Rk,s,fi}$	[kN]	3,2	6,9	12,7	23,7
	R60			2,5	5,3	9,4	17,6
	R90			1,9	3,6	6,1	11,5
	R120			1,6	2,8	4,5	8,4
Shear load							
Steel failure without lever arm							
Steel, zinc plated							
Characteristic resistance	R30	$V_{Rk,s,fi}$	[kN]	1,5	2,6	4,1	7,7
	R60			1,1	1,9	3,0	5,6
	R90			0,8	1,3	1,9	3,5
	R120			0,6	1,0	1,3	2,5
Stainless steel A4, HCR							
Characteristic resistance	R30	$V_{Rk,s,fi}$	[kN]	3,2	6,9	12,7	23,7
	R60			2,5	5,3	9,4	17,6
	R90			1,9	3,6	6,1	11,5
	R120			1,6	2,8	4,5	8,4
Steel failure with lever arm							
Steel, zinc plated							
Characteristic resistance	R30	$M^0_{Rk,s,fi}$	[Nm]	1,5	3,3	6,4	16,3
	R60			1,2	2,5	4,7	11,9
	R90			0,8	1,7	3,0	7,5
	R120			0,6	1,2	2,1	5,3
Stainless steel A4, HCR							
Characteristic resistance	R30	$M^0_{Rk,s,fi}$	[Nm]	3,2	8,9	19,7	50,1
	R60			2,6	6,8	14,6	37,2
	R90			2,0	4,7	9,5	24,2
	R120			1,6	3,6	7,0	17,8

If pull-out is not decisive, $N_{Rk,p}$ must be replaced by $N^0_{Rk,c}$ in equation (D.4) and (D.5), FprEN 1992-4.

Wedge anchor BZ plus

Performance

Characteristic values for tension and shear load under fire exposure, BZ plus, reduced anchorage depth, cracked and uncracked concrete C20/25 to C50/60

Annex C8

Table C9: Displacements under tension load, BZ plus

Fastener size			M8	M10	M12	M16	M20	M24	M27
Standard anchorage depth									
Steel zinc plated									
Tension load in cracked concrete	N	[kN]	2,4	4,3	7,6	11,9	17,1	21,1	24
Displacement	δ_{N0}	[mm]	0,6	1,0	0,4	1,0	0,9	0,7	0,9
	$\delta_{N\infty}$	[mm]	1,4	1,2	1,4	1,3	1,0	1,2	1,4
Tension load in uncracked concrete	N	[kN]	5,7	7,6	11,9	16,7	23,8	29,6	34
Displacement	δ_{N0}	[mm]	0,4	0,5	0,7	0,3	0,4	0,5	0,3
	$\delta_{N\infty}$	[mm]	0,8		1,4	0,8		1,4	
Displacements under seismic tension loads C2									
Displacements for DLS	$\delta_{N,eq,(DLS)}$	[mm]	2,3	4,1	4,9	3,6	5,1	-	-
Displacements for ULS	$\delta_{N,eq,(ULS)}$	[mm]	8,2	13,8	15,7	9,5	15,2	-	-
Stainless steel A4, HCR									
Tension load in cracked concrete	N	[kN]	2,4	4,3	7,6	11,9	17,1	19,0	-
Displacement	δ_{N0}	[mm]	0,7	1,8	0,4	0,7	0,9	0,5	
	$\delta_{N\infty}$	[mm]	1,2	1,4	1,4	1,4	1,0	1,8	
Tension load in uncracked concrete	N	[kN]	5,8	7,6	11,9	16,7	23,8	33,5	-
Displacement	δ_{N0}	[mm]	0,6	0,5	0,7	0,2	0,4	0,5	
	$\delta_{N\infty}$	[mm]	1,2	1,0	1,4	0,4	0,8	1,1	
Displacements under seismic tension loads C2									
Displacements for DLS	$\delta_{N,eq,(DLS)}$	[mm]	2,3	4,1	4,9	3,6	5,1	-	-
Displacements for ULS	$\delta_{N,eq,(ULS)}$	[mm]	8,2	13,8	15,7	9,5	15,2	-	-
Reduced anchorage depth									
Steel zinc plated, stainless steel A4, HCR									
Tension load in cracked concrete	N	[kN]	2,4	3,6	6,1	9,0	-	-	-
Displacement	δ_{N0}	[mm]	0,8	0,7	0,5	1,0			
	$\delta_{N\infty}$	[mm]	1,2	1,0	0,8	1,1			
Tension load in uncracked concrete	N	[kN]	3,7	4,3	8,5	12,6	-	-	-
Displacement	δ_{N0}	[mm]	0,1	0,2	0,2	0,2			
	$\delta_{N\infty}$	[mm]	0,7	0,7	0,7	0,7			

Wedge anchor BZ plus
Performance
 Displacements under tension load

Annex C9

Table C10: Displacements under shear load, BZ plus

Fastener size			M8	M10	M12	M16	M20	M24	M27
Standard anchorage depth									
Steel zinc plated									
Shear load in cracked and uncracked concrete	V	[kN]	6,9	11,4	17,1	31,4	36,8	64,9	96,8
Displacement	δ_{V0}	[mm]	2,0	3,2	3,6	3,5	1,8	3,5	3,6
	$\delta_{V\infty}$	[mm]	3,0	4,7	5,5	5,3	2,7	5,3	5,4
Displacements under seismic shear loads C2									
Displacements for DLS	$\delta_{V,eq(DLS)}$	[mm]	3,0	2,7	3,5	4,3	4,7	-	-
Displacements for ULS	$\delta_{V,eq(ULS)}$	[mm]	5,9	5,3	9,5	9,6	10,1	-	-
Stainless steel A4, HCR									
Shear load in cracked and uncracked concrete	V	[kN]	7,3	11,4	17,1	31,4	43,8	70,6	-
Displacement	δ_{V0}	[mm]	1,9	2,4	4,0	4,3	2,9	2,8	-
	$\delta_{V\infty}$	[mm]	2,9	3,6	5,9	6,4	4,3	4,2	-
Displacements under seismic shear loads C2									
Displacements for DLS	$\delta_{V,eq(DLS)}$	[mm]	3,0	2,7	3,5	4,3	4,7	-	-
Displacements for ULS	$\delta_{V,eq(ULS)}$	[mm]	5,9	5,3	9,5	9,6	10,1	-	-
Reduced anchorage depth									
Steel zinc plated									
Shear load in cracked and uncracked concrete	V	[kN]	6,9	11,4	17,1	31,4	-	-	-
Displacement	δ_{V0}	[mm]	2,0	3,2	3,6	3,5	-	-	-
	$\delta_{V\infty}$	[mm]	3,0	4,7	5,5	5,3	-	-	-
Stainless steel A4, HCR									
Shear load in cracked and uncracked concrete	V	[kN]	7,3	11,4	17,1	31,4	-	-	-
Displacement	δ_{V0}	[mm]	1,9	2,4	4,0	4,3	-	-	-
	$\delta_{V\infty}$	[mm]	2,9	3,6	5,9	6,4	-	-	-

Wedge anchor BZ plus

Performance
Displacements under shear load

Annex C10

Table C11: Characteristic values for **tension loads, BZ-IG, cracked concrete**, static and quasi-static action

Fastener size			M6	M8	M10	M12
Installation factor	γ_{inst}	[-]	1,2			
Steel failure						
Characteristic resistance, steel zinc plated	$N_{Rk,s}$	[kN]	16,1	22,6	26,0	56,6
Partial factor	γ_{Ms}	[-]	1,5			
Characteristic resistance, stainless steel A4, HCR	$N_{Rk,s}$	[kN]	14,1	25,6	35,8	59,0
	γ_{Ms}	[-]	1,87			
Pull-out failure						
Characteristic resistance in cracked concrete C20/25	$N_{Rk,p}$	[kN]	5	9	12	20
Increasing factor for $N_{Rk,p}$	ψ_c	[-]	$\left(\frac{f_{ck}}{20}\right)^{0,5}$			
Concrete cone failure						
Effective anchorage depth	h_{ef}	[mm]	45	58	65	80
Factor for cracked concrete	$k_1 = k_{cr,N}$	[-]	7,7			

Wedge anchor BZ-IG

Performance

Characteristic values for **tension loads, BZ-IG, cracked concrete**, static and quasi-static action

Annex C11

Table C12: Characteristic values for **tension loads, BZ-IG, uncracked concrete**, static and quasi-static action

Fastener size			M6	M8	M10	M12
Installation factor	γ_{inst}	[-]	1,2			
Steel failure						
Characteristic resistance, steel zinc plated	$N_{Rk,s}$	[kN]	16,1	22,6	26,0	56,6
Partial factor	γ_{Ms}	[-]	1,5			
Characteristic resistance, stainless steel A4, HCR	$N_{Rk,s}$	[kN]	14,1	25,6	35,8	59,0
Partial factor	γ_{Ms}	[-]	1,87			
Pull-out						
Characteristic resistance in uncracked concrete C20/25	$N_{Rk,p}$	[kN]	12	16	20	30
Splitting (the higher resistance of Case 1 and Case 2 may be applied)						
Minimum thickness of concrete member	h_{min}	[mm]	100	120	130	160
Case 1						
Characteristic resistance in uncracked concrete C20/25	$N^0_{Rk,sp}$	[kN]	9	12	16	25
Edge distance	$C_{cr,sp}$	[mm]	1,5 h_{ef}			
Case 2						
Characteristic resistance in uncracked concrete C20/25	$N^0_{Rk,sp}$	[kN]	12	16	20	30
Edge distance	$C_{cr,sp}$	[mm]	2,5 h_{ef}			
Increasing factor for $N_{Rk,p}$ and $N^0_{Rk,sp}$	ψ_c	[-]	$\left(\frac{f_{ck}}{20}\right)^{0,5}$			
Concrete cone failure						
Effective anchorage depth	h_{ef}	[mm]	45	58	65	80
Factor for uncracked concrete	$k_1 = k_{ucr,N}$	[-]	11,0			

Wedge anchor BZ-IG

Performance

Characteristic values for **tension loads, BZ-IG, uncracked concrete**, static and quasi-static action

Annex C12

Table C13: Characteristic values for shear loads, BZ-IG, cracked and uncracked concrete, static and quasi-static action

Fastener size			M6	M8	M10	M12
Installation factor	γ_{inst}	[-]	1,0			
BZ-IG, steel zinc plated						
Steel failure without lever arm, Pre-setting installation						
Characteristic resistance	$V_{RK,s}^0$	[kN]	5,8	6,9	10,4	25,8
Steel failure without lever arm, Through-setting installation						
Characteristic resistance	$V_{RK,s}^0$	[kN]	5,1	7,6	10,8	24,3
Steel failure with lever arm, Pre-setting installation						
Characteristic bending resistance	$M_{RK,s}^0$	[Nm]	12,2	30,0	59,8	104,6
Steel failure with lever arm, Through-setting installation						
Characteristic bending resistance	$M_{RK,s}^0$	[Nm]	36,0	53,2	76,0	207
Partial factor for $V_{RK,s}$ and $M_{RK,s}^0$	γ_{Ms}	[-]	1,25			
Ductility factor	k_7	[-]	1,0			
BZ-IG, stainless steel A4, HCR						
Steel failure without lever arm, Pre-setting installation						
Characteristic resistance	$V_{RK,s}^0$	[kN]	5,7	9,2	10,6	23,6
Partial factor	γ_{Ms}	[-]	1,25			
Steel failure without lever arm, Through-setting installation						
Characteristic resistance	$V_{RK,s}^0$	[kN]	7,3	7,6	9,7	29,6
Partial factor	γ_{Ms}	[-]	1,25			
Steel failure with lever arm, Pre-setting installation						
Characteristic bending resistance	$M_{RK,s}^0$	[Nm]	10,7	26,2	52,3	91,6
Partial factor	γ_{Ms}	[-]	1,56			
Steel failure with lever arm, Through-setting installation						
Characteristic bending resistance	$M_{RK,s}^0$	[Nm]	28,2	44,3	69,9	191,2
Partial factor	γ_{Ms}	[-]	1,25			
Ductility factor	k_7	[-]	1,0			
Concrete pry-out failure						
Pry-out factor	k_8	[-]	1,5	1,5	2,0	2,0
Concrete edge failure						
Effective length of fastener in shear loading	l_f	[mm]	45	58	65	80
Effective diameter of fastener	d_{nom}	[mm]	8	10	12	16

Wedge anchor BZ-IG

Performance

Characteristic values for shear loads, BZ-IG, cracked and uncracked concrete, static and quasi-static action

Annex C13

Table C14: Characteristic values for **tension** and **shear load** under **fire exposure, BZ-IG**, cracked and uncracked concrete C20/25 to C50/60

Fastener size		M6	M8	M10	M12		
Tension load							
Steel failure							
Steel zinc plated							
Characteristic resistance	R30	$N_{Rk,s,fi}$	[kN]	0,7	1,4	2,5	3,7
	R60			0,6	1,2	2,0	2,9
	R90			0,5	0,9	1,5	2,2
	R120			0,4	0,8	1,3	1,8
Stainless steel A4, HCR							
Characteristic resistance	R30	$N_{Rk,s,fi}$	[kN]	2,9	5,4	8,7	12,6
	R60			1,9	3,8	6,3	9,2
	R90			1,0	2,1	3,9	5,7
	R120			0,5	1,3	2,7	4,0
Shear load							
Steel failure without lever arm							
Steel zinc plated							
Characteristic resistance	R30	$V_{Rk,s,fi}$	[kN]	0,7	1,4	2,5	3,7
	R60			0,6	1,2	2,0	2,9
	R90			0,5	0,9	1,5	2,2
	R120			0,4	0,8	1,3	1,8
Stainless steel A4, HCR							
Characteristic resistance	R30	$V_{Rk,s,fi}$	[kN]	2,9	5,4	8,7	12,6
	R60			1,9	3,8	6,3	9,2
	R90			1,0	2,1	3,9	5,7
	R120			0,5	1,3	2,7	4,0
Steel failure with lever arm							
Steel zinc plated							
Characteristic resistance	R30	$M^0_{Rk,s,fi}$	[Nm]	0,5	1,4	3,3	5,7
	R60			0,4	1,2	2,6	4,6
	R90			0,4	0,9	2,0	3,4
	R120			0,3	0,8	1,6	2,8
Stainless steel A4, HCR							
Characteristic resistance	R30	$M^0_{Rk,s,fi}$	[Nm]	2,2	5,5	11,2	19,6
	R60			1,5	3,9	8,1	14,3
	R90			0,7	2,2	5,1	8,9
	R120			0,4	1,3	3,5	6,2

Wedge anchor BZ-IG

Performance

Characteristic values for **tension** and **shear loads** under **fire exposure, BZ-IG** cracked and uncracked concrete C20/25 to C50/60

Annex C14

Table C15: Displacements under tension load, BZ-IG

Fastener size			M6	M8	M10	M12
Tension load in cracked concrete	N	[kN]	2,0	3,6	4,8	8,0
	Displacements	δ_{N0}	[mm]	0,6	0,6	0,8
		$\delta_{N\infty}$	[mm]	0,8	0,8	1,2
Tension load in uncracked concrete	N	[kN]	4,8	6,4	8,0	12,0
	Displacements	δ_{N0}	[mm]	0,4	0,5	0,7
		$\delta_{N\infty}$	[mm]	0,8	0,8	1,2

Table C16: Displacements under shear load, BZ-IG

Fastener size			M6	M8	M10	M12
Shear load in cracked and uncracked concrete	V	[kN]	4,2	5,3	6,2	16,9
	Displacements	δ_{V0}	[mm]	2,8	2,9	2,5
		$\delta_{V\infty}$	[mm]	4,2	4,4	3,8

Wedge anchor BZ-IG

Performance
 Displacements under tension load and under shear load **BZ-IG**

Annex C15