

## PROHLÁŠENÍ O VLASTNOSTECH

DoP č. MKT-114 - cz

- ✧ **Jedinečný identifikační kód typu výrobku:** Šroubová kotva BZ plus a BZ-IG
- ✧ **Zamýšlené/zamýšlená použití:** Pevně řízená roztažná kotva pro ukotvení v betonu, viz příloha/Annex B
- ✧ **Výrobce:** MKT Metall-Kunststoff-Technik GmbH & Co.KG  
Auf dem Immel 2  
67685 Weilerbach
- ✧ **System/systémy POSV:** 1
- ✧ **Evropský dokument pro posuzování:** EAD 330232-00-0601  
Evropské technické posouzení: ETA-99/0010, 23.07.2018  
Subjekt pro technické posuzování: DIBt, Berlin  
Oznámený subjekt/oznámené subjekty: NB 1343 – MPA, Darmstadt

✧ **Deklarovaná vlastnost / Deklarované vlastnosti:**

Základní charakteristiky	Vlastnosti
<b>Mechanická odolnost a stabilita (BWR1)</b>	
Charakteristické odpory pro statické a kvazistatické zatížení	BZ plus: Příloha /Annex C1 – C5 BZ-IG: Příloha /Annex C11 – C13
Posuny	BZ plus: Příloha /Annex C9 – C10 BZ-IG: Příloha /Annex C15
Charakteristické odolnosti pro seismické výkonnostní kategorie C1 + C2	BZ plus: Příloha /Annex C6
<b>Požární bezpečnost (BWR2)</b>	
Chování při požáru	Třída A1
Požární odolnost	BZ plus: Příloha /Annex C7 – C8 BZ-IG: Příloha /Annex C14

Vlastností výše uvedeného výrobku jsou ve shodě se souborem deklarovaných vlastností. Toto prohlášení o vlastnostech se v souladu s nařízením (EU) č. 305/2011 vydává na výhradní odpovědnost výrobce uvedeného výše.

Podepsáno za výrobce a jeho jménem:

  
**Stefan Weustenhagen**  
(Výkonný ředitel)  
Weilerbach, 23.07.2018

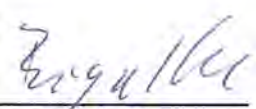
p.p.   
**Dipl.-Ing. Detlef Bigalke**  
(Vedoucí vývoje produktu)



Originál tohoto prohlášení byl napsán v němčině. V případě odchylek v překladu platí německá verze.

## Specifications of intended use

<b>Wedge Anchor BZ plus</b>							
Standard anchorage depth	M8	M10	M12	M16	M20	M24	M27
Steel, galvanized				✓			
Steel, sherardized				✓			
Stainless steel A4 and high corrosion resistant steel HCR			✓				-
Static or quasi-static action				✓			
Fire exposure				✓			
Seismic action (C1 and C2) <sup>1)</sup>			✓			-	-
Reduced anchorage depth <sup>1)</sup>	M8	M10	M12	M16			
Steel, galvanized			✓				
Steel, sherardized			✓				
Stainless steel A4 and high corrosion resistant steel HCR			✓				
Static or quasi-static action			✓				
Fire exposure			✓				
Seismic action (C1 and C2)			-				

<sup>1)</sup> only cold formed anchors acc. to Annex A3

<b>Wedge Anchor BZ-IG</b>				
	M6	M8	M10	M12
Steel, galvanized			✓	
Stainless steel A4 and high corrosion resistant steel HCR			✓	
Static or quasi-static action			✓	
Fire exposure			✓	
Seismic action (C1 and C2)			-	

### Base materials:

- Compacted, reinforced or unreinforced normal weight concrete (without fibers) according to EN 206:2013
- Strength classes C20/25 to C50/60 according to EN 206:2013
- Cracked or uncracked concrete

### Use conditions (Environmental conditions):

- Structures subject to dry internal conditions (steel zinc plated, stainless steel or high corrosion resistant steel).
- Structures subject to external atmospheric exposure including industrial and marine environment or exposure to permanently damp internal condition, if no particular aggressive conditions exist (stainless steel or high corrosion resistant steel).
- Structures subject to external atmospheric exposure and to permanently damp internal condition, if other particular aggressive conditions (high corrosion resistant steel)

Note: Particular aggressive conditions are e.g. permanent, alternating immersion in seawater or the splash zone of seawater, chloride atmosphere of indoor pools or atmosphere with extreme chemical pollution (e.g. in desulphurization plants or road tunnels where de-icing materials are used.)

## Wedge Anchor BZ plus and BZ-IG

Intended use  
Specifications

Annex B1

## Specifications of intended use

### Design:

- Anchorages are designed under the responsibility of an engineer experienced in anchorages and concrete work
- Verifiable calculation notes and drawings are prepared taking account of the loads to be anchored. The position of the fastener is indicated on the design drawings (e.g. position of the fastener relative to reinforcement or to supports, etc.).
- Dimensioning of fasteners under static or quasi-static action, seismic action or fire exposure according to FprEN 1992-4: 2016 in conjunction with TR 055

### Installation:

- Fastener installation carried out by appropriately qualified personnel and under the supervision of the person responsible for technical matters of the site
- Hole drilling by hammer drill bit or vacuum drill bit
- Use of the fastener only as supplied by the manufacturer without exchanging the components of the fastener
- Optionally, the annular gap between fixture and stud of the BZ plus can be filled to reduce the hole. For this purpose, the filling washer (3b) must be used in addition to the supplied washer (3a). For filling use high-strength mortar with compressive strength  $\geq 50\text{N/mm}^2$  (VMZ, VMU plus or VMH)
- In case of aborted hole: new drilling at a minimum distance away of twice the depth of the aborted hole or smaller distance if the aborted drill hole is filled with high strength mortar and if under shear or oblique tension load it is not in the direction of load application

**Wedge Anchor BZ plus and BZ-IG**

**Intended use**  
Specifications

**Annex B2**



**Table B1: Installation parameters, BZ plus**

Fastener size			M8	M10	M12	M16	M20	M24	M27	
Nominal drill hole diameter	$d_0$	[mm]	8	10	12	16	20	24	28	
Cutting diameter of drill bit	$d_{cut} \leq$	[mm]	8,45	10,45	12,5	16,5	20,55	24,55	28,55	
Installation torque	Steel, galvanized	$T_{inst}$	[Nm]	20	25	45	90	160	200	300
	Steel, sherardized	$T_{inst}$	[Nm]	16	22	40	90	160	260	300
	Stainless steel A4, HCR	$T_{inst}$	[Nm]	20	35	50	110	200	290	-
Diameter of clearance hole in the fixture	$d_f \leq$	[mm]	9	12	14	18	22	26	30	
<b>Standard anchorage depth</b>										
Depth of drill hole	Steel, zinc plated	$h_1 \geq$	[mm]	60	75	90	110	125	145	160
	Stainless steel A4, HCR	$h_1 \geq$	[mm]	60	75	90	110	125	155	-
Effective anchorage depth	Steel, zinc plated	$h_{ef}$	[mm]	46	60	70	85	100	115	125
	Stainless steel A4, HCR	$h_{ef}$	[mm]	46	60	70	85	100	125	-
<b>Reduced anchorage depth</b>										
Depth of drill hole	$h_{1,red} \geq$	[mm]	49	55	70	90	-	-	-	
Reduced effective anchorage depth	$h_{ef,red}$	[mm]	35	40	50	65	-	-	-	

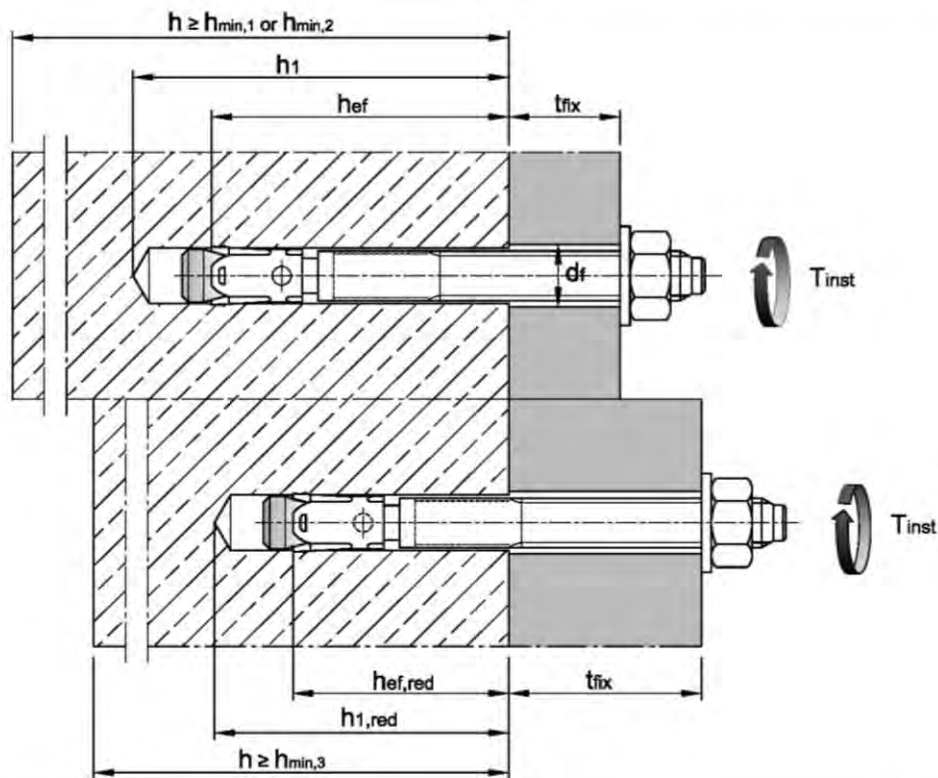

**Wedge anchor BZ plus**

**Intended use**  
Installation parameters

**Annex B3**

**Table B2: Minimum spacings and edge distances, standard anchorage depth, BZ plus**

Fastener size			M8	M10	M12	M16	M20	M24	M27
<b>Standard thickness of concrete member</b>									
<b>Steel zinc plated</b>									
Standard thickness of member	$h_{min,1}$	[mm]	100	120	140	170	200	230	250
<b>Cracked concrete</b>									
Minimum spacing	$S_{min}$	[mm]	40	45	60	60	95	100	125
	für $c \geq$	[mm]	70	70	100	100	150	180	300
Minimum edge distance	$C_{min}$	[mm]	40	45	60	60	95	100	180
	für $s \geq$	[mm]	80	90	140	180	200	220	540
<b>Uncracked concrete</b>									
Minimum spacing	$S_{min}$	[mm]	40	45	60	65	90	100	125
	für $c \geq$	[mm]	80	70	120	120	180	180	300
Minimum edge distance	$C_{min}$	[mm]	50	50	75	80	130	100	180
	für $s \geq$	[mm]	100	100	150	150	240	220	540
<b>Stainless steel A4, HCR</b>									
Standard thickness of member	$h_{min,1}$	[mm]	100	120	140	160	200	250	-
<b>Cracked concrete</b>									
Minimum spacing	$S_{min}$	[mm]	40	50	60	60	95	125	
	für $c \geq$	[mm]	70	75	100	100	150	125	
Minimum edge distance	$C_{min}$	[mm]	40	55	60	60	95	125	
	für $s \geq$	[mm]	80	90	140	180	200	125	
<b>Uncracked concrete</b>									
Minimum spacing	$S_{min}$	[mm]	40	50	60	65	90	125	
	für $c \geq$	[mm]	80	75	120	120	180	125	
Minimum edge distance	$C_{min}$	[mm]	50	60	75	80	130	125	
	für $s \geq$	[mm]	100	120	150	150	240	125	
<b>Minimum thickness of concrete member</b>									
<b>Steel zinc plated, stainless steel A4, HCR</b>									
Minimum thickness of member	$h_{min,2}$	[mm]	80	100	120	140	-	-	-
<b>Cracked concrete</b>									
Minimum spacing	$S_{min}$	[mm]	40	45	60	70			
	für $c \geq$	[mm]	70	90	100	160			
Minimum edge distance	$C_{min}$	[mm]	40	50	60	80			
	für $s \geq$	[mm]	80	115	140	180			
<b>Uncracked concrete</b>									
Minimum spacing	$S_{min}$	[mm]	40	60	60	80			
	für $c \geq$	[mm]	80	140	120	180			
Minimum edge distance	$C_{min}$	[mm]	50	90	75	90			
	für $s \geq$	[mm]	100	140	150	200			
<b>Fire exposure from one side</b>									
Minimum spacing	$S_{min,fi}$	[mm]	See normal ambient temperature						
Minimum edge distance	$C_{min,fi}$	[mm]	See normal ambient temperature						
<b>Fire exposure from more than one side</b>									
Minimum spacing	$S_{min,fi}$	[mm]	See normal ambient temperature						
Minimum edge distance	$C_{min,fi}$	[mm]	$\geq 300$ mm						

Intermediate values by linear interpolation.

**Wedge anchor BZ plus**

**Intended use**  
Minimum spacings and edge distances for standard anchorage depth

**Annex B4**

**Table B3: Minimum spacings and edge distances, reduced anchorage depth, BZ plus**

Fastener size			M8	M10	M12	M16
Minimum thickness of concrete member	$h_{min,s}$	[mm]	80	80	100	140
<b>Cracked concrete</b>						
Minimum spacing	$S_{min}$	[mm]	50	50	50	65
	für $c \geq$	[mm]	60	100	160	170
Minimum edge distance	$C_{min}$	[mm]	40	65	65	100
	für $s \geq$	[mm]	185	180	250	250
<b>Uncracked concrete</b>						
Minimum spacing	$S_{min}$	[mm]	50	50	50	65
	für $c \geq$	[mm]	60	100	160	170
Minimum edge distance	$C_{min}$	[mm]	40	65	100	170
	für $s \geq$	[mm]	185	180	185	65
<b>Fire exposure from one side</b>						
Minimum spacing	$S_{min,fi}$	[mm]	See normal ambient temperature			
Minimum edge distance	$C_{min,fi}$	[mm]	See normal ambient temperature			
<b>Fire exposure from more than one side</b>						
Minimum spacing	$S_{min,fi}$	[mm]	See normal ambient temperature			
Minimum edge distance	$C_{min,fi}$	[mm]	$\geq 300$ mm			



Intermediate values by linear interpolation.

**Wedge anchor BZ plus**

**Intended use**  
Minimum spacings and edge distances for reduced anchorage depth

**Annex B5**

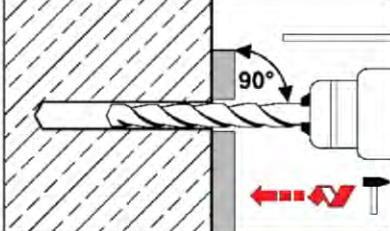
## Installation instructions BZ plus

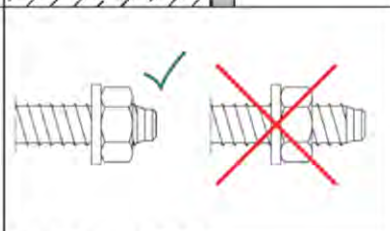
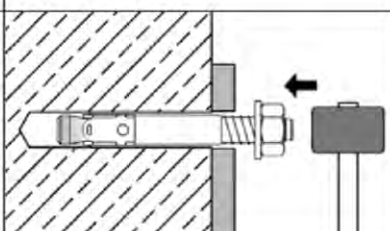
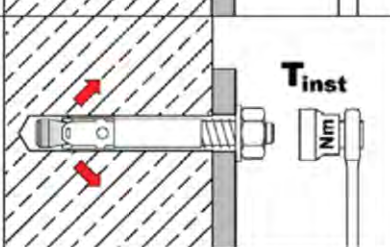
1		<p>Drill hole perpendicular to concrete surface. If using a vacuum drill bit, proceed with step 3.</p>
2		<p>Blow out dust. Alternatively vacuum clean down to the bottom of the hole.</p>
3		<p>Check position of nut.</p>
4		<p>Drive in fastener, such that <math>h_{ef}</math> or <math>h_{ef,red}</math> depth is met. This compliance is ensured, if the thickness of fixture is not greater than the maximum thickness of fixture marked on the fastener in accordance with Annex A3.</p>
5		<p>Installation torque <math>T_{inst}</math> shall be applied by using calibrated torque wrench.</p>

### Wedge anchor BZ plus

**Intended Use**  
Installation instructions

**Annex B6**

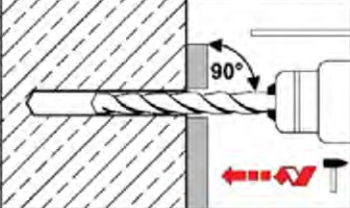
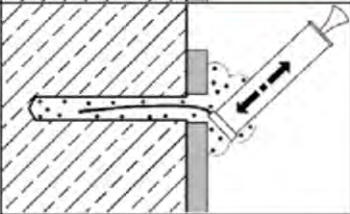
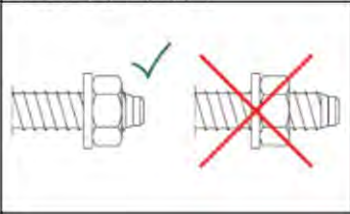
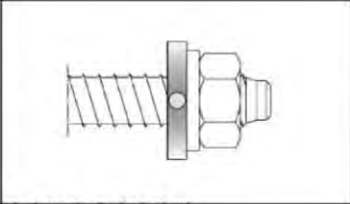
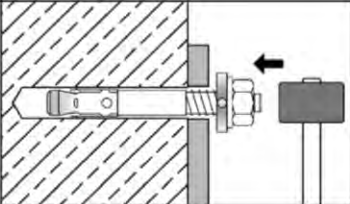
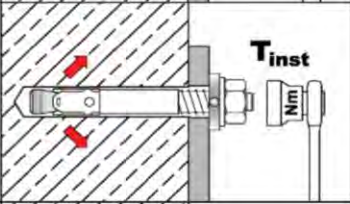
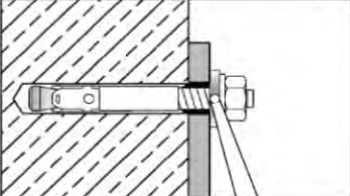

## Installation instructions BZ plus with filling of annular gap

1		<p>Drill hole perpendicular to concrete surface. If using a vacuum drill bit, proceed with step 3a.</p>
2		<p>Blow out dust. Alternatively vacuum clean down to the bottom of the hole.</p>
3a		<p>Check position of nut.</p>
3b		<p>Fit the filling washer to the fastener. The thickness of the filling washer must be taken into account with <math>t_{fix}</math>.</p>
4		<p>Drive in fastener with filling washer, such that <math>h_{ef}</math> or <math>h_{ef,red}</math> depth is met. This compliance is ensured, if the thickness of fixture is 5mm smaller than the maximum thickness of fixture marked on the fastener in accordance with Annex A3.</p>
5		<p>Installation torque <math>T_{inst}</math> shall be applied by using calibrated torque wrench.</p>
6		<p>Fill the annular gap between stud and fixture with mortar (compressive strength <math>\geq 50 \text{ N/mm}^2</math> VMH, VMZ or VMU plus). Use enclosed reducing adapter. Observe the processing information of the mortar! The annular gap is completely filled, when excess mortar seeps out.</p>

### Wedge anchor BZ plus

**Intended Use**  
Installation instructions with filling washer

**Annex B7**



**Table B4: Installation parameters BZ-IG**

Fastener size			M6	M8	M10	M12
Effective anchorage depth	$h_{ef}$	[mm]	45	58	65	80
Drill hole diameter	$d_0$	[mm]	8	10	12	16
Cutting diameter of drill bit	$d_{cut} \leq$	[mm]	8,45	10,45	12,5	16,5
Depth of drill hole	$h_1 \geq$	[mm]	60	75	90	105
Screwing depth of threaded rod	$L_{sd}^{2)} \geq$	[mm]	9	12	15	18
Installation torque, steel zinc plated	$T_{inst}$	S [Nm]	10	30	30	55
		SK [Nm]	10	25	40	50
		B [Nm]	8	25	30	45
Installation torque, stainless steel A4, HCR	$T_{inst}$	S [Nm]	15	40	50	100
		SK [Nm]	12	25	45	60
		B [Nm]	8	25	40	80
<b>Pre-setting installation</b>						
Diameter of clearance hole in the fixture	$d_f \leq$	[mm]	7	9	12	14
Minimum thickness of fixture	$t_{fix} \geq$	S [mm]	1	1	1	1
		SK [mm]	5	7	8	9
		B [mm]	1	1	1	1
<b>Through-setting installation</b>						
Diameter of clearance hole in the fixture	$d_f \leq$	[mm]	9	12	14	18
Minimum thickness of fixture <sup>1)</sup>	$t_{fix} \geq$	S [mm]	5	7	8	9
		SK [mm]	9	12	14	16
		B [mm]	5	7	8	9

<sup>1)</sup> The minimum thickness of fixture can be reduced to the value of Pre-setting installation, if the shear load at steel failure is designed with lever arm.

<sup>2)</sup> see Annex A5

**Table B5: Minimum spacings and edge distances BZ-IG**

Fastener size			M6	M8	M10	M12
Minimum thickness of concrete member	$h_{min}$	[mm]	100	120	130	160
<b>Cracked concrete</b>						
Minimum spacing	$s_{min}$	[mm]	50	60	70	80
	für $c \geq$	[mm]	60	80	100	120
Minimum edge distance	$c_{min}$	[mm]	50	60	70	80
	für $s \geq$	[mm]	75	100	100	120
<b>Uncracked concrete</b>						
Minimum spacing	$s_{min}$	[mm]	50	60	65	80
	für $c \geq$	[mm]	80	100	120	160
Minimum edge distance	$c_{min}$	[mm]	50	60	70	100
	für $s \geq$	[mm]	115	155	170	210
<b>Fire exposure from one side</b>						
Minimum spacing	$s_{min,fi}$	[mm]	See normal temperature			
Minimum edge distance	$c_{min,fi}$	[mm]	See normal temperature			
<b>Fire exposure from more than one side</b>						
Minimum spacing	$s_{min,fi}$	[mm]	See normal temperature			
Minimum edge distance	$c_{min,fi}$	[mm]	$\geq 300$ mm			

Intermediate values by linear interpolation.

**Wedge anchor BZ-IG****Intended use**

Installation parameters, minimum spacings and edge distances **BZ-IG**

**Annex B8**

## Installation instructions **BZ-IG**

### Pre-setting installation

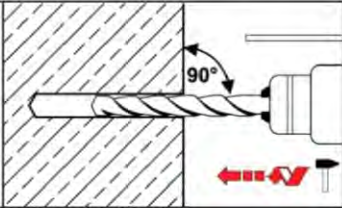
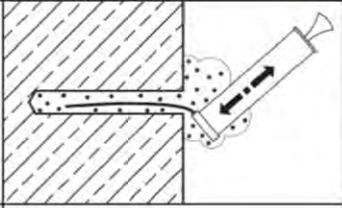
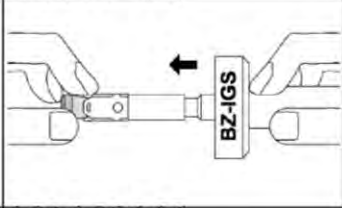
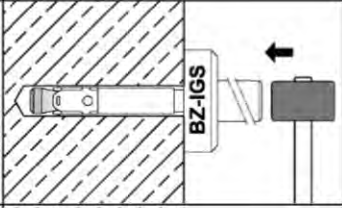
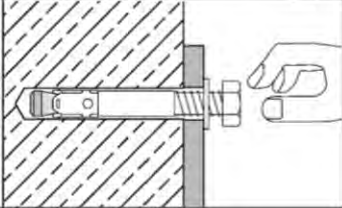
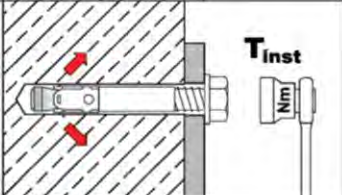
1		Drill hole perpendicular to concrete surface. If using vacuum drill bit, proceed with step 3.
2		Blow out dust. Alternatively vacuum clean down to the bottom of the hole.
3		Setting tool for <b>pre-setting installation</b> insert in fastener.
4		Drive in fastener with setting tool.
5		Drive in screw.
6		Installation torque $T_{inst}$ may be applied by using calibrated torque wrench.

### Wedge anchor **BZ-IG**



#### Intended Use

Installation instructions for pre-setting installation **BZ-IG**

Annex B9

## Installation instructions **BZ-IG**

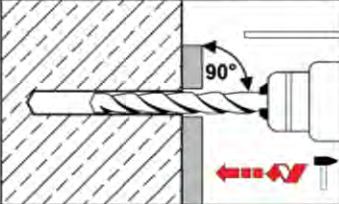
### Through-setting installation

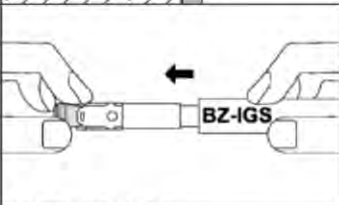
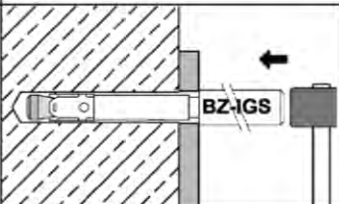
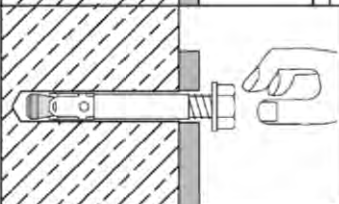
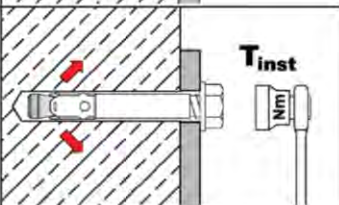
1		Drill hole perpendicular to concrete surface. If using a vacuum drill bit, proceed with step 3.
2		Blow out dust. Alternatively vacuum clean down to the bottom of the hole.
3		Setting tool for <b>through-setting installation</b> insert in fastener.
4		Drive in fastener with setting tool.
5		Drive in screw.
6		Installation torque $T_{inst}$ may be applied by using calibrated torque wrench.

### Wedge anchor **BZ-IG**

#### Intended Use

Installation instructions for through-setting installation **BZ-IG**

Annex B10



**Table C1: Characteristic values for tension loads, BZ plus zinc plated, cracked concrete, static and quasi-static action**

Fastener size		M8	M10	M12	M16	M20	M24	M27
Installation factor	$\gamma_{inst}$ [-]	1,0						
<b>Steel failure</b>								
Characteristic resistance	$N_{Rk,s}$ [kN]	16	27	40	60	86	126	196
Partial factor	$\gamma_{Ms}$ [-]	1,53		1,5		1,6	1,5	
<b>Pull-out</b>								
<b>Standard anchorage depth</b>								
Characteristic resistance in cracked concrete C20/25	$N_{Rk,p}$ [kN]	5	9	16	25	1)	1)	1)
<b>Reduced anchorage depth</b>								
Characteristic resistance in cracked concrete C20/25	$N_{Rk,p}$ [kN]	5	7,5	1)	1)	-	-	-
Increasing factor for $N_{Rk,p}$	$\psi_C$ [-]	$\left(\frac{f_{ck}}{20}\right)^{0,5}$						
<b>Concrete cone failure</b>								
Effective anchorage depth	$h_{ef}$ [mm]	46	60	70	85	100	115	125
Reduced anchorage depth	$h_{ef,red}$ [mm]	35 <sup>2)</sup>	40	50	65	-	-	-
Factor for cracked concrete	$k_1 = k_{Cr,N}$ [-]	7,7						

1) Pull-out is not decisive

2) Use restricted to anchoring of structural components statically indeterminate

**Wedge anchor BZ plus**

**Performance**

Characteristic values for **tension loads, BZ plus zinc plated, cracked concrete**, static and quasi-static action

**Annex C1**

**Table C2: Characteristic values for tension loads, BZ plus A4 / HCR, cracked concrete, static and quasi-static action**

Fastener size		M8	M10	M12	M16	M20	M24
Installation factor	$\gamma_{inst}$ [-]	1,0					
<b>Steel failure</b>							
Characteristic resistance	$N_{Rk,s}$ [kN]	16	27	40	64	108	110
Partial factor	$\gamma_{Ms}$ [-]	1,5				1,68	1,5
<b>Pull-out</b>							
<b>Standard anchorage depth</b>							
Characteristic resistance in cracked concrete C20/25	$N_{Rk,p}$ [kN]	5	9	16	25	1) <sup>1)</sup>	40
<b>Reduced anchorage depth</b>							
Characteristic resistance in cracked concrete C20/25	$N_{Rk,p}$ [kN]	5	7,5	1) <sup>1)</sup>	1) <sup>1)</sup>	-	-
Increasing factor for $N_{Rk,p}$	$\psi_c$ [-]	$\left(\frac{f_{ck}}{20}\right)^{0,5}$					
<b>Concrete cone failure</b>							
Effective anchorage depth	$h_{ef}$ [mm]	46	60	70	85	100	125
Reduced anchorage depth	$h_{ef,red}$ [mm]	35 <sup>2)</sup>	40	50	65	-	-
Factor for cracked concrete	$k_1 = k_{cr,N}$ [-]	7,7					

<sup>1)</sup> Pull-out is not decisive

<sup>2)</sup> Use restricted to anchoring of structural components statically indeterminate

**Wedge anchor BZ plus**

**Performance**

Characteristic values for **tension loads, BZ plus A4 / HCR, cracked concrete**, static and quasi-static action

**Annex C2**

**Table C3: Characteristic values for tension loads, BZ plus zinc plated, uncracked concrete, static and quasi-static action**

Fastener size		M8	M10	M12	M16	M20	M24	M27
Installation factor	$\gamma_{inst}$ [-]	1,0						
<b>Steel failure</b>								
Characteristic resistance	$N_{Rk,s}$ [kN]	16	27	40	60	86	126	196
Partial factor	$\gamma_{Ms}$ [-]	1,53		1,5		1,6	1,5	
<b>Pull-out</b>								
<b>Standard anchorage depth</b>								
Characteristic resistance in uncracked concrete C20/25	$N_{Rk,p}$ [kN]	12	16	25	35	1) <sup>1)</sup>	1) <sup>1)</sup>	1) <sup>1)</sup>
<b>Reduced anchorage depth</b>								
Characteristic resistance in uncracked concrete C20/25	$N_{Rk,p}$ [kN]	7,5	9	1) <sup>1)</sup>	1) <sup>1)</sup>	-	-	-
<b>Splitting</b>								
<b>Standard anchorage depth</b>								
Splitting for <b>standard thickness of concrete member</b> (The higher resistance of case 1 and case 2 may be applied; $C_{cr,sp}$ may be linearly interpolated for the member thickness $h_{min,2} < h < h_{min,1}$ (Case 2); $\psi_{h,sp} = 1,0$ )								
Standard thickness of concrete	$h_{min,1} \geq$ [mm]	100	120	140	170	200	230	250
<b>Case 1</b>								
Characteristic resistance in uncracked concrete C20/25	$N^0_{Rk,sp}$ [kN]	9	12	20	30	40	62,3	50
Edge distance	$C_{cr,sp}$ [mm]	1,5 $h_{ef}$						
<b>Case 2</b>								
Characteristic resistance in uncracked concrete C20/25	$N^0_{Rk,sp}$ [kN]	12	16	25	35	50,5	62,3	70,6
Edge distance	$C_{cr,sp}$ [mm]	2 $h_{ef}$				2,2 $h_{ef}$	1,5 $h_{ef}$	2,5 $h_{ef}$
<b>Splitting for minimum thickness of concrete member</b>								
Minimum thickness of concrete	$h_{min,2} \geq$ [mm]	80	100	120	140			
Characteristic resistance in uncracked concrete C20/25	$N^0_{Rk,sp}$ [kN]	12	16	25	35	-	-	-
Edge distance	$C_{cr,sp}$ [mm]	2,5 $h_{ef}$						
<b>Reduced anchorage depth</b>								
Minimum thickness of concrete	$h_{min,3} \geq$ [mm]	80	80	100	140			
Characteristic resistance in uncracked concrete C20/25	$N^0_{Rk,sp}$ [kN]	7,5	9	17,9	26,5	-	-	-
Edge distance	$C_{cr,sp}$ [mm]	100	100	125	150			
Increasing factor for $N_{Rk,p}$ and $N^0_{Rk,sp}$	$\psi^c$ [-]	$\left(\frac{f_{ck}}{20}\right)^{0,5}$						
<b>Concrete cone failure</b>								
Effective anchorage depth	$h_{ef}$ [mm]	46	60	70	85	100	115	125
Reduced anchorage depth	$h_{ef,red}$ [mm]	35 <sup>2)</sup>	40	50	65	-	-	-
Factor for uncracked concrete	$k_1 = k_{Ucr,N}$ [-]	11,0						

<sup>1)</sup> Pull-out is not decisive

<sup>2)</sup> Use restricted to anchoring of structural components statically indeterminate

### Wedge anchor BZ plus

#### Performance

Characteristic values for **tension loads, BZ plus zinc plated, uncracked concrete**, static and quasi-static action

**Annex C3**



**Table C4:** Characteristic values for **tension loads, BZ plus A4 / HCR, uncracked concrete**, static and quasi-static action

Fastener size			M8	M10	M12	M16	M20	M24
Installation factor	$\gamma_{inst}$	[-]	1,0					
<b>Steel failure</b>								
Characteristic resistance	$N_{Rk,s}$	[kN]	16	27	40	64	108	110
Partial factor	$\gamma_{Ms}$	[-]	1,5				1,68	1,5
<b>Pull-out</b>								
<b>Standard anchorage depth</b>								
Characteristic resistance in uncracked concrete C20/25	$N_{Rk,p}$	[kN]	12	16	25	35	1)	1)
<b>Reduced anchorage depth</b>								
Characteristic resistance in uncracked concrete C20/25	$N_{Rk,p}$	[kN]	7,5	9	1)	1)	-	-
<b>Splitting</b>								
<b>Standard anchorage depth</b>								
Splitting for <b>standard thickness of concrete member</b> (The higher resistance of case 1 and case 2 may be applied; $C_{cr,sp}$ may be linearly interpolated for the member thickness $h_{min,2} < h < h_{min,1}$ (Case 2); $\psi_{h,sp} = 1,0$ )								
Standard thickness of concrete	$h_{min,1} \geq$	[mm]	100	120	140	160	200	250
<b>Case 1</b>								
Characteristic resistance in uncracked concrete C20/25	$N^0_{Rk,sp}$	[kN]	9	12	20	30	40	-
Edge distance	$C_{cr,sp}$	[mm]	1,5 $h_{ef}$					
<b>Case 2</b>								
Characteristic resistance in uncracked concrete C20/25	$N^0_{Rk,sp}$	[kN]	12	16	25	35	50,5	70,6
Edge distance	$C_{cr,sp}$	[mm]	115	125	140	200	220	250
<b>Splitting for minimum thickness of concrete member</b>								
Minimum thickness of concrete	$h_{min,2} \geq$	[mm]	80	100	120	140		
Characteristic resistance in uncracked concrete C20/25	$N^0_{Rk,sp}$	[kN]	12	16	25	35	-	-
Edge distance	$C_{cr,sp}$	[mm]	2,5 $h_{ef}$					
<b>Reduced anchorage depth</b>								
Minimum thickness of concrete	$h_{min,3} \geq$	[mm]	80	80	100	140		
Characteristic resistance in uncracked concrete C20/25	$N^0_{Rk,sp}$	[kN]	7,5	9	17,9	26,5	-	-
Edge distance	$C_{cr,sp}$	[mm]	100	100	125	150		
Increasing factor for $N_{Rk,p}$ and $N^0_{Rk,sp}$	$\psi_c$	[-]	$\left(\frac{f_{ck}}{20}\right)^{0,5}$					
<b>Concrete cone failure</b>								
Effective anchorage depth	$h_{ef}$	[mm]	46	60	70	85	100	125
Reduced anchorage depth	$h_{ef,red}$	[mm]	35 <sup>2)</sup>	40	50	65	-	-
Factor for uncracked concrete	$k_1 = k_{ucr,N}$	[-]	11,0					

1) Pull-out is not decisive

2) Use restricted to anchoring of structural components statically indeterminate

**Wedge anchor BZ plus**

**Performance**

Characteristic values for **tension loads, BZ plus A4 / HCR, uncracked concrete**, static and quasi-static action

**Annex C4**

**Table C5:** Characteristic values for **shear loads, BZ plus, cracked and uncracked concrete**, static or quasi static action

Fastener size			M8	M10	M12	M16	M20	M24	M27	
Installation factor	$\gamma_{inst}$	[-]	1,0							
<b>Steel failure without lever arm, Steel zinc plated</b>										
Characteristic resistance	$V^0_{Rk,s}$	[kN]	12,2	20,1	30	55	69	114	169,4	
Ductility factor	$k_7$	[-]	1,0							
Partial factor	$\gamma_{Ms}$	[-]	1,25				1,33	1,25	1,25	
<b>Steel failure without lever arm, Stainless steel A4, HCR</b>										
Characteristic resistance	$V^0_{Rk,s}$	[kN]	13	20	30	55	86	123,6	-	
Ductility factor	$k_7$	[-]	1,0							
Partial factor	$\gamma_{Ms}$	[-]	1,25				1,4	1,25		
<b>Steel failure with lever arm, Steel zinc plated</b>										
Characteristic bending resistance	$M^0_{Rk,s}$	[Nm]	23	47	82	216	363	898	1331,5	
Partial factor	$\gamma_{Ms}$	[-]	1,25				1,33	1,25	1,25	
<b>Steel failure with lever arm, Stainless steel A4, HCR</b>										
Characteristic bending resistance	$M^0_{Rk,s}$	[Nm]	26	52	92	200	454	785,4	-	
Partial factor	$\gamma_{Ms}$	[-]	1,25				1,4	1,25		
<b>Concrete pry-out failure</b>										
Pry-out factor	$k_8$	[-]	2,4				2,8			
<b>Concrete edge failure</b>										
Effective length of fastener in shear loading with $h_{ef}$	Steel zinc plated	$l_f$	[mm]	46	60	70	85	100	115	125
	Stainless steel A4, HCR	$l_f$	[mm]	46	60	70	85	100	125	-
Effective length of fastener in shear loading with $h_{ef,red}$	Steel zinc plated	$l_{f,red}$	[mm]	35 <sup>1)</sup>	40	50	65	-	-	-
	Stainless steel A4, HCR	$l_{f,red}$	[mm]	35 <sup>1)</sup>	40	50	65			
Outside diameter of fastener	$d_{nom}$	[mm]	8	10	12	16	20	24	27	

<sup>1)</sup> Use restricted to anchoring of structural components statically indeterminate

**Wedge anchor BZ plus**

**Performance**

Characteristic values for **shear loads, BZ plus, cracked and uncracked concrete**, static or quasi static action

**Annex C5**

**Table C6:** Characteristic resistance for **seismic loading**, BZ plus,  
**standard anchorage depth**, performance category **C1** and **C2**

Fastener size			M8	M10	M12	M16	M20
<b>Tension loads</b>							
Installation factor	$\gamma_{inst}$	[-]	1,0				
<b>Steel failure, Steel zinc plated</b>							
Characteristic resistance <b>C1</b>	$N_{Rk,s,eq,C1}$	[kN]	16	27	40	60	86
Characteristic resistance <b>C2</b>	$N_{Rk,s,eq,C2}$	[kN]	16	27	40	60	86
Partial factor	$\gamma_{Ms}$	[-]	1,53		1,5		1,6
<b>Steel failure, Stainless steel A4, HCR</b>							
Characteristic resistance <b>C1</b>	$N_{Rk,s,eq,C1}$	[kN]	16	27	40	64	108
Characteristic resistance <b>C2</b>	$N_{Rk,s,eq,C2}$	[kN]	16	27	40	64	108
Partial factor	$\gamma_{Ms}$	[-]	1,5				1,68
<b>Pull-out (steel zinc plated, stainless steel A4 and HCR)</b>							
Characteristic resistance <b>C1</b>	$N_{Rk,p,eq,C1}$	[kN]	5	9	16	25	36
Characteristic resistance <b>C2</b>	$N_{Rk,p,eq,C2}$	[kN]	2,3	3,6	10,2	13,8	24,4
<b>Shear loads</b>							
<b>Steel failure without lever arm, Steel zinc plated</b>							
Characteristic resistance <b>C1</b>	$V_{Rk,s,eq,C1}$	[kN]	9,3	20	27	44	69
Characteristic resistance <b>C2</b>	$V_{Rk,s,eq,C2}$	[kN]	6,7	14	16,2	35,7	55,2
Partial factor	$\gamma_{Ms}$	[-]	1,25				1,33
<b>Steel failure without lever arm, Stainless steel A4, HCR</b>							
Characteristic resistance <b>C1</b>	$V_{Rk,s,eq,C1}$	[kN]	9,3	20	27	44	69
Characteristic resistance <b>C2</b>	$V_{Rk,s,eq,C2}$	[kN]	6,7	14	16,2	35,7	55,2
Partial factor	$\gamma_{Ms}$	[-]	1,25				1,4
Factor for annular gap	<b>without</b> filling of annular gap	$\alpha_{gap}$	[-]	0,5			
	<b>with</b> filling of annular gap	$\alpha_{gap}$	[-]	1,0			

**Wedge anchor BZ plus**

**Performance**

Characteristic resistance for **seismic loading**, BZ plus,  
**standard anchorage depth**, performance category **C1** and **C2**

**Annex C6**



**Table C7: Characteristic values for tension and shear load under fire exposure, BZ plus, standard anchorage depth, cracked and uncracked concrete C20/25 to C50/60**

Fastener size		M8	M10	M12	M16	M20	M24	M27		
<b>Tension load</b>										
<b>Steel failure</b>										
<b>Steel, zinc plated</b>										
Characteristic resistance	R30	$N_{Rk,s,fi}$	[kN]	1,5	2,6	4,1	7,7	9,4	13,6	17,6
	R60			1,1	1,9	3,0	5,6	8,2	11,8	15,3
	R90			0,8	1,4	2,4	4,4	6,9	10,0	13,0
	R120			0,7	1,2	2,2	4,0	6,3	9,1	11,8
<b>Stainless steel A4, HCR</b>										
Characteristic resistance	R30	$N_{Rk,s,fi}$	[kN]	3,8	6,9	12,7	23,7	33,5	48,2	
	R60			2,9	5,3	9,4	17,6	25,0	35,9	
	R90			2,0	3,6	6,1	11,5	16,4	23,6	
	R120			1,6	2,8	4,5	8,4	12,1	17,4	
<b>Shear load</b>										
<b>Steel failure without lever arm</b>										
<b>Steel, zinc plated</b>										
Characteristic resistance	R30	$V_{Rk,s,fi}$	[kN]	1,6	2,6	4,1	7,7	11	16	20,6
	R60			1,5	2,5	3,6	6,8	11	15	19,8
	R90			1,2	2,1	3,5	6,5	10	15	19,0
	R120			1,0	2,0	3,4	6,4	10	14	18,6
<b>Stainless steel A4, HCR</b>										
Characteristic resistance	R30	$V_{Rk,s,fi}$	[kN]	3,8	6,9	12,7	23,7	33,5	48,2	
	R60			2,9	5,3	9,4	17,6	25,0	35,9	
	R90			2,0	3,6	6,1	11,5	16,4	23,6	
	R120			1,6	2,8	4,5	8,4	12,1	17,4	
<b>Steel failure with lever arm</b>										
<b>Steel, zinc plated</b>										
Characteristic resistance	R30	$M^0_{Rk,s,fi}$	[Nm]	1,7	3,3	6,4	16,3	29	50	75
	R60			1,6	3,2	5,6	14	28	48	72
	R90			1,2	2,7	5,4	14	27	47	69
	R120			1,1	2,5	5,3	13	26	46	68
<b>Stainless steel A4, HCR</b>										
Characteristic resistance	R30	$M^0_{Rk,s,fi}$	[Nm]	3,8	9,0	19,7	50,1	88,8	153,5	
	R60			2,9	6,8	14,6	37,2	66,1	114,3	
	R90			2,1	4,7	9,5	24,2	43,4	75,1	
	R120			1,6	3,6	7,0	17,8	32,1	55,5	

If pull-out is not decisive,  $N_{Rk,p}$  must be replaced by  $N^0_{Rk,c}$  in equation (D.4) and (D.5), FprEN 1992-4.

### Wedge anchor BZ plus

#### Performance

Characteristic values for tension and shear load under fire exposure, BZ plus, standard anchorage depth, cracked and uncracked concrete C20/25 to C50/60

**Annex C7**

**Table C8: Characteristic values for tension and shear load under fire exposure, BZ plus, reduced anchorage depth, cracked and uncracked concrete C20/25 to C50/60**

Fastener size		M8	M10	M12	M16		
<b>Tension load</b>							
<b>Steel failure</b>							
<b>Steel, zinc plated</b>							
Characteristic resistance	R30	$N_{Rk,s,fi}$	[kN]	1,5	2,6	4,1	7,7
	R60			1,1	1,9	3,0	5,6
	R90			0,8	1,3	1,9	3,5
	R120			0,6	1,0	1,3	2,5
<b>Stainless steel A4, HCR</b>							
Characteristic resistance	R30	$N_{Rk,s,fi}$	[kN]	3,2	6,9	12,7	23,7
	R60			2,5	5,3	9,4	17,6
	R90			1,9	3,6	6,1	11,5
	R120			1,6	2,8	4,5	8,4
<b>Shear load</b>							
<b>Steel failure without lever arm</b>							
<b>Steel, zinc plated</b>							
Characteristic resistance	R30	$V_{Rk,s,fi}$	[kN]	1,5	2,6	4,1	7,7
	R60			1,1	1,9	3,0	5,6
	R90			0,8	1,3	1,9	3,5
	R120			0,6	1,0	1,3	2,5
<b>Stainless steel A4, HCR</b>							
Characteristic resistance	R30	$V_{Rk,s,fi}$	[kN]	3,2	6,9	12,7	23,7
	R60			2,5	5,3	9,4	17,6
	R90			1,9	3,6	6,1	11,5
	R120			1,6	2,8	4,5	8,4
<b>Steel failure with lever arm</b>							
<b>Steel, zinc plated</b>							
Characteristic resistance	R30	$M^0_{Rk,s,fi}$	[Nm]	1,5	3,3	6,4	16,3
	R60			1,2	2,5	4,7	11,9
	R90			0,8	1,7	3,0	7,5
	R120			0,6	1,2	2,1	5,3
<b>Stainless steel A4, HCR</b>							
Characteristic resistance	R30	$M^0_{Rk,s,fi}$	[Nm]	3,2	8,9	19,7	50,1
	R60			2,6	6,8	14,6	37,2
	R90			2,0	4,7	9,5	24,2
	R120			1,6	3,6	7,0	17,8

If pull-out is not decisive,  $N_{Rk,p}$  must be replaced by  $N^0_{Rk,c}$  in equation (D.4) and (D.5), FprEN 1992-4.

**Wedge anchor BZ plus**

**Performance**

Characteristic values for tension and shear load under fire exposure, BZ plus, reduced anchorage depth, cracked and uncracked concrete C20/25 to C50/60

**Annex C8**

**Table C9: Displacements under tension load, BZ plus**

Fastener size			M8	M10	M12	M16	M20	M24	M27
<b>Standard anchorage depth</b>									
<b>Steel zinc plated</b>									
Tension load in cracked concrete	N	[kN]	2,4	4,3	7,6	11,9	17,1	21,1	24
Displacement	$\delta_{N0}$	[mm]	0,6	1,0	0,4	1,0	0,9	0,7	0,9
	$\delta_{N\infty}$	[mm]	1,4	1,2	1,4	1,3	1,0	1,2	1,4
Tension load in uncracked concrete	N	[kN]	5,7	7,6	11,9	16,7	23,8	29,6	34
Displacement	$\delta_{N0}$	[mm]	0,4	0,5	0,7	0,3	0,4	0,5	0,3
	$\delta_{N\infty}$	[mm]	0,8		1,4	0,8		1,4	
<b>Displacements under seismic tension loads C2</b>									
Displacements for DLS	$\delta_{N,eq,(DLS)}$	[mm]	2,3	4,1	4,9	3,6	5,1	-	-
Displacements for ULS	$\delta_{N,eq,(ULS)}$	[mm]	8,2	13,8	15,7	9,5	15,2	-	-
<b>Stainless steel A4, HCR</b>									
Tension load in cracked concrete	N	[kN]	2,4	4,3	7,6	11,9	17,1	19,0	-
Displacement	$\delta_{N0}$	[mm]	0,7	1,8	0,4	0,7	0,9	0,5	
	$\delta_{N\infty}$	[mm]	1,2	1,4	1,4	1,4	1,0	1,8	
Tension load in uncracked concrete	N	[kN]	5,8	7,6	11,9	16,7	23,8	33,5	-
Displacement	$\delta_{N0}$	[mm]	0,6	0,5	0,7	0,2	0,4	0,5	
	$\delta_{N\infty}$	[mm]	1,2	1,0	1,4	0,4	0,8	1,1	
<b>Displacements under seismic tension loads C2</b>									
Displacements for DLS	$\delta_{N,eq,(DLS)}$	[mm]	2,3	4,1	4,9	3,6	5,1	-	-
Displacements for ULS	$\delta_{N,eq,(ULS)}$	[mm]	8,2	13,8	15,7	9,5	15,2	-	-
<b>Reduced anchorage depth</b>									
<b>Steel zinc plated, stainless steel A4, HCR</b>									
Tension load in cracked concrete	N	[kN]	2,4	3,6	6,1	9,0	-	-	-
Displacement	$\delta_{N0}$	[mm]	0,8	0,7	0,5	1,0			
	$\delta_{N\infty}$	[mm]	1,2	1,0	0,8	1,1			
Tension load in uncracked concrete	N	[kN]	3,7	4,3	8,5	12,6	-	-	-
Displacement	$\delta_{N0}$	[mm]	0,1	0,2	0,2	0,2			
	$\delta_{N\infty}$	[mm]	0,7	0,7	0,7	0,7			

**Wedge anchor BZ plus**
**Performance**  
 Displacements under tension load

**Annex C9**

**Table C10: Displacements under shear load, BZ plus**

Fastener size			M8	M10	M12	M16	M20	M24	M27
<b>Standard anchorage depth</b>									
<b>Steel zinc plated</b>									
Shear load in cracked and uncracked concrete	V	[kN]	6,9	11,4	17,1	31,4	36,8	64,9	96,8
Displacement	$\delta_{V0}$	[mm]	2,0	3,2	3,6	3,5	1,8	3,5	3,6
	$\delta_{V\infty}$	[mm]	3,0	4,7	5,5	5,3	2,7	5,3	5,4
<b>Displacements under seismic shear loads C2</b>									
Displacements for DLS	$\delta_{V,eq(DLS)}$	[mm]	3,0	2,7	3,5	4,3	4,7	-	-
Displacements for ULS	$\delta_{V,eq(ULS)}$	[mm]	5,9	5,3	9,5	9,6	10,1	-	-
<b>Stainless steel A4, HCR</b>									
Shear load in cracked and uncracked concrete	V	[kN]	7,3	11,4	17,1	31,4	43,8	70,6	-
Displacement	$\delta_{V0}$	[mm]	1,9	2,4	4,0	4,3	2,9	2,8	-
	$\delta_{V\infty}$	[mm]	2,9	3,6	5,9	6,4	4,3	4,2	-
<b>Displacements under seismic shear loads C2</b>									
Displacements for DLS	$\delta_{V,eq(DLS)}$	[mm]	3,0	2,7	3,5	4,3	4,7	-	-
Displacements for ULS	$\delta_{V,eq(ULS)}$	[mm]	5,9	5,3	9,5	9,6	10,1	-	-
<b>Reduced anchorage depth</b>									
<b>Steel zinc plated</b>									
Shear load in cracked and uncracked concrete	V	[kN]	6,9	11,4	17,1	31,4	-	-	-
Displacement	$\delta_{V0}$	[mm]	2,0	3,2	3,6	3,5	-	-	-
	$\delta_{V\infty}$	[mm]	3,0	4,7	5,5	5,3	-	-	-
<b>Stainless steel A4, HCR</b>									
Shear load in cracked and uncracked concrete	V	[kN]	7,3	11,4	17,1	31,4	-	-	-
Displacement	$\delta_{V0}$	[mm]	1,9	2,4	4,0	4,3	-	-	-
	$\delta_{V\infty}$	[mm]	2,9	3,6	5,9	6,4	-	-	-

**Wedge anchor BZ plus**

**Performance**  
Displacements under shear load

**Annex C10**



**Table C11:** Characteristic values for **tension loads, BZ-IG, cracked concrete**, static and quasi-static action

Fastener size			M6	M8	M10	M12
Installation factor	$\gamma_{inst}$	[-]	1,2			
<b>Steel failure</b>						
Characteristic resistance, steel zinc plated	$N_{Rk,s}$	[kN]	16,1	22,6	26,0	56,6
Partial factor	$\gamma_{Ms}$	[-]	1,5			
Characteristic resistance, stainless steel A4, HCR	$N_{Rk,s}$	[kN]	14,1	25,6	35,8	59,0
	$\gamma_{Ms}$	[-]	1,87			
<b>Pull-out failure</b>						
Characteristic resistance in cracked concrete C20/25	$N_{Rk,p}$	[kN]	5	9	12	20
Increasing factor for $N_{Rk,p}$	$\psi_c$	[-]	$\left(\frac{f_{ck}}{20}\right)^{0,5}$			
<b>Concrete cone failure</b>						
Effective anchorage depth	$h_{ef}$	[mm]	45	58	65	80
Factor for cracked concrete	$k_1 = k_{cr,N}$	[-]	7,7			

**Wedge anchor BZ-IG**

**Performance**

Characteristic values for **tension loads, BZ-IG, cracked concrete**, static and quasi-static action

**Annex C11**

**Table C12: Characteristic values for tension loads, BZ-IG, uncracked concrete, static and quasi-static action**

Fastener size			M6	M8	M10	M12
Installation factor	$\gamma_{inst}$	[-]	1,2			
<b>Steel failure</b>						
Characteristic resistance, steel zinc plated	$N_{Rk,s}$	[kN]	16,1	22,6	26,0	56,6
Partial factor	$\gamma_{Ms}$	[-]	1,5			
Characteristic resistance, stainless steel A4, HCR	$N_{Rk,s}$	[kN]	14,1	25,6	35,8	59,0
Partial factor	$\gamma_{Ms}$	[-]	1,87			
<b>Pull-out</b>						
Characteristic resistance in uncracked concrete C20/25	$N_{Rk,p}$	[kN]	12	16	20	30
<b>Splitting</b> (the higher resistance of Case 1 and Case 2 may be applied)						
Minimum thickness of concrete member	$h_{min}$	[mm]	100	120	130	160
<b>Case 1</b>						
Characteristic resistance in uncracked concrete C20/25	$N^0_{Rk,sp}$	[kN]	9	12	16	25
Edge distance	$c_{Cr,sp}$	[mm]	1,5 $h_{ef}$			
<b>Case 2</b>						
Characteristic resistance in uncracked concrete C20/25	$N^0_{Rk,sp}$	[kN]	12	16	20	30
Edge distance	$c_{Cr,sp}$	[mm]	2,5 $h_{ef}$			
Increasing factor for $N_{Rk,p}$ and $N^0_{Rk,sp}$	$\psi_c$	[-]	$\left(\frac{f_{ck}}{20}\right)^{0,5}$			
<b>Concrete cone failure</b>						
Effective anchorage depth	$h_{ef}$	[mm]	45	58	65	80
Factor for uncracked concrete	$k_1 = k_{Ucr,N}$	[-]	11,0			

**Wedge anchor BZ-IG**

**Performance**

Characteristic values for tension loads, BZ-IG, uncracked concrete, static and quasi-static action

**Annex C12**

**Table C13: Characteristic values for shear loads, BZ-IG, cracked and uncracked concrete, static and quasi-static action**

Fastener size			M6	M8	M10	M12
Installation factor	$\gamma_{inst}$	[-]	1,0			
<b>BZ-IG, steel zinc plated</b>						
<b>Steel failure without lever arm, Pre-setting installation</b>						
Characteristic resistance	$V_{Rk,s}^0$	[kN]	5,8	6,9	10,4	25,8
<b>Steel failure without lever arm, Through-setting installation</b>						
Characteristic resistance	$V_{Rk,s}^0$	[kN]	5,1	7,6	10,8	24,3
<b>Steel failure with lever arm, Pre-setting installation</b>						
Characteristic bending resistance	$M_{Rk,s}^0$	[Nm]	12,2	30,0	59,8	104,6
<b>Steel failure with lever arm, Through-setting installation</b>						
Characteristic bending resistance	$M_{Rk,s}^0$	[Nm]	36,0	53,2	76,0	207
Partial factor for $V_{Rk,s}$ and $M_{Rk,s}^0$	$\gamma_{Ms}$	[-]	1,25			
Ductility factor	$k_7$	[-]	1,0			
<b>BZ-IG, stainless steel A4, HCR</b>						
<b>Steel failure without lever arm, Pre-setting installation</b>						
Characteristic resistance	$V_{Rk,s}^0$	[kN]	5,7	9,2	10,6	23,6
Partial factor	$\gamma_{Ms}$	[-]	1,25			
<b>Steel failure without lever arm, Through-setting installation</b>						
Characteristic resistance	$V_{Rk,s}^0$	[kN]	7,3	7,6	9,7	29,6
Partial factor	$\gamma_{Ms}$	[-]	1,25			
<b>Steel failure with lever arm, Pre-setting installation</b>						
Characteristic bending resistance	$M_{Rk,s}^0$	[Nm]	10,7	26,2	52,3	91,6
Partial factor	$\gamma_{Ms}$	[-]	1,56			
<b>Steel failure with lever arm, Through-setting installation</b>						
Characteristic bending resistance	$M_{Rk,s}^0$	[Nm]	28,2	44,3	69,9	191,2
Partial factor	$\gamma_{Ms}$	[-]	1,25			
Ductility factor	$k_7$	[-]	1,0			
<b>Concrete pry-out failure</b>						
Pry-out factor	$k_8$	[-]	1,5	1,5	2,0	2,0
<b>Concrete edge failure</b>						
Effective length of fastener in shear loading	$l_f$	[mm]	45	58	65	80
Effective diameter of fastener	$d_{nom}$	[mm]	8	10	12	16

**Wedge anchor BZ-IG**

**Performance**

Characteristic values for shear loads, BZ-IG, cracked and uncracked concrete, static and quasi-static action

**Annex C13**

**Table C14:** Characteristic values for **tension** and **shear load** under **fire exposure, BZ-IG**, cracked and uncracked concrete C20/25 to C50/60

Fastener size		M6	M8	M10	M12		
<b>Tension load</b>							
<b>Steel failure</b>							
<b>Steel zinc plated</b>							
Characteristic resistance	R30	$N_{Rk,s,fi}$	[kN]	0,7	1,4	2,5	3,7
	R60			0,6	1,2	2,0	2,9
	R90			0,5	0,9	1,5	2,2
	R120			0,4	0,8	1,3	1,8
<b>Stainless steel A4, HCR</b>							
Characteristic resistance	R30	$N_{Rk,s,fi}$	[kN]	2,9	5,4	8,7	12,6
	R60			1,9	3,8	6,3	9,2
	R90			1,0	2,1	3,9	5,7
	R120			0,5	1,3	2,7	4,0
<b>Shear load</b>							
<b>Steel failure without lever arm</b>							
<b>Steel zinc plated</b>							
Characteristic resistance	R30	$V_{Rk,s,fi}$	[kN]	0,7	1,4	2,5	3,7
	R60			0,6	1,2	2,0	2,9
	R90			0,5	0,9	1,5	2,2
	R120			0,4	0,8	1,3	1,8
<b>Stainless steel A4, HCR</b>							
Characteristic resistance	R30	$V_{Rk,s,fi}$	[kN]	2,9	5,4	8,7	12,6
	R60			1,9	3,8	6,3	9,2
	R90			1,0	2,1	3,9	5,7
	R120			0,5	1,3	2,7	4,0
<b>Steel failure with lever arm</b>							
<b>Steel zinc plated</b>							
Characteristic resistance	R30	$M^0_{Rk,s,fi}$	[Nm]	0,5	1,4	3,3	5,7
	R60			0,4	1,2	2,6	4,6
	R90			0,4	0,9	2,0	3,4
	R120			0,3	0,8	1,6	2,8
<b>Stainless steel A4, HCR</b>							
Characteristic resistance	R30	$M^0_{Rk,s,fi}$	[Nm]	2,2	5,5	11,2	19,6
	R60			1,5	3,9	8,1	14,3
	R90			0,7	2,2	5,1	8,9
	R120			0,4	1,3	3,5	6,2

**Wedge anchor BZ-IG**

**Performance**

Characteristic values for **tension** and **shear loads** under **fire exposure, BZ-IG** cracked and uncracked concrete C20/25 to C50/60

**Annex C14**



**Table C15: Displacements under tension load, BZ-IG**

Fastener size			M6	M8	M10	M12
Tension load in cracked concrete	N	[kN]	2,0	3,6	4,8	8,0
Displacements	$\delta_{N0}$	[mm]	0,6	0,6	0,8	1,0
	$\delta_{N\infty}$	[mm]	0,8	0,8	1,2	1,4
Tension load in uncracked concrete	N	[kN]	4,8	6,4	8,0	12,0
Displacements	$\delta_{N0}$	[mm]	0,4	0,5	0,7	0,8
	$\delta_{N\infty}$	[mm]	0,8	0,8	1,2	1,4

**Table C16: Displacements under shear load, BZ-IG**

Fastener size			M6	M8	M10	M12
Shear load in cracked and uncracked concrete	V	[kN]	4,2	5,3	6,2	16,9
Displacements	$\delta_{V0}$	[mm]	2,8	2,9	2,5	3,6
	$\delta_{V\infty}$	[mm]	4,2	4,4	3,8	5,3

**Wedge anchor BZ-IG**

**Performance**  
Displacements under tension load and under shear load **BZ-IG**

**Annex C15**