



... eine starke Verbindung

DEKLARACJA WŁAŚCIWOŚCI UŻYTKOWYCH

DoP Nr: MKT-1.2-201_pl

- ✧ **Niepowtarzalny kod identyfikacyjny typu wyrobu:** MKT Wedge kotwica B A4 i B HCR
- ✧ **Zamierzone zastosowanie lub zastosowania:** Dyble do kotwienia w betonie dla redundantnych systemów nienośnych, patrz załącznik B /Annex B
- ✧ **Producent:** MKT Metall-Kunststoff-Technik GmbH & Co.KG
Auf dem Immel 2
67685 Weilerbach
- ✧ **System(-y) oceny i weryfikacji stałości właściwości użytkowych:** 2+
- ✧ **Europejski dokument oceny:** EAD 330747-00-0601
Europejska ocena techniczna: ETA-06/0155, 02.05.2022
Jednostka ds. oceny technicznej: DIBt, Berlin
Jednostka lub jednostki notyfikowane: NB 2873 – Technische Universität Darmstadt

✧ **Deklarowane właściwości użytkowe:**

Zasadnicze charakterystyki	Właściwości użytkowe
Bezpieczeństwo pożarowe (BWR 2)	
Zachowanie ogień	Klasa A1
Odporność ogniowa	Załącznik / Annex C1
Bezpieczeństwo podczas użytkowania (BWR 4)	
Nośność charakterystyczna dla wszystkich kierunków obciążenia i wszystkich trybów zniszczenia dla uproszczonej metody projektowania	Załącznik / Annex C1
Trwałość	Załącznik / Annex B1

Właściwości użytkowe określonego powyżej wyrobu są zgodne z zestawem deklarowanych właściwości użytkowych. Niniejsza deklaracja właściwości użytkowych wydana zostaje zgodnie z rozporządzeniem (UE) nr 305/2011 na wyłączną odpowiedzialność producenta określonego powyżej.

W imieniu producenta podpisał(-a):

Stefan Weustenhagen
 (Kierownik)
 Weilerbach, 02.05.2022

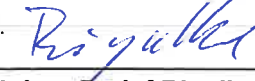
p.p. 
Dipl.-Ing. Detlef Bigalke
 (Kierownik Rozwoju Produktu)



Oryginał tej deklaracji właściwości użytkowych został sporządzony w języku niemieckim. W przypadku odchyień w tłumaczeniu obowiązuje wersja niemiecka.

Specifications of intended use

Multiple use for non-structural applications according to EN 1992-4:2018		
Wedge Anchor B A4 / B HCR	30 M6	40 M6
Stainless steel A4		✓
High corrosion resistant steel HCR		✓
Static and quasi-static actions		✓
Fire exposure		✓
Cracked and uncracked concrete		✓

Base materials:

- Reinforced or unreinforced normal weight concrete without fibres according to EN 206:2013 + A1:2016
- Strength classes C20/25 to C50/60 according to EN 206:2013 + A1:2016

Use conditions (Environmental conditions):

- Structures subject to dry internal conditions (all materials)
- For all other conditions:

Anchor version	Use according to EN 1993-1-4:2015 corresponding to the corrosion resistance class CRC according to Annex A, Table A.2
B A4	CRC III
B HCR	CRC V

Design:

- Anchorages are designed under the responsibility of an engineer experienced in anchorages and concrete work.
- Verifiable calculation notes and drawings are prepared taking account of the loads to be anchored. The position of the anchor is indicated on the design drawings (e.g. position of the anchor relative to reinforcement or to supports, etc.).
- Anchorages are designed according to EN 1992-4:2018 (and EOTA Technical Report TR 055:2018), design method B

Installation:

- Hole drilling by hammer drill bit or vacuum drill bit.
- Anchor installation such that the effective anchorage depth is complied with. This compliance is ensured, if the thickness of fixture is not greater than the maximum thickness of fixture marked on the anchor in accordance with Annex A2 and the hexagon nut is placed at the end of the conical bolt as delivered by the manufacturer.
- Use of the fastener only as supplied by the manufacturer without exchanging the components of the fastener.

MKT Wedge anchor B A4 and B HCR	Annex B1
Intended use Specifications	

Table B1: Installation parameters

Anchor size		30 M6	40 M6
Nominal drill hole diameter	$d_0 =$ [mm]	6	6
Cutting diameter of drill bit	$d_{cut} \leq$ [mm]	6,40	6,40
Installation torque	$T_{inst} =$ [Nm]	8	8
Depth of drill hole	$h_1 \geq$ [mm]	45	55
Effective embedment depth	$h_{ef} \geq$ [mm]	30	40
Minimum thickness of concrete member	h_{min} [mm]	80	80
Minimum spacing	s_{min} [mm]	50	50
Minimum edge distance	c_{min} [mm]	50	50
Diameter of clearance hole in the fixture	$d_f \leq$ [mm]	7	7

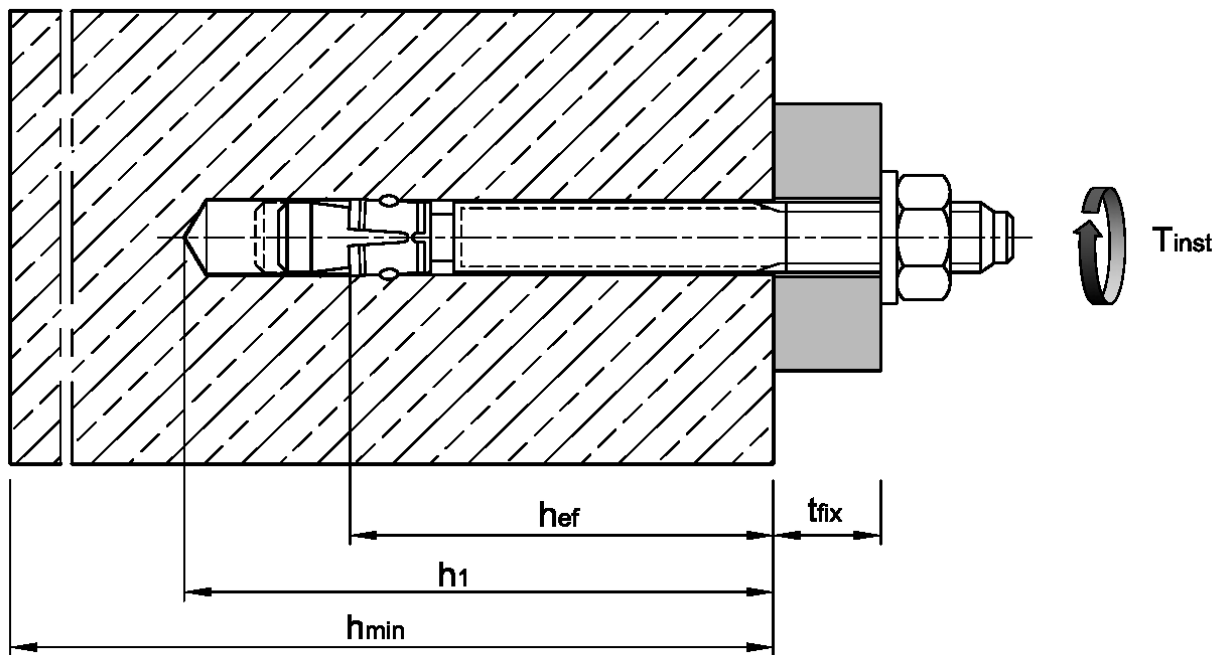

MKT Wedge anchor B A4 and B HCR

Intended use
Installation parameters

Annex B2

Installation instructions

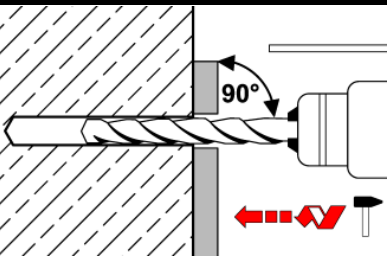
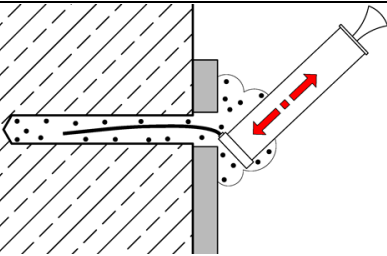
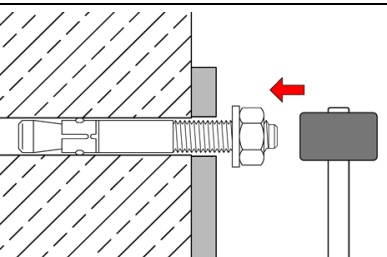
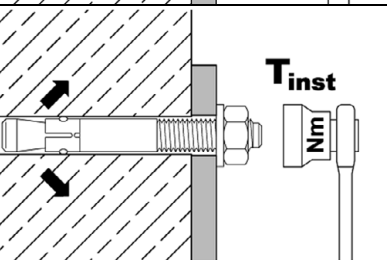
1		<p>Drill hole perpendicular to concrete surface. If using a vacuum drill bit, proceed with step 3.</p>
2		<p>Blow out dust. Alternatively, vacuum clean down to the bottom of the hole.</p>
3		<p>Drive in anchor. Observe effective anchorage depth. This is ensured, if the thickness of fixture is not greater than the maximum thickness of fixture marked on the anchor (according to Annex A2).</p>
4		<p>Apply installation torque T_{inst} by using torque wrench.</p>

MKT Wedge anchor B A4 and B HCR

Intended use
Installation instructions

Annex B3

Table C1: Characteristic values of resistance, design method B

Anchor size			30 M6	40 M6
All load directions				
Characteristic resistance in C20/25 to C50/60	F_{Rk}^0	[kN]	5	6
Partial factor ¹⁾	γ_M	[-]	2,16	1,8
Design resistance in C20/25 to C50/60	F_{Rd}^0	[kN]	2,3	3,3
Spacing	s_{cr}	[mm]	260	370
Edge distance	c_{cr}	[mm]	130	185
Shear load with lever arm				
Characteristic bending resistance	$M_{Rk,s}^0$	[Nm]	10	10
Partial factor ¹⁾	γ_{Ms}	[-]	1,25	1,25

¹⁾ in absence of other national regulations

Table C2: Characteristic values under fire exposure in concrete C20/25 to C50/60, design method B

Anchor size			30 M6 40 M6
Fire resistance class	In any load direction		
R 30	Characteristic resistance	$F_{Rk,fi30}^0$	[kN] 0,6
	Characteristic bending resistance	$M_{Rk,s,fi30}^0$	[Nm] 0,5
R 60	Characteristic resistance	$F_{Rk,fi60}^0$	[kN] 0,5
	Characteristic bending resistance	$M_{Rk,s,fi60}^0$	[Nm] 0,4
R 90	Characteristic resistance	$F_{Rk,fi90}^0$	[kN] 0,3
	Characteristic bending resistance	$M_{Rk,s,fi90}^0$	[Nm] 0,3
R 120	Characteristic resistance	$F_{Rk,fi120}^0$	[kN] 0,3
	Characteristic bending resistance	$M_{Rk,s,fi120}^0$	[Nm] 0,2
R 30 to R 120	Spacing	$s_{cr,fi}$	[mm] 4 h_{ef}
		s_{min}	[mm] 50
	Edge distance	$c_{cr,fi}$	[mm] 2 h_{ef}
		c_{min}	[mm] 50
	Partial factor	$\gamma_{M,fi}$	[-] 1,0
If the fire attacks from more than one side, the edge distance of the anchor shall be ≥ 300 mm.			

MKT Wedge anchor B A4 and B HCR

Performances

Characteristic resistances under normal ambient temperature and fire exposure, design method B

Annex C1