



...eine starke Verbindung

IZJAVA O LASTNOSTIH

DoP Št.: **MKT-151 - sl**

- ✧ **Enotna identifikacijska oznaka tipa proizvoda:** Bolt sidro B A4 in B HCR
- ✧ **Predvidena uporaba:** Drogovi iz nerjavečega jekla v velikosti 30 M6 in 40 M6za uporabo kot večkratno pritrjevanje nestrukturnih sistemov v beton, glej Priloga/Annex B
- ✧ **Proizvajalec:** MKT Metall-Kunststoff-Technik GmbH & Co.KG
Auf dem Immel 2
67685 Weilerbach
- ✧ **Sistemi ocenjevanja in preverjanja nespremenljivosti lastnosti:** 2+
- ✧ **Evropski ocenjevalni dokument:** **ETAG 001-6**
Evropska tehnična ocena: **ETA-06/0155, 09.05.2018**
Organ za tehnično ocenjevanje: DIBt, Berlin
Priglašeni organi: NB 1343 – MPA, Darmstadt

✧ **Navedene lastnosti:**

Bistvene značilnosti	Lastnosti
Varnost pri požaru (BWR2)	
Ogenj vedenje	Razred A1
Požarna odpornost	Priloga/Annex C1
Varnost pri uporabi (BWR4)	
Karakteristične vrednosti za vse smeri obremenitve	Priloga/Annex C1

Lastnosti proizvoda, navedenega zgoraj, so v skladu z navedenimi lastnostmi. Za izdajo te izjave o lastnostih je v skladu z Uredbo (EU) št. 305/2011 odgovoren izključno proizvajalec, naveden zgoraj.

Podpisal za in v imenu proizvajalca:

Stefan Weustenhagen
(Generalni direktor)

Weilerbach, 09.05.2018

p.p. 
Dipl.-Ing. Detlef Bigalke
(Vodja razvoja izdelkov)



Izvirnik te izjave o uspehu je bil napisan v nemškem jeziku. V primeru odstopanj v prevodu je nemška različica veljavna.

Specifications of intended use

Multiple use for non-structural applications, according to ETAG 001 Part 6, Edition August 2010

Anchorage subject to:

- static and quasi-static loads
- fire exposure

Base materials:

- Reinforced or unreinforced normal weight concrete according to EN 206-1:2000
- Strength classes C20/25 to C50/60 according to EN 206-1:2000
- Cracked and uncracked concrete

Use conditions (Environmental conditions):

- Structures subject to dry internal conditions (stainless steel or high corrosion resistant steel).
- Structures subject to external atmospheric exposure (including industrial and marine environment) and to permanently damp internal condition, if no particular aggressive conditions exist (stainless steel or high corrosion resistant steel).
- Structures subject to external atmospheric exposure and to permanently damp internal condition, if other particular aggressive conditions (high corrosion resistant steel).

Note: Particular aggressive conditions are e.g. permanent, alternating immersion in seawater or the splash zone of seawater, chloride atmosphere of indoor pools or atmosphere with extreme chemical pollution (e.g. in desulphurization plants or road tunnels where de-icing materials are used.)

Design:

- Anchorages are designed under the responsibility of an engineer experienced in anchorages and concrete work.
- Verifiable calculation notes and drawings are prepared taking account of the loads to be anchored. The position of the anchor is indicated on the design drawings (e.g. position of the anchor relative to reinforcement or to supports, etc.).
- Anchorages under static or quasi-static actions for multiple use in non-structural applications are designed in accordance with:
 - ETAG 001, Annex C, design method B, Edition August 2010 or
 - CEN/TS 1992-4: 2009, design method B
- Anchorages under fire exposure are designed in accordance with:
 - ETAG 001, Annex C, design method B, Edition August 2010 and EOTA Technical Report TR 020, Edition May 2004 or
 - CEN/TS 1992-4: 2009, Annex D
 - It must be ensured that local spalling of the concrete cover does not occur.

Installation:

- Anchor installation carried out by appropriately qualified personnel and under the supervision of the person responsible for technical matters of the site,
- Anchor installation in accordance with the manufacturer's specifications and drawings and using the appropriate tools,
- Positioning of the drill holes without damaging the reinforcement.
- Anchor installation such that the effective anchorage depth is complied with. This compliance is ensured, if the thickness of fixture is not greater than the maximum thickness of fixture marked on the anchor in accordance with Annex A2 and the hexagon nut is placed at the end of the conical bolt as delivered by the manufacturer.

Wedge Anchor B A4 and B HCR

Intended use
Specifications

Annex B1

Table B1: Installation parameters

Anchor size		30 M6	40 M6
Nominal drill hole diameter	$d_0 =$ [mm]	6	6
Cutting diameter of drill bit	$d_{cut} \leq$ [mm]	6,40	6,40
Tightening torque	$T_{inst} =$ [Nm]	8	8
Drill hole depth	$h_1 \geq$ [mm]	45	55
Effective embedment depth	$h_{ef} \geq$ [mm]	30	40
Minimum thickness of concrete member	h_{min} [mm]	80	80
Minimum spacing	s_{min} [mm]	50	50
Minimum edge distance	c_{min} [mm]	50	50
Diameter of clearance hole in the fixture	$d_f \leq$ [mm]	7	7

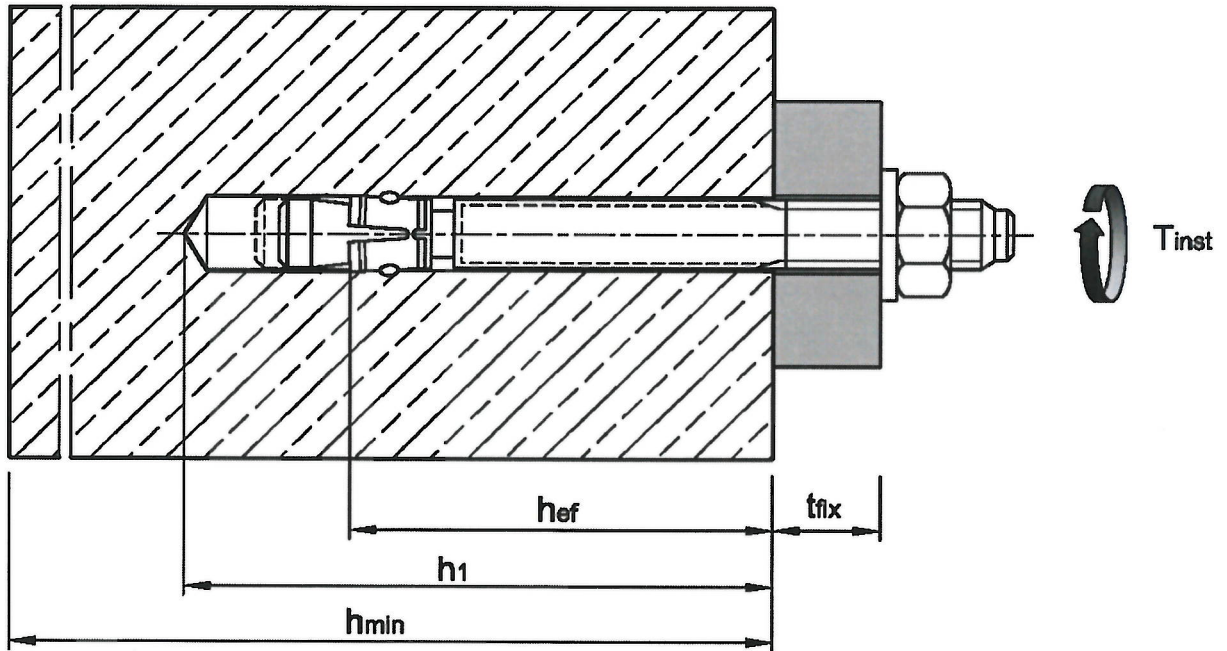

Wedge Anchor B A4 and B HCR

Intended use
Installation parameters

Annex B2

Installation instructions

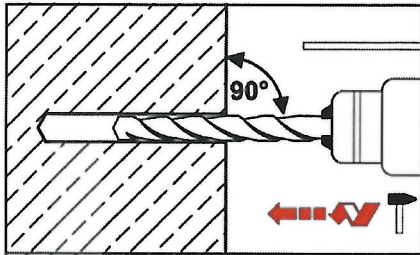

Drill hole perpendicular to concrete surface, positioning of the drill holes without damaging the reinforcement.
 In case of aborted hole: new drilling at a minimum distance away of twice the depth of the aborted hole or smaller distance if the aborted drill hole is filled with high strength mortar and if under shear or oblique tension load it is not in the direction of load application.

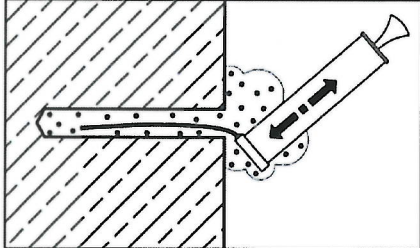

Blow out dust.

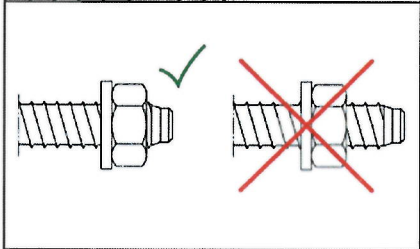

Check position of nut.

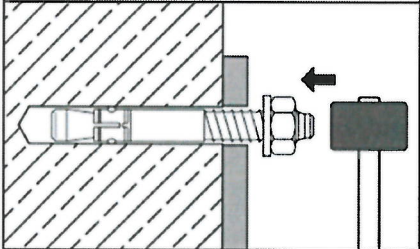

Drive in anchor.
 Observe effective anchorage depth. This is ensured, if the thickness of fixture is not greater than the maximum thickness of fixture marked on the anchor (acc. to Annex A2).

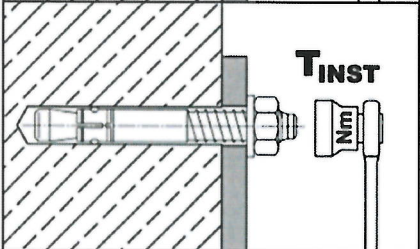

Apply installation torque T_{inst} by using torque wrench.

Wedge Anchor B A4 and B HCR

Intended use
 Installation Instructions

Annex B3

Table C1: Characteristic values of resistance, design method B

Anchor size			30 M6	40 M6
All load directions				
Characteristic resistance in C20/25 to C50/60	F_{Rk}^0	[kN]	5	6
Partial factor	γ_M	[-]	2,16	1,8
Design resistance in C20/25 to C50/60	F_{Rd}^0	[kN]	2,3	3,3
Spacing	s_{cr}	[mm]	260	370
Edge distance	c_{cr}	[mm]	130	185
Shear load with lever arm				
Characteristic bending resistance	$M_{Rk,s}^0$ ¹⁾	[Nm]	10	10
Partial factor	γ_{Ms}	[-]	1,25	1,25

¹⁾ Characteristic bending resistance $M_{Rk,s}^0$ for equation (5.5) in ETAG 001, Annex C respectively equation (14) CEN/TS 1992-4-4

Table C2: Characteristic values under fire exposure in concrete C20/25 to C50/60, design method B

Anchor size			30 M6 40 M6
Fire resistance class	In any load direction		
R 30	Characteristic resistance	$F_{Rk,fi30}^0$	[kN] 0,6
	Characteristic bending resistance	$M_{Rk,s,fi30}^0$	[Nm] 0,5
R 60	Characteristic resistance	$F_{Rk,fi60}^0$	[kN] 0,5
	Characteristic bending resistance	$M_{Rk,s,fi60}^0$	[Nm] 0,4
R 90	Characteristic resistance	$F_{Rk,fi90}^0$	[kN] 0,3
	Characteristic bending resistance	$M_{Rk,s,fi90}^0$	[Nm] 0,3
R 120	Characteristic resistance	$F_{Rk,fi120}^0$	[kN] 0,3
	Characteristic bending resistance	$M_{Rk,s,fi120}^0$	[Nm] 0,2
R 30 to R 120	Spacing	$s_{cr,fi}$	[mm] 4 h_{ef}
		s_{min}	[mm] 50
	Edge distance	$c_{cr,fi}$	[mm] 2 h_{ef}
		c_{min}	[mm] 50
	Partial factor	$\gamma_{M,fi}$	[-] 1,0
If the fire attacks from more than one side, the edge distance shall be ≥ 300 mm.			

Wedge Anchor B A4 and B HCR

Performance
Characteristic resistances under normal ambient temperature and fire exposure, design method B

Annex C1