

PRESTANDEDEKLARATION

DoP Nr: **MKT-1.1-301_sv**

- ◇ **Produkttypens unika identifikationskod:** **Drop-in ankare E / ES**
- ◇ **Avsedd användning/avsedda användningar:** Mekanisk plugg för förankring i betong, se bilaga/Annex B
- ◇ **Tillverkare:** MKT Metall-Kunststoff-Technik GmbH & Co.KG
Auf dem Immel 2
67685 Weilerbach
- ◇ **System för bedömning och fortlöpande kontroll av prestanda:** 1
- ◇ **Europeiskt bedömningsdokument:** **EAD 330232-01-0601**
Europeisk teknisk bedömning: **ETA-02/0020, 01.06.2021**
Tekniskt bedömningsorgan: DIBt, Berlin
Anmält/anmälda organ: NB 2873 – Technische Universität Darmstadt
- ◇ **Angiven prestanda:**

Väsentliga egenskaper	Prestanda
Bärförmåga, stadga och beständighet (BWR 1)	
Karakteristiska motstånd under dragbelastning (statiska och kvasistatiska effekter), Metod A	Bilaga/Annex B2, C1 – C2
Karakteristiska motstånd under tvärspanning (statiska och kvasistatiska effekter)	Bilaga/Annex C3 – C4
Skift	Bilaga/Annex C5
Hållbarhet	Bilaga/Annex B1
Karaktäristiska motstånd och förskjutningar för de seismiska prestandakategorierna C1 + C2	Ingen prestationsbedömning
Säkerhet vid brand (BWR 2)	
Brandegenskaper	Klass A1
Brandmotstånd	Ingen prestationsbedömning

Prestandan för ovanstående produkt överensstämmer med den angivna prestandan. Denna prestandadeklaration har utfärdats i enlighet med förordning (EU) nr 305/2011 på eget ansvar av den tillverkare som anges ovan.

Undertecknad på tillverkarens vägnar av:

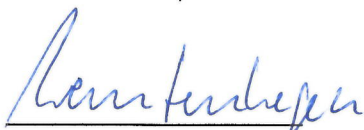

Stefan Weustenhagen
(Verkställande direktör)
Weilerbach, 01.06.2021

p.p.

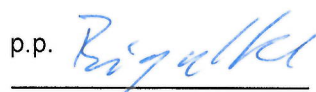

Dipl.-Ing. Detlef Bigalke
(Produktutveckling direktör)



Originalen av denna deklaraionsförklaring skrevs på tyska. Vid avvikelser i översättningen gäller den tyska versionen.

Specifications of intended use

Anchorage subject to:

- Static and quasi-static loads

Base materials:

- Compacted, reinforced or unreinforced normal weight concrete, without fibres according to EN 206:2013 + A1:2016
- Uncracked concrete
- Strength classes C20/25 to C50/60 according to EN 206:2013 + A1:2016

Use conditions (Environmental conditions):

- Structures subject to dry internal conditions (all materials)
- For all other conditions applies:
Use according to EN 1993-1-4:2015 corresponding to corrosion resistance class CRC according to Annex A2, Table A1:
 - Stainless steel A4: CRC III
 - High corrosion resistant steel HCR: CRC V
- Anchor types M6x30 A4 and M8x30 A4 only for dry internal exposure

Design:

- Anchorages are designed under the responsibility of an engineer experienced in anchorages and concrete work.
- Verifiable calculation notes and drawings are prepared taking account of the loads to be anchored. The position of the anchor is indicated on the design drawings (e.g. position of the anchor relative to reinforcement or to supports, etc.).
- The strength class and the length of the fastening screw or threaded rod shall be defined by the designing engineer
- Design of fastenings according EN 1992-4:2018 (and TR 055, if necessary)
- Anchor sizes M6x30, M8x30 and M10x30 for statically indeterminate structural components only, when in case of failure, the load can be distributed to other fasteners.

Installation:

- Anchor installation in accordance with the manufacturer's specifications and drawings and using the appropriate tools
- Drill hole by hammer drilling or vacuum drilling

Drop-in Anchor E / ES

Intended use
Specifications

Annex B1

Table B1: Installation parameters

Anchor size		M6x30	M8x30	M8x40	M10x30	M10x40	M12x50	M12x80	M16x65	M16x80	M20x80
Depth of drill hole	$h_0 =$ [mm]	30	30	40	30	40	50	80	65	80	80
Drill hole diameter	$d_0 =$ [mm]	8	10	10	12	12	15	15	20	20	25
Cutting diameter of drill bit	$d_{cut} \leq$ [mm]	8,45	10,45	10,45	12,5	12,5	15,5	15,5	20,55	20,55	25,55
Max. installation torque ¹⁾	$T_{inst} \leq$ [Nm]	4	8	8	15	15	35	35	60	60	120
Diameter of clearance hole in the fixture	$d_f \leq$ [mm]	7	9	9	12	12	14	14	18	18	22
Thread length	L_{th} [mm]	13	13	20	12	15	18	45	23	38	34
Minimum screw-in depth	L_{sdmin} [mm]	7	9	9	10	11	13	13	18	18	22
Steel, zinc plated											
Minimum thickness of member	h_{min} [mm]	100	100	100	120	120	130	130	160	160	200
Minimum spacing	s_{min} [mm]	55	60	80	100	100	120	120	150	150	160
Minimum edge distance	c_{min} [mm]	95	95	95	115	135	165	165	200	200	260
Stainless steel A4, HCR											
Minimum thickness of member	h_{min} [mm]	100	100	100	-	130	140	140	160	160	250
Minimum spacing	s_{min} [mm]	50	60	80	-	100	120	120	150	150	160
Minimum edge distance	c_{min} [mm]	80	95	95	-	135	165	165	200	200	260

¹⁾ If the screw or threaded rod is otherwise secured against unscrewing, the torque can be omitted

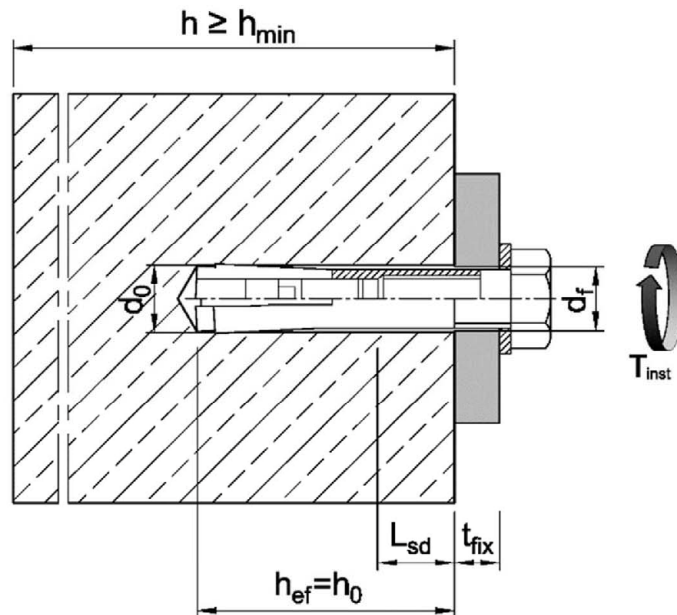

Drop-in Anchor E / ES

Intended use
Installation parameters

Annex B2

Installation instructions

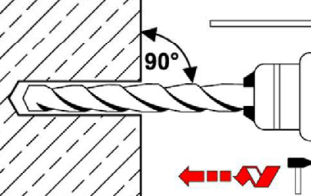
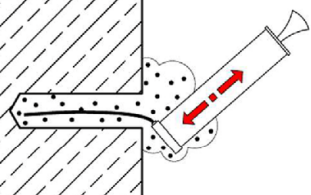
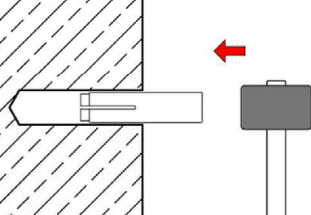
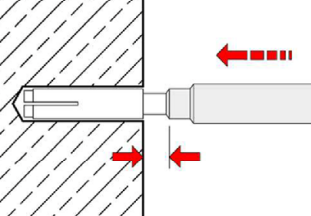
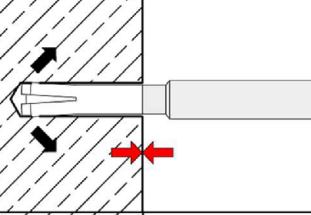
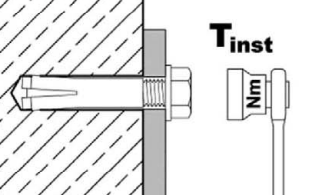
1		<p>Drill hole perpendicular to concrete surface. Using vacuum drill bit proceed with step 3.</p>
2		<p>Blow out dust. Alternatively, vacuum clean down to the bottom of the hole.</p>
3		<p>Drive in anchor.</p>
4		<p>Drive in cone by using setting tool.</p>
5		<p>Shoulder of setting tool must fit on anchor rim.</p>
6		<p>Turn in screw or threaded rod with nut, observe minimum screw-in depth (see Annex B2). Apply installation torque T_{inst}.</p>

Drop-in Anchor E / ES

Intended use
Installation instructions

Annex B3

Table C1: Characteristic values for tension loads, zinc plated steel

Anchor size			M6x30	M8x30	M8x40	M10x30	M10x40	M12x50	M12x80	M16x65 M16x80	M20x80		
Installation factor	γ_{inst}	[-]	1,2										
Steel failure													
Characteristic resistance	property class	4.6	$N_{Rk,s}$	[kN]	8,0	14,6		23,2		33,7		62,8	98,0
		4.8			8,0	14,6		18,0	20,2	33,7		62,8	98,0
		5.6			10,0	18,3		18,0	20,2	42,1		78,3	122,4
		5.8			10,0	17,6	18,3	18,0	20,2	40,2	42,1	67,1	106,4
		8.8			15,0	17,6	19,9	18,0	20,2	40,2	43,0	67,1	106,4
Partial factor	property class	4.6	γ_{Ms}^1	[-]	2,0								
		5.6			2,0		1,5		2,0				
		4.8										1,6	
		5.8			1,5								
		8.8										1,6	
Pull-out failure													
Characteristic resistance in concrete C20/25	$N_{Rk,p}$	[kN]	8,1	8,1	9,0	8,1	12,4	17,4	17,4	25,8	35,2		
Increasing factor	ψ_C	[-]	$\left(\frac{f_{ck}}{20}\right)^{0,5}$		$\left(\frac{f_{ck}}{20}\right)^{0,3}$	$\left(\frac{f_{ck}}{20}\right)^{0,5}$							
Splitting													
Characteristic resistance in concrete C20/25	$N^0_{Rk,sp}$	[kN]	$\min (N_{Rk,p} ; N^0_{Rk,c})$										
Characteristic edge distance	$c_{cr,sp}$	[mm]	95	95	95	115	135	165		200	260		
Characteristic spacing	$s_{cr,sp}$	[mm]	$2 \cdot c_{cr,sp}$										
Concrete cone failure													
Effective anchorage depth	h_{ef}	[mm]	30	30	40	30	40	50	80	65 80 ²⁾	80		
Characteristic edge distance	$c_{cr,N}$	[mm]	$1,5 h_{ef}$										
Characteristic spacing	$s_{cr,N}$	[mm]	$2 \cdot c_{cr,N}$										
Factor	uncracked concrete	$k_{ucr,N}$	11,0										
	cracked concrete	$k_{cr,N}$	No performance assessed										

¹⁾ in absence of other national regulations

²⁾ for M16x80

Drop-in Anchor E / ES

Performance
Characteristic values for **tension loads, zinc plated steel**

Annex C1

Table C2: Characteristic values for tension loads, stainless steel A4, HCR

Anchor size			M6x30	M8x30	M8x40	M10x40	M12x50 M12x80	M16x65 M16x80	M20x80
Installation factor	γ_{inst}	[-]	1,0						
Steel failure									
Characteristic resistance (property class 70)	$N_{Rk,s}$	[kN]	14,1	23,3		29,4	50,2	83,8	133,0
Characteristic resistance (property class 80)	$N_{Rk,s}$	[kN]	17,5	23,3		29,4	50,2	83,8	133,0
Partial factor	$\gamma_{Ms}^{1)}$	[-]	1,87						
Pull-out failure									
Characteristic resistance in concrete C20/25	$N_{Rk,p}$	[kN]	8,1	8,1	11,0	12,4	17,4	25,8	35,2
Increasing factor	ψ_C	[-]	$\left(\frac{f_{ck}}{20}\right)^{0,5}$		$\left(\frac{f_{ck}}{20}\right)^{0,3}$	$\left(\frac{f_{ck}}{20}\right)^{0,5}$			
Splitting failure									
Characteristic resistance in concrete C20/25	$N^0_{Rk,sp}$	[kN]	min ($N_{Rk,p}$; $N^0_{Rk,c}$)						
Edge distance	$c_{cr,sp}$	[mm]	80	95	95	135	165	200	260
Spacing	$s_{cr,sp}$	[mm]	$2 \cdot c_{cr,sp}$						
Concrete cone failure									
Effective anchorage depth	h_{ef}	[mm]	30	30	40	40	50 80 ²⁾	65 80 ²⁾	80
Edge distance	$c_{cr,N}$	[mm]	$1,5 h_{ef}$						
Spacing	$s_{cr,N}$	[mm]	$2 \cdot c_{cr,N}$						
Factor	uncracked concrete	$k_{ucr,N}$	11,0						
	cracked concrete	$k_{cr,N}$	No performance assessed						

1) in absence of other national regulations

2) for M12x80 and M16x80

Drop-in Anchor E / ES
Performance

 Characteristic values for **tension loads, stainless steel A4, HCR**
Annex C2

Table C3: Characteristic values for shear loads, zinc plated steel

Anchor size			M6x30	M8x30	M8x40	M10x30	M10x40	M12x50	M12x80	M16x65 M16x80	M20x80			
Steel failure without lever arm														
Characteristic resistance	property class	4.6	$V_{Rk,s}^0$	[kN]	4,0	7,3	11,6	9,6	16,8		31,3	49,0		
		4.8			4,0	7,3	10,1	10,1	16,9		31,3	49,0		
		5.6			5,0	9,1	10,1	9,6	21,1		39,2	61,2		
		5.8			5,0	6,9	10,1	7,2	19,4	21,1	33,5	53,2		
		8.8			5,0	6,9	10,1	7,2	19,4	21,5	33,5	53,2		
Partial factor	property class	4.6	$\gamma_{Ms}^{1)}$	[-]	1,67									
		5.6			1,67		1,25	1,67						
		4.8			1,25								1,33	
		5.8			1,25								1,33	
		8.8			1,25								1,33	
Duktilitätsfaktor			k_7	[-]	1,0									
Steel failure with lever arm														
Characteristic bending resistance	property class	4.6	$M_{Rk,s}^0$	[Nm]	6,1	15	30		52		133	259		
		4.8			7,6	19	37		65		166	324		
		5.6			12	30	59	60	105		266	519		
		5.8			1,67									
Partial factor	property class	4.6	$\gamma_{Ms}^{1)}$	[-]	1,67									
		5.6			1,67									
		4.8			1,25									
		5.8			1,25									
8.8	1,25													
Factor of ductility			k_7	[-]	1,0									
Concrete pry-out failure														
Pry-out factor			k_8	[-]	1,0			1,5	2,0					
Concrete edge failure														
Effective length of fastener in shear loading			l_f	[mm]	30	30	40	30	40	50	80	$\frac{65}{80}^{2)}$	80	
Outside diameter of fastener			d_{nom}	[mm]	8	10		12		15		20	25	

¹⁾ in absence of other national regulations

²⁾ for M16x80

Drop-in Anchor E / ES

Performance
Characteristic values for **shear loads, zinc plated steel**

Annex C3

Table C4: Characteristic values for shear loads, stainless steel A4, HCR

Anchor size			M6x30	M8x30	M8x40	M10x40	M12x50	M12x80	M16x65	M16x80	M20x80
Steel failure without lever arm											
Characteristic resistance (property class 70)	$V_{Rk,s}^0$	[kN]	7,0	10,6	13,4	25,1	41,9	66,5			
Characteristic resistance (property class 80)	$V_{Rk,s}^0$	[kN]	8,7	10,6	13,4	25,1	41,9	66,5			
Partial factor	$\gamma_{Ms}^{1)}$	[-]	1,56								
Factor of ductility	k_7	[-]	1,0								
Steel failure with lever arm											
Characteristic bending resistance (property class 70)	$M_{Rk,s}^0$	[Nm]	11	26	52	92	233	454			
Partial factor	$\gamma_{Ms}^{1)}$	[-]	1,56								
Characteristic bending resistance (property class 80)	$M_{Rk,s}^0$	[Nm]	12	30	60	105	266	519			
Partial factor	$\gamma_{Ms}^{1)}$	[-]	1,33								
Factor of ductility	k_7	[-]	1,0								
Concrete pry-out failure											
Pry-out factor	k_8	[-]	1,0	1,7					2,0		
Concrete edge failure											
Effective length of fastener in shear loading	l_f	[mm]	30	30	40	40	50	80	65	80	80
Outside diameter of fastener	d_{nom}	[mm]	8	10	12	15	20	25			

¹⁾ in absence of other national regulations

Drop-in Anchor E / ES

Performance
Characteristic values for shear loads, stainless steel A4, HCR

Annex C4

Table C5: Displacements under tension loads

Anchor size			M6x30	M8x30	M8x40	M10x30	M10x40	M12x50 M12x80	M16x65 M16x80	M20x80
Steel, zinc plated										
Tension load in uncracked concrete	N	[kN]	3	3	3,6	3,3	4,8	6,4	10	14,8
Displacements	δ_{N0}	[mm]	0,24							
	$\delta_{N\infty}$	[mm]	0,36							
Stainless steel A4 / HCR										
Tension load in uncracked concrete	N	[kN]	4	4	4,3	- ¹⁾	6,1	8,5	12,6	17,2
Displacements	δ_{N0}	[mm]	0,12							
	$\delta_{N\infty}$	[mm]	0,24							

¹⁾ Anchor version is not part of the ETA

Table C6: Displacements under shear loads

Anchor size			M6x30	M8x30	M8x40	M10x30	M10x40	M12x50 M12x80	M16x65 M16x80	M20x80
Steel, zinc plated										
Shear load in uncracked concrete	V	[kN]	2	4	4	5,7	4,0	11,3	18,8	32,2
Displacements	δ_{V0}	[mm]	0,9	0,9	1,0	1,5	0,6	1,2	1,2	1,6
	$\delta_{V\infty}$	[mm]	1,3	1,3	1,5	2,3	0,9	1,9	1,9	2,4
Stainless steel A4 / HCR										
Shear load in uncracked concrete	V	[kN]	3,5	5,2	5,2	- ¹⁾	6,5	11,5	19,2	30,4
Displacements	δ_{V0}	[mm]	1,9	1,1	0,7	- ¹⁾	1,0	1,7	2,4	2,6
	$\delta_{V\infty}$	[mm]	2,8	1,6	1,0	- ¹⁾	1,5	2,6	3,6	3,8

¹⁾ Anchor version is not part of the ETA

Drop-in Anchor E / ES

Performance
Displacements

Annex C5