

IZJAVA O SVOJSTVIMA

DoP Br. MKT-1.2-101_hr

- ✧ **Jedinstvena identifikacijska oznaka vrste proizvoda:** Sidro E / ES
- ✧ **Namjena/namjene:** Tipli za sidrenje u betonu za suvišne neopterećene sustave, vidi Prilog/Annex B
- ✧ **Proizvođač:** MKT Metall-Kunststoff-Technik GmbH & Co.KG
Auf dem Immel 2
67685 Weilerbach
- ✧ **Sustav/sustavi za ocjenu i provjeru stalnosti svojstava (AVCP):** 2+
- ✧ **Europski dokument za ocjenjivanje:** **EAD 330747-00-0601**
Europska tehnička ocjena: **ETA-05/0116, 27.05.2021**
Tijelo za tehničko ocjenjivanje: DIBt, Berlin
Prijavljeno tijelo/prijavljena tijela: NB 2873 – Technische Universität Darmstadt

✧ **Objavljena svojstva:**

Bitnih značajka	Svojstva
Sigurnost u slučaju požara (BWR 2)	
Ponašanje požara	Klasa A1
Otpornost na vatru	Prilog/Annex C5
Sigurnost tijekom uporabe (BWR 4)	
Karakteristična otpornost za sve smjerove opterećenja i sve načine otkaza za pojednostavljenu metodu dizajna	Prilog/Annex B3, C1 – C4
Trajnost	Prilog/Annex B1

Prije utvrđeno svojstvo proizvoda u skladu je s objavljenim svojstvima. Ova izjava o svojstvima izdaje se, u skladu s Uredbom (EU) br. 305/2011, pod isključivom odgovornošću prethodno utvrđenog proizvođača.

Za proizvođača i u njegovo ime potpisao:

Stefan Weustenhagen
(generalni direktor)

Weilerbach, 27.05.2021

p.p. 
Dipl.-Ing. Detlef Bigalke
(Voditelj razvoja proizvoda)



Izvornik ove izjave o izvedbi pisan je na njemačkom jeziku. U slučaju odstupanja u prijevodu vrijedi njemačka verzija.

Specifications of intended use

Drop-in Anchor E / ES	Anchorage depth $h_{ef} \geq 30$ mm						
	M6x30	M8x30	M8x40	M10x30	M10x40	M12x50	M16x65
Steel, zinc plated				✓			
Stainless steel A4 and high corrosion resistant steel HCR		✓		-		✓	
Static and quasi-static loads				✓			
Fire exposure				✓			
Cracked and uncracked concrete				✓			
Solid concrete C20/25 to C50/60				✓			

Drop-in Anchor ES	Anchorage depth $h_{ef} = 25$ mm			
	M6x25	M8x25	M10x25	M12x25
Steel, zinc plated			✓	
Stainless steel A4 and high corrosion resistant steel HCR			-	
Static and quasi-static loads			✓	
Fire exposure (solid concrete, C20/25 to C50/60)			✓	
Cracked and uncracked concrete			✓	
Solid concrete C12/15 to C50/60			✓	
Precast pre-stressed hollow core slabs C30/37 to C50/60			✓	

Use only for redundant, non-structural systems!

Base materials:

- Compacted, reinforced or unreinforced normal weight concrete (without fibers) acc. to EN 206:2013 + A1:2016

Use conditions:

- Structures subject to dry internal conditions (zinc plated steel, stainless steel or high corrosion resistant steel)
- Structures subject to external atmospheric exposure (including industrial and marine environment) or exposure to permanently damp internal condition, if no particular aggressive conditions exist (stainless steel or high corrosion resistant steel)
- Structures subject to external atmospheric exposure and to permanently damp internal condition, if other particular aggressive conditions (high corrosion resistant steel)

Note: Particular aggressive conditions are e.g. permanent, alternating immersion in seawater or the splash zone of seawater, chloride atmosphere of indoor pools or atmosphere with extreme chemical pollution (e.g. in desulphurization plants or road tunnels where de-icing materials are used.)

Drop-in Anchor E / ES	Annex B1
Intended use Specifications	

Specifications of intended use

Design:

- Anchorages are designed under the responsibility of an engineer experienced in anchorages and concrete work
- Verifiable calculation notes and drawings are prepared taking account of the loads to be anchored. The position of the anchor is indicated on the design drawings (e.g. position of the anchor relative to reinforcement or to supports, etc.)
- The strength class and the length of the fastening screw or threaded rod shall be defined by the designing engineer
- Anchorages are designed acc. to EN 1992-4:2018 (if necessary in connection with TR 055)

Installation:

- Anchor installation in accordance with the manufacturer's specifications and drawings and using the appropriate tools
- Drill hole by hammer drilling or vacuum drilling

Drop-in Anchor E / ES

Intended use
Specifications

Annex B2

Table B1: Installation parameters for $h_{ef} \geq 30$ mm

Anchor size			M6x30	M8x30	M8x40	M10x30	M10x40	M12x50	M16x65
Depth of drill hole E	$h_0 =$	[mm]	30	30	40	30	40	50	65
Depth of drill hole ES	$h_0 \geq$	[mm]	30	30	40	30	40	50	65
Drill hole diameter	$d_0 =$	[mm]	8	10	10	12	12	15	20
Cutting diameter of drill bit	$d_{cut} \leq$	[mm]	8,45	10,45	10,45	12,5	12,5	15,5	20,55
Maximum installation torque	$T_{inst} \leq$	[Nm]	4	8	8	15	15	35	60
Diameter of clearance hole in the fixture	$d_f \leq$	[mm]	7	9	9	12	12	14	18
Thread length	L_{th}	[mm]	13	13	20	12	15	18	23
Minimum screw-in depth	L_{sdmin}	[mm]	7	9	9	10	11	13	18
Steel, zinc plated									
Minimum thickness of member	h_{min}	[mm]	100	100	100	120	120	130	160
Minimum spacing	s_{min}	[mm]	55	60	80	100	100	120	150
Minimum distance	c_{min}	[mm]	95	95	95	115	135	165	200
Stainless steel A4, HCR									
Minimum thickness of member	h_{min}	[mm]	100	100	100	-	130	140	160
Minimum spacing	s_{min}	[mm]	50	60	80	-	100	120	150
Minimum distance	c_{min}	[mm]	80	95	95	-	135	165	200

Table B2: Installation parameters for $h_{ef} = 25$ mm

Anchor size			M6x25	M8x25	M10x25	M12x25
Depth of drill hole	$h_0 \geq$	[mm]	25	25	25	25
Drill hole diameter	$d_0 =$	[mm]	8	10	12	15
Cutting diameter of drill bit	$d_{cut} \leq$	[mm]	8,45	10,45	12,5	15,5
Maximum installation torque	$T_{inst} \leq$	[Nm]	4	8	15	35
Diameter of clearance hole in the fixture	$d_f \leq$	[mm]	7	9	12	14
Thread length	L_{th}	[mm]	12	12	12	12
Minimum screw-in depth	L_{sdmin}	[mm]	6	8	10	12
Minimum thickness of member	$h_{min,1}$	[mm]	80			
Minimum spacing	s_{min}	[mm]	30	70	70	100
Minimum edge distance	c_{min}	[mm]	60	100	100	130
Standard thickness of member	$h_{min,2}$	[mm]	100			
Minimum spacing	s_{min}	[mm]	30	50	60	100
Minimum edge distance	c_{min}	[mm]	60	100	100	110
Installation in precast pre-stressed hollow core slabs C30/37 to C50/60						
Spacing	s_{min}	[mm]	200			
Edge distance	c_{min}	[mm]	150			

Drop-in Anchor E / ES

 Intended use
 Installation parameters

Annex B3

Admissible anchor positions in precast pre-stressed hollow core slabs ($w / e \leq 4,2$)

Core distance:
 $l_c \geq 100 \text{ mm}$

Pre-stressing steel distance:
 $l_p \geq 100 \text{ mm}$

Distance between anchor position and pre-stressing steel:
 $a_p \geq 50 \text{ mm}$

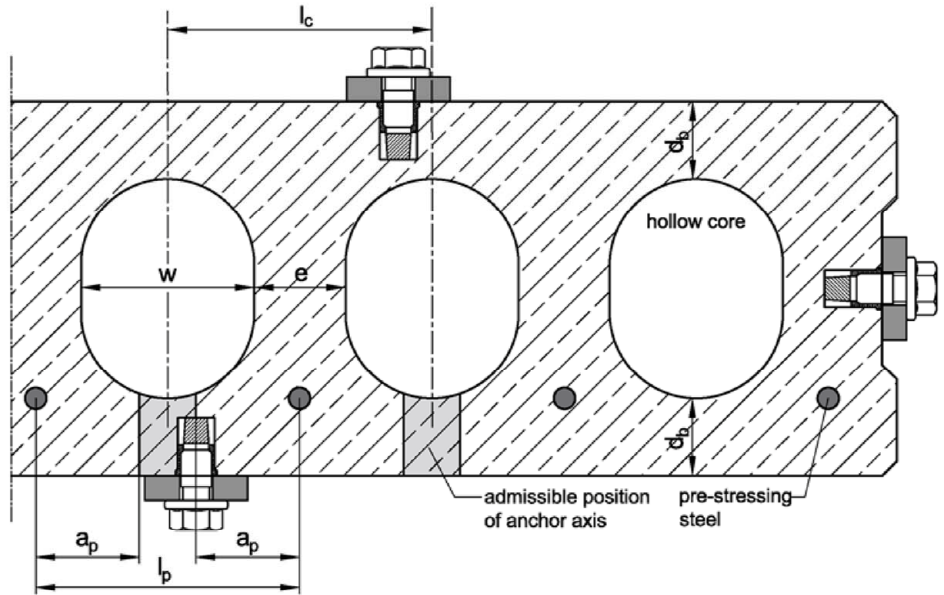

Minimum spacing and edge distance of anchors and distance in precast pre-stressed hollow core slabs

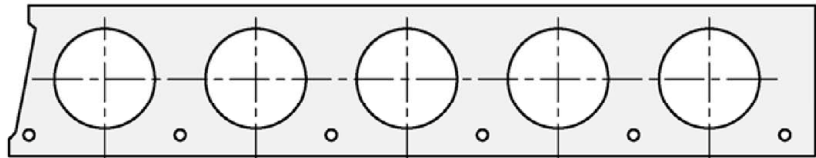

Minimum edge distance
 $c_{min} \geq 150 \text{ mm}$

Minimum spacing
 $s_{min} \geq 200 \text{ mm}$

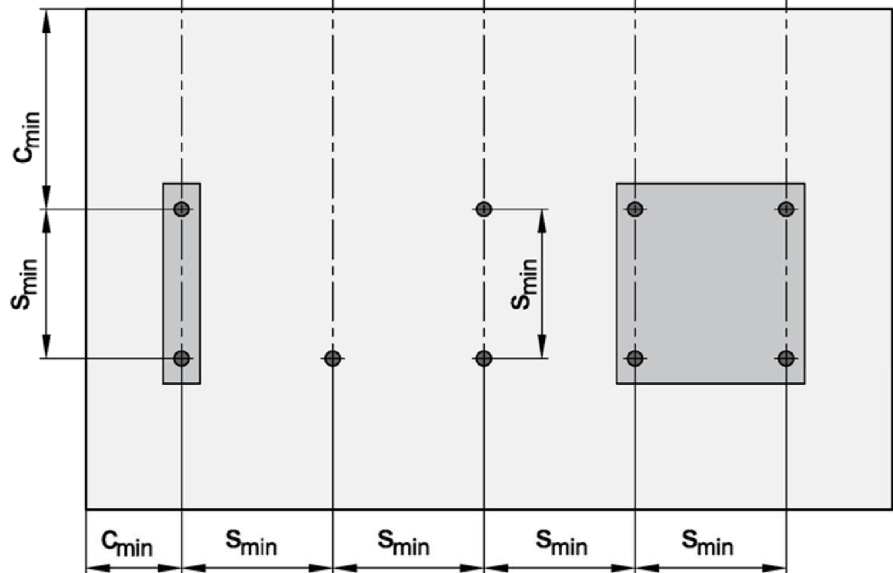

Drop-in Anchor E / ES

Intended use
 Installation in precast pre-stressed hollow core slabs

Annex B4

Installation instructions for solid concrete slabs

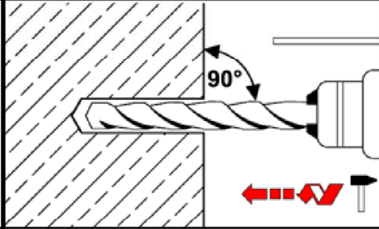
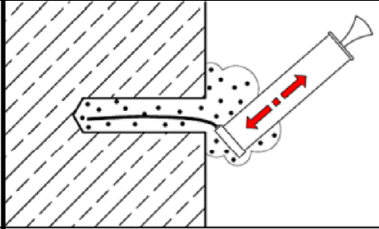
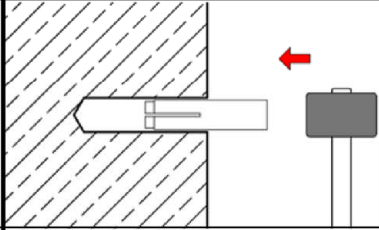
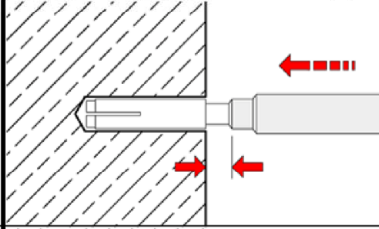
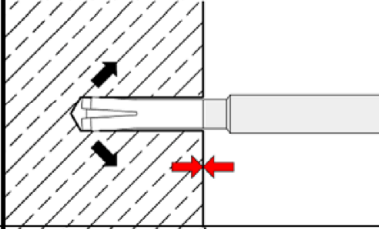
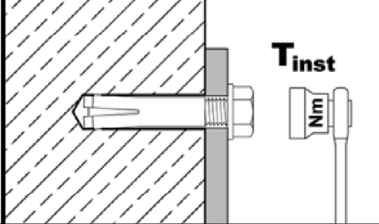
1		<p>Drill hole perpendicular to concrete surface. Using vacuum drill bit proceed with step 3.</p>
2		<p>Blow out dust. Alternatively, vacuum clean down to the bottom of the hole.</p>
3		<p>Drive in anchor.</p>
4		<p>Drive in cone by using setting tool.</p>
5		<p>Shoulder of setting tool must fit on anchor rim.</p>
6		<p>Turn in screw or threaded rod with nut, observe minimum screw-in depth (see Annex B3). Apply installation torque T_{inst}.</p>

Drop-in Anchor E / ES

Intended use
Installation instructions for solid concrete slabs

Annex B5

Installation instructions for precast pre-stressed hollow core slabs

1		Search for the position of the reinforcement.
2		Mark the position of the pre-stressing steel and search for the other position of the pre-stressing steel.
3		Mark the positions of next pre-stressing steel.
4		Drill hole while maintaining the required distances.
5		Blow out dust. Alternatively vacuum clean down to the bottom of the hole.
6		Drive in anchor.
7		Drive in cone by using setting tool.
8		Shoulder of setting tool must fit on anchor rim.
9		Turn in screw or threaded rod with nut, observe the minimum screw-in depth (see Annex B3). Apply installation torque T_{inst} .

Drop-in Anchor E / ES

Intended use
Installation instructions for precast pre-stressed hollow core slabs

Annex B6

Table C1: Characteristic resistance for $h_{ef} \geq 30$ mm in solid concrete slabs

Anchor size			M6x30	M8x30	M8x40	M10x30	M10x40	M12x50	M16x65
Installation factor	γ_{inst}	[-]	1,0						
Load in any direction									
Characteristic resistance in concrete C20/25 to C50/60	F_{Rk}^0	[kN]	3	5	6	6	6	6	16
Partial factor	$\gamma_M^{1)}$	[-]	1,8	2,16		2,1	2,16	1,8	1,8
Spacing	s_{cr}	[mm]	130	180	210	230	170	170	400
Edge distance	c_{cr}	[mm]	65	90	105	115	85	85	200
Shear load with lever arm, steel zinc plated									
Characteristic resistance (Steel 4.6)	$M_{Rk,s}^0$	[Nm]	6,1	15	15	30	30	52	133
Partial factor	$\gamma_{Ms}^{1)}$	[-]	1,67						
Characteristic resistance (Steel 4.8)	$M_{Rk,s}^0$	[Nm]	6,1	15	15	30	30	52	133
Partial factor	$\gamma_{Ms}^{1)}$	[-]	1,25						
Characteristic resistance (Steel 5.6)	$M_{Rk,s}^0$	[Nm]	7,6	19	19	37	37	65	166
Partial factor	$\gamma_{Ms}^{1)}$	[-]	1,67						
Characteristic resistance (Steel 5.8)	$M_{Rk,s}^0$	[Nm]	7,6	19	19	37	37	65	166
Partial factor	$\gamma_{Ms}^{1)}$	[-]	1,25						
Characteristic resistance (Steel 8.8)	$M_{Rk,s}^0$	[Nm]	12	30	30	59	60	105	266
Partial factor	$\gamma_{Ms}^{1)}$	[-]	1,25						
Shear load with lever arm, stainless steel A4 / HCR									
Characteristic resistance (Property class 70)	$M_{Rk,s}^0$	[Nm]	11	26	26	- ²⁾	52	92	233
Partial factor	$\gamma_{Ms}^{1)}$	[-]	1,56						
Characteristic resistance (Property class 80)	$M_{Rk,s}^0$	[Nm]	12	30	30	- ²⁾	60	105	266
Partial factor	$\gamma_{Ms}^{1)}$	[-]	1,33						

¹⁾ in absence of other national regulations

²⁾ Anchor version is not part of the ETA

Drop-in Anchor E / ES

Performance
Characteristic resistance for $h_{ef} \geq 30$ mm in **solid concrete**

Annex C1

Table C2: Characteristic resistance for $h_{ef} = 25$ mm in solid concrete slabs

Anchor size			M6x25	M8x25	M10x25	M12x25
Installation factor	γ_{inst}	[-]	1,0			
Load in any direction						
Characteristic resistance in concrete C12/15 and C16/20	F_{RK}^0	[kN]	2,5	2,5	3,5	3,5
Characteristic resistance in concrete C20/25 to C50/60	F_{RK}^0	[kN]	3,5	4,0	4,5	4,5
Partial factor	$\gamma_M^{1)}$	[-]	1,5			
Spacing	s_{cr}	[mm]	75	75	75	75
Edge distance	c_{cr}	[mm]	38	38	38	38
Shear load with lever arm						
Characteristic resistance (Steel 4.6)	$M_{RK,s}^0$	[Nm]	6,1	15	30	52
Partial factor	$\gamma_{Ms}^{1)}$	[-]	1,67			
Characteristic resistance (Steel 4.8)	$M_{RK,s}^0$	[Nm]	6,1	15	30	52
Partial factor	$\gamma_{Ms}^{1)}$	[-]	1,25			
Characteristic resistance (Steel 5.6)	$M_{RK,s}^0$	[Nm]	7,6	19	37	65
Partial factor	$\gamma_{Ms}^{1)}$	[-]	1,67			
Characteristic resistance (Steel 5.8)	$M_{RK,s}^0$	[Nm]	7,6	19	37	65
Partial factor	$\gamma_{Ms}^{1)}$	[-]	1,25			
Characteristic resistance (Steel 8.8)	$M_{RK,s}^0$	[Nm]	12	30	60	105
Partial factor	$\gamma_{Ms}^{1)}$	[-]	1,25			

¹⁾ in absence of other national regulations

Drop-in Anchor E / ES

Performance
Characteristic resistance for $h_{ef} = 25$ mm in solid concrete

Annex C2

Table C3: Characteristic resistance for $h_{ef} = 25$ mm in precast pre-stressed hollow core slabs

Anchor size			M6x25	M8x25	M10x25	M12x25
Installation factor	γ_{inst}	[-]	1,0			
Load in any direction						
Flange thickness	d_b	[mm]	≥ 35 (30) ¹⁾			
Characteristic resistance in precast pre-stressed hollow core slabs C30/37 to C50/60	F^{0}_{RK}	[kN]	3,5	4,0	4,5	4,5
Partial factor	$\gamma_{M^2)}$	[-]	1,5			
Spacing	s_{cr}	[mm]	200			
Edge distance	c_{cr}	[mm]	150			
Shear load with lever arm						
Characteristic resistance (Steel 4.6)	$M^{0}_{RK,s}$	[Nm]	6,1	15	30	52
Partial factor	$\gamma_{Ms^2)}$	[-]	1,67			
Characteristic resistance (Steel 4.8)	$M^{0}_{RK,s}$	[Nm]	6,1	15	30	52
Partial factor	$\gamma_{Ms^2)}$	[-]	1,25			
Characteristic resistance (Steel 5.6)	$M^{0}_{RK,s}$	[Nm]	7,6	19	37	65
Partial factor	$\gamma_{Ms^2)}$	[-]	1,67			
Characteristic resistance (Steel 5.8)	$M^{0}_{RK,s}$	[Nm]	7,6	19	37	65
Partial factor	$\gamma_{Ms^2)}$	[-]	1,25			
Characteristic resistance (Steel 8.8)	$M^{0}_{RK,s}$	[Nm]	12	30	60	105
Partial factor	$\gamma_{Ms^2)}$	[-]	1,25			

¹⁾ the anchor may be set in a flange thickness of 30 mm with identical characteristic loads, if the borehole cuts no hollow core

²⁾ in absence of other national regulations

Drop-in Anchor E / ES

Performance

Characteristic resistance for $h_{ef} = 25$ mm in **precast pre-stressed hollow core slabs**

Annex C3

**Table C4: Characteristic values under fire exposure in solid concrete slabs
C20/25 to C50/60 for $h_{ef} \geq 30$ mm**

Anchor size				M6x30	M8x30	M8x40	M10x30	M10x40	M12x50	M16x65	
Fire resistance class		Load in any direction									
Steel 4.6	R 30	Characteristic resistance	$F^{0}_{Rk,fi}$	[kN]	0,4	0,6	0,6	0,9	0,9	1,5	3,1
	R 60			[kN]	0,35	0,6	0,6	0,8	0,8	1,3	2,4
	R 90			[kN]	0,3	0,6	0,6	0,6	0,6	1,1	2,0
	R 120			[kN]	0,25	0,5	0,5	0,5	0,5	0,8	1,6
Steel 4.8	R 30	Characteristic resistance	$F^{0}_{Rk,fi}$	[kN]	0,4	0,9	1,1	0,9	1,5	1,5	4,0
	R 60			[kN]	0,35	0,9	0,9	0,9	1,5	1,5	4,0
	R 90			[kN]	0,3	0,6	0,6	0,9	1,1	1,5	3,0
	R 120			[kN]	0,3	0,5	0,5	0,7	0,9	1,2	2,4
Steel ≥ 5.6	R 30	Characteristic resistance	$F^{0}_{Rk,fi}$	[kN]	0,8	0,9	1,5	0,9	1,5	1,5	4,0
	R 60			[kN]	0,8	0,9	1,5	0,9	1,5	1,5	4,0
	R 90			[kN]	0,4	0,9	0,9	0,9	1,5	1,5	3,7
	R 120			[kN]	0,3	0,5	0,5	0,7	1,0	1,2	2,4
A4 / HCR	R 30	Characteristic resistance	$F^{0}_{Rk,fi}$	[kN]	0,8	0,9	1,5	⁻¹⁾	1,5	1,5	4,0
	R 60			[kN]	0,8	0,9	1,5	⁻¹⁾	1,5	1,5	4,0
	R 90			[kN]	0,4	0,9	0,9	⁻¹⁾	1,5	1,5	3,7
	R 120			[kN]	0,3	0,5	0,5	⁻¹⁾	1,0	1,2	2,4
Partial factor			$\gamma_{M,fi}$	[-]	1,0						
Steel zinc plated											
		Spacing	$S_{cr,fi}$	[mm]	130	180	210	170	170	200	400
R 30 – R 120		Edge distance	$C_{cr,fi}$	[mm]	65	90	105	85	85	100	200
If the fire attack is from more than one side, the edge distance shall be ≥ 300 mm.											
Stainless steel A4, HCR											
		Spacing	$S_{cr,fi}$	[mm]	130	180	210	⁻¹⁾	170	200	400
R 30 – R 120		Edge distance	$C_{cr,fi}$	[mm]	65	90	105	⁻¹⁾	85	100	200
If the fire attack is from more than one side, the edge distance shall be ≥ 300 mm.											

¹⁾ Anchor version is not part of the ETA

Drop-in Anchor E / ES

Performance
Characteristic values under **fire exposure** for $h_{ef} \geq 30$ mm

Annex C4

**Table C5: Characteristic values under fire exposure in solid concrete slabs
C20/25 to C50/60 for $h_{ef} = 25 \text{ mm}$**

Anchor size				M6x25	M8x25	M10x25	M12x25		
Fire resistance class		Load in any direction							
Steel ≥ 4.6	R 30	Characteristic resistance	$F^{0}_{RK,fi}$	[kN]	0,4	0,6	0,6	0,6	
	R 60			[kN]	0,35	0,6	0,6	0,6	
	R 90			[kN]	0,3	0,6	0,6	0,6	
	R 120			[kN]	0,25	0,5	0,5	0,5	
Partial factor			$\gamma_{M,fi}$	[-]				1,0	
Spacing			$s_{cr,fi}$	[mm]	100	100	100	100	
R 30 – R 120			Edge distance	$c_{cr,fi}$	[mm]	50	50	50	50
If the fire attack is from more than one side, the edge distance shall be $\geq 300 \text{ mm}$.									

Drop-in Anchor E / ES

Performance
Characteristic values under **fire exposure** for $h_{ef} = 25 \text{ mm}$

Annex C5