



...eine starke Verbindung

## IZJAVA O SVOJSTVIMA

DoP Br. MKT-1.1-500\_hr

- ✧ **Jedinstvena identifikacijska oznaka vrste proizvoda:** Sidro visokog opterećenja SL
- ✧ **Namjena/namjene:** Moment kontrolom sidro ekspanzija od pocinčanog čelika u veličini M10 za sidrenje u betonu uncracked, vidi Prilog/Annex B
- ✧ **Proizvođač:** MKT Metall-Kunststoff-Technik GmbH & Co.KG  
Auf dem Immel 2  
67685 Weilerbach
- ✧ **Sustav/sustavi za ocjenu i provjeru stalnosti svojstava (AVCP):** 1
- ✧ **Europski dokument za ocjenjivanje:** EAD 330232-00-0601  
Europska tehnička ocjena: ETA-08/0230, 14.05.2018  
Tijelo za tehničko ocjenjivanje: DIBt, Berlin  
Prijavljeno tijelo/prijavljena tijela: NB 2873 – Technische Universität Darmstadt
- ✧ **Objavljena svojstva:**

Bitnih značajka	Svojstva
<b>TEMELJNI ZAHTJEVI ZA GRAĐEVINE (BWR 1)</b>	
Karakteristični otpori za statičke i kvazistatičke opterećenja, Pomaci	Prilog/Annex C1 – C2
Karakteristični otpori za seizmičke performanse kategorije C1 + C2, Pomaci	NPD (No Performance Determined) bez utvrđenog svojstva
<b>Sigurnost u slučaju požara (BWR 2)</b>	
Ponašanje požara	Klasa A1
Otpornost na vatru	NPD (No Performance Determined) bez utvrđenog svojstva

Prije utvrđeno svojstvo proizvoda u skladu je s objavljenim svojstvima. Ova izjava o svojstvima izdaje se, u skladu s Uredbom (EU) br. 305/2011, pod isključivom odgovornošću prethodno utvrđenog proizvođača.

Za proizvođača i u njegovo ime potpisao:

  
**Stefan Weustenhagen**  
(generalni direktor)  
Weilerbach, 01.01.2021

p.p.   
**Dipl.-Ing. Detlef Bigalke**  
(Voditelj razvoja proizvoda)



Izvornik ove izjave o izvedbi pisan je na njemačkom jeziku. U slučaju odstupanja u prijevodu vrijedi njemačka verzija.

## Specifications of intended use

### Anchorage subject to:

- Static or quasi-static action

### Base materials:

- Reinforced or unreinforced normal weight concrete without fibres of strength classes C20/25 to C50/60 according to EN 206:2013
- Uncracked concrete

### Use conditions (Environmental conditions):

- Structures subject to dry internal conditions (zinc plated steel).

### Design:

- Anchorages are designed under the responsibility of an engineer experienced in anchorages and concrete work.
- Verifiable calculation notes and drawings are prepared taking account of the loads to be anchored. The position of the anchor is indicated on the design drawings (e.g. position of the anchor relative to reinforcement or to supports, etc.).
- Anchorages are designed according to FprEN 1992-4: 2016 and EOTA Technical Report TR 055.

### Installation:

- Anchor installation carried out by appropriately qualified personnel and under the supervision of the person responsible for technical matters of the site.
- Positioning of the drill holes without damaging the reinforcement
- In case of aborted hole: new drilling at a minimum distance away of twice the depth of the aborted hole or smaller distance if the aborted drill hole is filled with high strength mortar and if under shear or oblique tension load it is not in the direction of load application.
- Anchor installation such that the effective anchorage depth is complied with. This compliance is ensured, when the embedment mark of the anchor does no more exceed the concrete surface
- Drilling by hammer drill bit (use of vacuum drill bit is admissible)

## Highload Anchor SL

Intended use  
Specifications

Annex B1

## Installation instructions

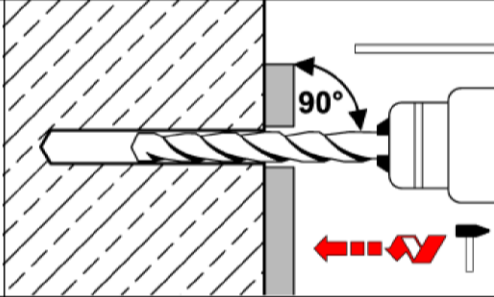
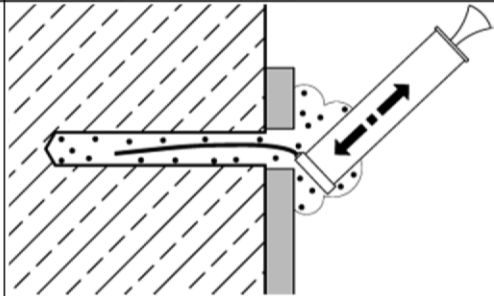
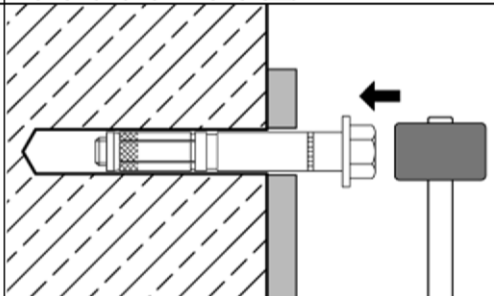
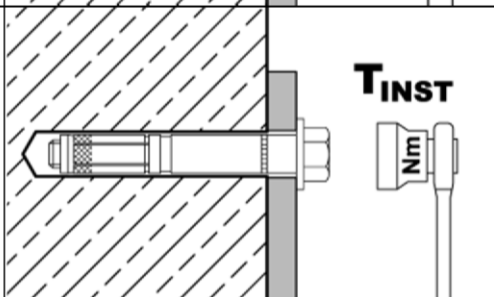
1		<p>Drill hole perpendicular to concrete surface. Using a vacuum drill bit, proceed with step 3.</p>
2		<p>Blow out dust. Alternatively vacuum clean down to the bottom of the hole.</p>
3		<p>Drive in anchor.</p>
4		<p>Apply tightening torque <math>T_{inst}</math> by using torque wrench.</p>

### Highload Anchor SL

Intended use  
Installation instructions

Annex B2

**Table B1: Installation parameters**

Anchor size			14/M10
Size of thread			M10
Effective anchorage depth	$h_{ef}$	[mm]	65
Nominal diameter of drill bit	$d_0$	[mm]	14
Cutting diameter of drill bit	$d_{cut} \leq$	[mm]	14,5
Depth of drill hole	$h_1 \geq$	[mm]	85
Diameter of clearance hole in the fixture mounted on distance sleeve	$d_f \leq$	[mm]	16
Diameter of clearance hole in the fixture mounted on threaded bolt	$d_f \leq$	[mm]	12
Installation torque	$T_{inst}$	[Nm]	50
Minimum thickness of member	$h_{min}$	[mm]	130
Minimum spacing	$s_{min}$	[mm]	60
Minimum edge distance	$c_{min}$	[mm]	120

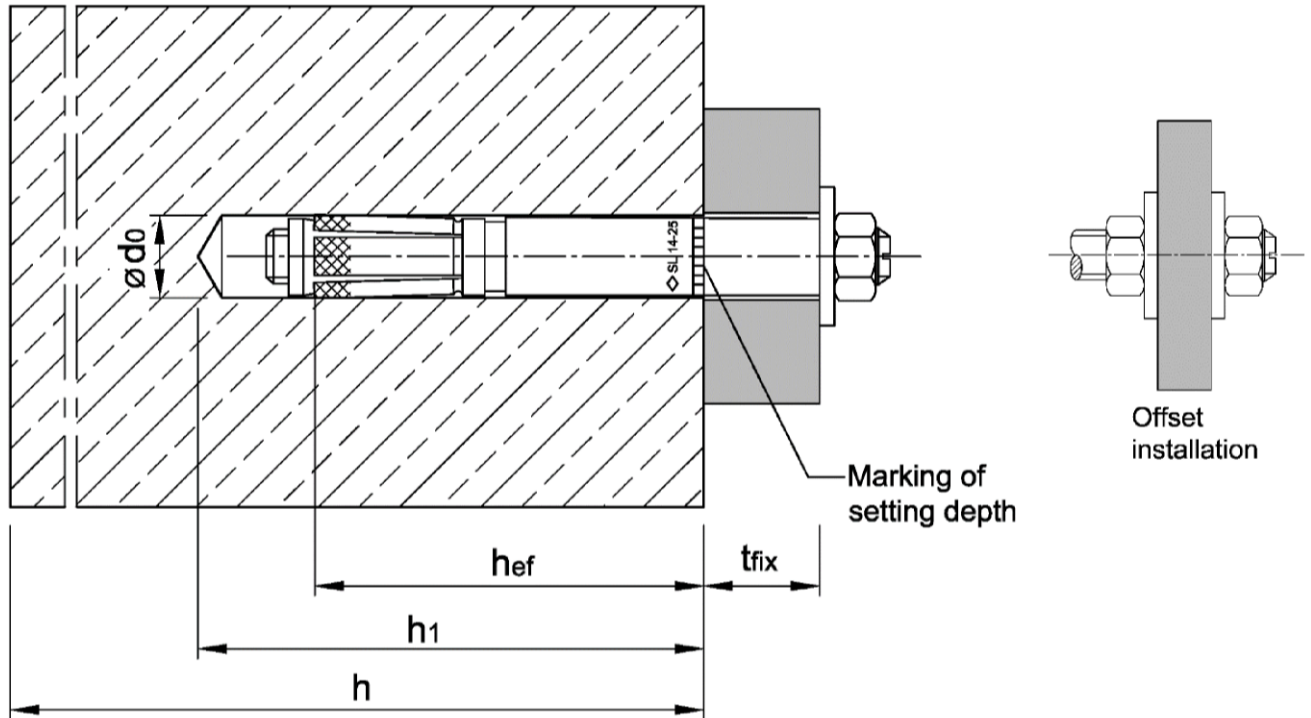

**Highload Anchor SL**

Intended use  
Installation parameters

**Annex B3**

**Table C1: Characteristic values for tension loads**

<b>Anchor size</b>			<b>14/M10</b>
Installation factor	$\gamma_{inst}$	[-]	1,0
<b>Steel failure</b>			
Characteristic resistance	$N_{Rk,s}$	[kN]	46
Partial factor	$\gamma_{Ms}$	[-]	1,5
<b>Pull-out failure</b>			
Characteristic resistance in uncracked concrete C20/25	$N_{Rk,p}$	[kN]	20
Increasing factor for $N_{Rk,p}$	$\psi_C$	[-]	$\left(\frac{f_{ck}}{20}\right)^{0,5}$
<b>Concrete cone failure</b>			
Effective Anchorage depth	$h_{ef}$	[mm]	65
Spacing	$s_{cr,N}$	[mm]	3 $h_{ef}$
Edge distance	$c_{cr,N}$	[mm]	1,5 $h_{ef}$
Factor $k_1$	$k_{ucr,N}$	[-]	11,0
<b>Splitting failure</b>			
Characteristic resistance in uncracked concrete	$N^0_{Rk,sp}$	[kN]	min [ $N_{Rk,p}; N^0_{Rk,c}$ ]
Spacing	$s_{cr,sp}$	[mm]	6 $h_{ef}$
Edge distance	$c_{cr,sp}$	[mm]	3 $h_{ef}$

**Table C2: Displacements under tension loads**

<b>Anchor size</b>			<b>14/M10</b>
Tension load in uncracked concrete	N	[kN]	9,5
Displacement	$\delta_{N0}$	[mm]	0,3
	$\delta_{N\infty}$	[mm]	0,6

**Highload Anchor SL**

**Performance**  
Characteristic values and displacements under **tension load**

**Annex C1**

**Table C3: Characteristic values for shear loads**

Anchor size			14/M10
<b>Steel failure without lever arm</b>			
Characteristic resistance, fixture mounted on distance sleeve with $t_{fix} \leq 75$ mm	$V^0_{Rk,s}$	[kN]	32,8
Characteristic resistance, fixture mounted on distance sleeve with $t_{fix} > 75$ mm	$V^0_{Rk,s}$	[kN]	23,2
Factor	$k_7$	[-]	1,0
Partial factor	$\gamma_{Ms}$	[-]	1,25
<b>Steel failure with lever arm</b>			
Characteristic resistance	$M^0_{Rk,s}$	[Nm]	60
Partial factor	$\gamma_{Ms}$	[-]	1,25
<b>Concrete pry-out failure</b>			
Factor	$k_8$	[-]	2,0
<b>Concrete edge failure</b>			
Effective length of anchor in shear loading	$l_f$	[mm]	65
Outside diameter of anchor	$d_{nom}$	[mm]	14

**Table C4: Displacements under shear loads**

Anchor size			14/M10
Shear load in uncracked concrete	$V$	[kN]	13,2
Displacement	$\delta_{v0}$	[mm]	2,2
	$\delta_{v\infty}$	[mm]	3,3

**Highload Anchor SL**

**Performance**  
 Characteristic values and displacements under **shear load**

**Annex C2**