

PRESTANDEKLARATION

DoP Nr: **MKT-1.1-500_sv**

- ◇ **Produkttypens unika identifikationskod:** **Tung lastankare SL**
- ◇ **Avsedd användning/avsedda användningar:** Momentstyrt expanderbultar av galvaniserat stål av storlek M10 för användning i orackad betong, se bilaga/Annex B
- ◇ **Tillverkare:** MKT Metall-Kunststoff-Technik GmbH & Co.KG
Auf dem Immel 2
67685 Weilerbach
- ◇ **System för bedömning och fortlöpande kontroll av prestanda:** 1
- ◇ **Europeiskt bedömningsdokument:** **EAD 330232-00-0601**
Europeisk teknisk bedömning: **ETA-08/0230, 14.05.2018**
Tekniskt bedömningsorgan: DIBt, Berlin
Anmält/anmälda organ: NB 2873 – Technische Universität Darmstadt
- ◇ **Angiven prestanda:**

Väsentliga egenskaper	Prestanda
Bärförmåga, stadga och beständighet (BWR 1)	
Karakteristiska resistanser för statiska och kvasi-statiska belastningar, Skift	Bilaga/Annex C1 – C2
Karakteristiska motstånd för de seismiska prestandakategorierna C1 + C2, Skift	NPD (No Performance Determined) ingen prestanda fastställd
Säkerhet vid brand (BWR 2)	
Brandegenskaper	Klass A1
Brandmotstånd	NPD (No Performance Determined) ingen prestanda fastställd

Prestandan för ovanstående produkt överensstämmer med den angivna prestandan. Denna prestandadeklaration har utfärdats i enlighet med förordning (EU) nr 305/2011 på eget ansvar av den tillverkare som anges ovan.

Undertecknad på tillverkarens vägnar av:

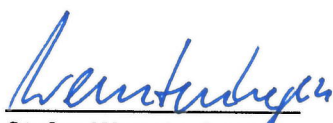

Stefan Weustenhagen
(Verkställande direktör)
Weilerbach, 01.01.2021

p.p.

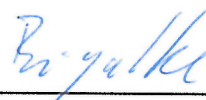

Dipl.-Ing. Detlef Bigalke
(Produktutveckling direktör)



Originalen av denna deklaraionsförklaring skrevs på tyska. Vid avvikelser i översättningen gäller den tyska versionen.

Specifications of intended use

Anchorage subject to:

- Static or quasi-static action

Base materials:

- Reinforced or unreinforced normal weight concrete without fibres of strength classes C20/25 to C50/60 according to EN 206:2013
- Uncracked concrete

Use conditions (Environmental conditions):

- Structures subject to dry internal conditions (zinc plated steel).

Design:

- Anchorages are designed under the responsibility of an engineer experienced in anchorages and concrete work.
- Verifiable calculation notes and drawings are prepared taking account of the loads to be anchored. The position of the anchor is indicated on the design drawings (e.g. position of the anchor relative to reinforcement or to supports, etc.).
- Anchorages are designed according to FprEN 1992-4: 2016 and EOTA Technical Report TR 055.

Installation:

- Anchor installation carried out by appropriately qualified personnel and under the supervision of the person responsible for technical matters of the site.
- Positioning of the drill holes without damaging the reinforcement
- In case of aborted hole: new drilling at a minimum distance away of twice the depth of the aborted hole or smaller distance if the aborted drill hole is filled with high strength mortar and if under shear or oblique tension load it is not in the direction of load application.
- Anchor installation such that the effective anchorage depth is complied with. This compliance is ensured, when the embedment mark of the anchor does no more exceed the concrete surface
- Drilling by hammer drill bit (use of vacuum drill bit is admissible)

Highload Anchor SL

Intended use
Specifications

Annex B1

Installation instructions

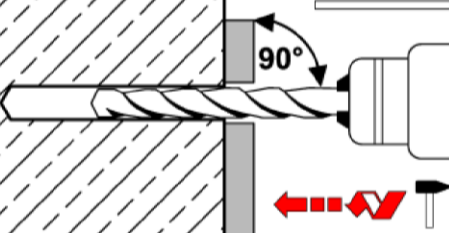
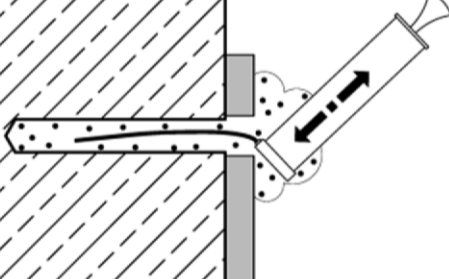
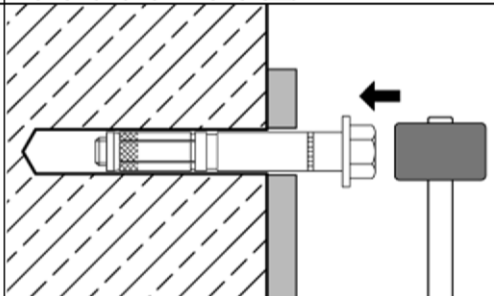
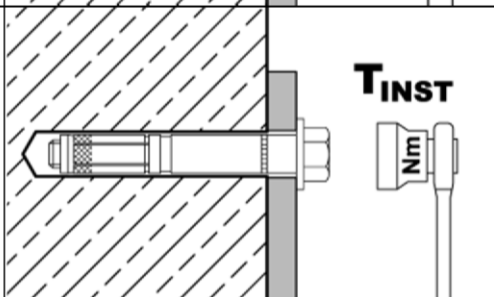
1		<p>Drill hole perpendicular to concrete surface. Using a vacuum drill bit, proceed with step 3.</p>
2		<p>Blow out dust. Alternatively vacuum clean down to the bottom of the hole.</p>
3		<p>Drive in anchor.</p>
4		<p>Apply tightening torque T_{inst} by using torque wrench.</p>

Highload Anchor SL

Intended use
Installation instructions

Annex B2

Table B1: Installation parameters

Anchor size			14/M10
Size of thread			M10
Effective anchorage depth	h_{ef}	[mm]	65
Nominal diameter of drill bit	d_0	[mm]	14
Cutting diameter of drill bit	$d_{cut} \leq$	[mm]	14,5
Depth of drill hole	$h_1 \geq$	[mm]	85
Diameter of clearance hole in the fixture mounted on distance sleeve	$d_f \leq$	[mm]	16
Diameter of clearance hole in the fixture mounted on threaded bolt	$d_f \leq$	[mm]	12
Installation torque	T_{inst}	[Nm]	50
Minimum thickness of member	h_{min}	[mm]	130
Minimum spacing	s_{min}	[mm]	60
Minimum edge distance	c_{min}	[mm]	120

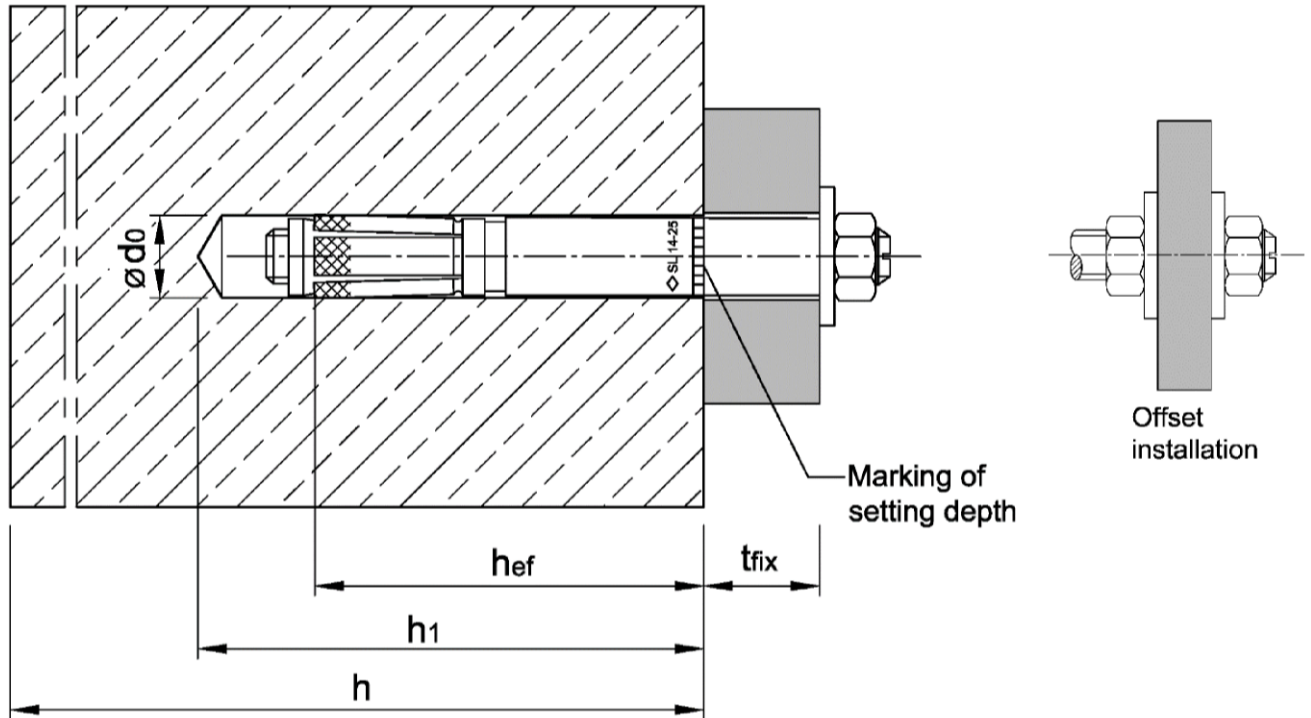

Highload Anchor SL

Intended use
Installation parameters

Annex B3

Table C1: Characteristic values for tension loads

Anchor size			14/M10
Installation factor	γ_{inst}	[-]	1,0
Steel failure			
Characteristic resistance	$N_{Rk,s}$	[kN]	46
Partial factor	γ_{Ms}	[-]	1,5
Pull-out failure			
Characteristic resistance in uncracked concrete C20/25	$N_{Rk,p}$	[kN]	20
Increasing factor for $N_{Rk,p}$	ψ_C	[-]	$\left(\frac{f_{ck}}{20}\right)^{0,5}$
Concrete cone failure			
Effective Anchorage depth	h_{ef}	[mm]	65
Spacing	$s_{cr,N}$	[mm]	3 h_{ef}
Edge distance	$c_{cr,N}$	[mm]	1,5 h_{ef}
Factor k_1	$k_{ucr,N}$	[-]	11,0
Splitting failure			
Characteristic resistance in uncracked concrete	$N^0_{Rk,sp}$	[kN]	min [$N_{Rk,p}; N^0_{Rk,c}$]
Spacing	$s_{cr,sp}$	[mm]	6 h_{ef}
Edge distance	$c_{cr,sp}$	[mm]	3 h_{ef}

Table C2: Displacements under tension loads

Anchor size			14/M10
Tension load in uncracked concrete	N	[kN]	9,5
Displacement	δ_{N0}	[mm]	0,3
	$\delta_{N\infty}$	[mm]	0,6

Highload Anchor SL
Performance
 Characteristic values and displacements under **tension load**
Annex C1

Table C3: Characteristic values for shear loads

Anchor size			14/M10
Steel failure without lever arm			
Characteristic resistance, fixture mounted on distance sleeve with $t_{fix} \leq 75$ mm	$V^0_{Rk,s}$	[kN]	32,8
Characteristic resistance, fixture mounted on distance sleeve with $t_{fix} > 75$ mm	$V^0_{Rk,s}$	[kN]	23,2
Factor	k_7	[-]	1,0
Partial factor	γ_{Ms}	[-]	1,25
Steel failure with lever arm			
Characteristic resistance	$M^0_{Rk,s}$	[Nm]	60
Partial factor	γ_{Ms}	[-]	1,25
Concrete pry-out failure			
Factor	k_8	[-]	2,0
Concrete edge failure			
Effective length of anchor in shear loading	l_f	[mm]	65
Outside diameter of anchor	d_{nom}	[mm]	14

Table C4: Displacements under shear loads

Anchor size			14/M10
Shear load in uncracked concrete	V	[kN]	13,2
Displacement	δ_{v0}	[mm]	2,2
	$\delta_{v\infty}$	[mm]	3,3

Highload Anchor SL

Performance
 Characteristic values and displacements under **shear load**

Annex C2