



... eine starke Verbindung

## ДЕКЛАРАЦИЯ ЗА ЕКСПЛОАТАЦИОННИ ПОКАЗАТЕЛИ

DoP № MKT-2.2-100\_bg

- ❖ **Уникален идентификационен код на типа продукт:** инжекционна система VMU plus за зидария
- ❖ **Предвидена употреба/употреби:** Инжекционна система за закрепване в зидария, виж Приложение Б/Annex B
- ❖ **Производител:** MKT Metall-Kunststoff-Technik GmbH & Co.KG  
Auf dem Immel 2  
67685 Weilerbach
- ❖ **Система или системи за оценяване и проверка на постоянството на експлоатационните показатели:** 1
- ❖ **Европейски документ за оценяване:** ETAG 029  
Европейска техническа оценка: ETA-13/0909, 08.12.2016  
Орган за техническа оценка: DIBt, Berlin  
отифициран орган/органи: NB 2873 – Technische Universität Darmstadt

❖ **Декларирани експлоатационни показатели:**

Съществени характеристики	Експлоатационни показатели
<b>Механично съпротивление и устойчивост (BWR 1)</b>	
Коефициент на редукция за тестове на строителната площадка ( $\beta$ фактор)	виж приложение / Annex C1
Характерна носеща способност на стоманените елементи	виж приложение / Annex C2
Характерна носеща способност на дюбелите в зидарията	виж приложение / Annex C3 – C45
Изместване (натоварване при опън и срязване)	виж приложение / Annex C4 – C45
Разстояния на ръба и центъра	виж приложение / Annex C3 – C45
Групов фактор за групови закрепвания	виж приложение / Annex C3 – C45
<b>Безопасност в случай на пожар (BWR 2)</b>	
на поведение при пожар	клас A1
пожароустойчивост	Производителността не е оценена

експлоатационните показатели на продукта, посочени по-горе, са в съответствие с декларираните експлоатационни показатели. Настоящата декларация за експлоатационни показатели се издава в съответствие с Регламент (ЕУ) № 305/2011, като отговорността за нея се носи изцяло от посочения по-горе производител.

Подписано за и от името на производителя от:

  
**Stefan Weustenhagen**

(Управител)

Weilerbach, 01.01.2021

р.р.   
**Dipl.-Ing. Detlef Bigalke**  
(Продуктов мениджър)



Оригиналът на тази декларация за експлоатационни показатели е на немски език. В случай на отклонения в превода, немската версия е валидна.

## Specifications of intended use

### Anchorage subject to:

- Static and quasi-static loads

### Base material:

- Autoclaved Aerated Concrete (use category d) according to Annex B2
- Solid brick masonry (use category b), according to Annex B2.
- Hollow brick masonry (use category c), according to Annex B2 and B3.
- Mortar strength class of the masonry M 2,5 at minimum according to EN 998-2:2010.
- For other bricks in solid masonry and in hollow or perforated masonry, the characteristic resistance of the anchor may be determined by job site tests according to ETAG 029, Annex B under consideration of the  $\beta$  factor according to Annex C1, Table C1

Note: The characteristic resistance for solid bricks and autoclaved aerated concrete are also valid for larger brick sizes and larger compressive strength of the masonry unit.

### Temperature range:

- $T_a$ : - 40°C to +40°C (max. short term temperature +40°C and max. long term temperature +24°C)
- $T_b$ : - 40°C to +80°C (max. short term temperature +80°C and max. long term temperature +50°C)
- $T_c$ : - 40°C to +120°C (max. short term temperature +120°C and max. long term temperature +72°C)

### Use conditions (Environmental conditions):

- Dry and wet structure (regarding injection mortar).
- Structures subject to dry internal conditions (zinc coated steel, stainless steel or high corrosion resistant steel).
- Structures subject to external atmospheric exposure (including industrial and marine environment) and to permanently damp internal condition, if no particular aggressive conditions exist (stainless steel or high corrosion resistant steel).
- Structures subject to external atmospheric exposure and to permanently damp internal condition, if other particular aggressive conditions exist (high corrosion resistant steel).

Note: Particular aggressive conditions are e.g. permanent, alternating immersion in seawater or the splash zone of seawater, chloride atmosphere of indoor swimming pools or atmosphere with extreme chemical pollution (e.g. in desulphurization plants or road tunnels where de-icing materials are used).

### Use categories in respect of installation and use:

- Category d/d: Installation and use in dry masonry
- Category w/d: Installation in wet masonry and use in dry masonry
- Category w/w: Installation and use in dry or wet masonry

### Design:

- Verifiable calculation notes and drawings are prepared taking account the relevant masonry in the region of the anchorage, the loads to be transmitted and their transmission to the supports of the structure. The position of the anchor is indicated on the design drawings.
- The anchorages are designed in accordance with the ETAG 029, Annex C, Design method A under the responsibility of an engineer experienced in anchorages and masonry work.

Characteristic values	$N_{RK,s}$ $V_{RK,s}$	$N_{RK,p} = N_{RK,b}$ $V_{RK,b}$ and $V_{RK,c}$	$N_{RK,pb}$ $V_{RK,pb}$
Determination acc. to	Annex C3	Annex C4 to C45	ETAG 029, Annex C

- For application with sleeve with drill bit size  $\leq 15$ mm installed in joints not filled with mortar:  
 $N_{RK,p,j} = 0,18 * N_{RK,p}$  and  $N_{RK,b,j} = 0,18 * N_{RK,b}$  ( $N_{RK,p} = N_{RK,b}$  see Annex C4 to C45)  
 $V_{RK,c,j} = 0,15 * V_{RK,c}$  and  $V_{RK,b,j} = 0,15 * V_{RK,b}$  ( $V_{RK,b}$  and  $V_{RK,c}$  see Annex C4 to C45)
- Application without sleeve installed in joints not filled with mortar is not allowed.

### Installation:





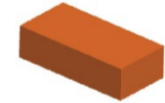
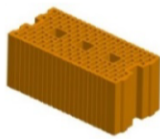
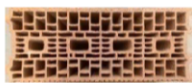
- Dry or wet structures
- Drill method acc. to Annex C4 to C45.
- Anchor Installation carried out by appropriately qualified personnel and under the supervision of the person responsible for technical matters of the site.
- When using anchor rods with internal thread (VMU-IG) fastening screws or threaded rods (incl. nut and washer) must comply with the appropriate material and property class of the Internal threaded rod.

## Injection System VMU plus for masonry

Intended Use  
Specifications

**Annex B1**

**Table B1: Overview brick types and properties with corresponding fastening elements (Anchor and sleeve)**

Brick-No.	Brick type	Picture	Brick size	Compressive strength	Bulk density	Sleeve - Anchor type	Annex
			length width height				
<b>Autoclaved aerated concrete units according EN 771-4</b>							
1	Autoclaved aerated concrete AAC6		499 240 249	6	0,6	M8/M10/M12/M16 IG-M6/IG-M8/IG-M10	C4 - C5
<b>Calcium silicate masonry units according EN 771-2</b>							
2	Calcium silicate solid brick KS-NF		240 115 71	10 20 27	2,0	M8/M10/M12/M16/IG-M6/IG-M8/IG-M10 VM-SH 12x80 – M8 VM-SH 16x85 – M8/M10/IG-M6 VM-SH 16x130 – M8/M10/IG-M6 VM-SH 20x85 – M12/M16/IG-M8/IG-M10 VM-SH 20x130 – M12/M16/IG-M8/IG-M10 VM-SH 20x200 – M12/M16/IG-M8/IG-M10	C6 - C8
3	Calcium silicate hollow brick KSL-3DF		240 175 113	8 12 14	1,4	VM-SH 12x80 – M8 VM-SH 16x85 – M8/M10/IG-M6 VM-SH 16x130 – M8/M10/IG-M6 VM-SH 20x85 – M12/M16/IG-M8/IG-M10 VM-SH 20x130 – M12/M16/IG-M8/IG-M10 VM-SH 20x200 – M12/M16/IG-M8/IG-M10	C9 - C11
4	Calcium silicate hollow brick KSL-12DF		498 175 238	10 12 16	1,4	VM-SH 12x80 – M8 VM-SH 16x85 – M8/M10/IG-M6 VM-SH 16x130 – M8/M10/IG-M6 VM-SH 20x85 – M12/M16/IG-M8/IG-M10 VM-SH 20x130 – M12/M16/IG-M8/IG-M10	C12 - C14
<b>Clay masonry units according EN 771-1</b>							
5	Clay solid brick Mz – DF		240 115 55	10 20 28	1,6	M8/M10/M12/M16/IG-M6/IG-M8/IG-M10 VM-SH 12x80 – M8 VM-SH 16x85 – M8/M10/IG-M6 VM-SH 16x130 – M8/M10/IG-M6 VM-SH 20x85 – M12/M16/IG-M8/IG-M10 VM-SH 20x130 – M12/M16/IG-M8/IG-M10 VM-SH 20x200 – M12/M16/IG-M8/IG-M10	C15 - C17
6	Clay hollow brick HLZ-16DF		497 240 238	6 8 12 14	0,8	VM-SH 12x80 – M8 VM-SH 16x85 – M8/M10/IG-M6 VM-SH 16x130 – M8/M10/IG-M6 VM-SH 20x85 – M12/M16/IG-M8/IG-M10 VM-SH 20x130 – M12/M16/IG-M8/IG-M10 VM-SH 20x200 – M12/M16/IG-M8/IG-M10	C18 - C20
7	Clay hollow brick Porotherm Homebric		500 200 299	4 6 10	0,7	VM-SH 12x80 – M8 VM-SH 16x85 – M8/M10/IG-M6 VM-SH 16x130 – M8/M10/IG-M6 VM-SH 20x85 – M12/M16/IG-M8/IG-M10 VM-SH 20x130 – M12/M16/IG-M8/IG-M10	C21 - C23









**Injection System VMU plus for masonry**

**Intended use**

Brick types and properties with corresponding fastening elements

**Annex B2**

**Table B1: Overview brick types and properties with corresponding fastening elements (Anchor and sleeve) – continue**

Brick-No.	Brick type	Picture	Brick size	Compressive strength	Bulk density	Sleeve - Anchor type	Annex
			length width height				
<b>Clay masonry units according EN 771-1</b>							
8	Clay hollow brick BGV Thermo		500 200 314	4 6 10	0,6	VM-SH 12x80 – M8 VM-SH 16x85 – M8/M10/IG-M6 VM-SH 16x130 – M8/M10/IG-M6 VM-SH 20x85 – M12/M16/IG-M8/IG-M10 VM-SH 20x130 – M12/M16/IG-M8/IG-M10	C24 - C26
9	Clay hollow brick Calibric R+		500 200 314	6 9 12	0,6	VM-SH 12x80 – M8 VM-SH 16x85 – M8/M10/IG-M6 VM-SH 16x130 – M8/M10/IG-M6 VM-SH 20x85 – M12/M16/IG-M8/IG-M10 VM-SH 20x130 – M12/M16/IG-M8/IG-M10	C27 - C29
10	Clay hollow brick Urbanbric		560 200 274	6 9 12	0,7	VM-SH 12x80 – M8 VM-SH 16x85 – M8/M10/IG-M6 VM-SH 16x130 – M8/M10/IG-M6 VM-SH 20x85 – M12/M16/IG-M8/IG-M10 VM-SH 20x130 – M12/M16/IG-M8/IG-M10	C30 - C32
11	Clay hollow brick Brique creuse C40		500 200 200	4 8 12	0,7	VM-SH 12x80 – M8 VM-SH 16x85 – M8/M10/IG-M6 VM-SH 16x130 – M8/M10/IG-M6 VM-SH 20x85 – M12/M16/IG-M8/IG-M10 VM-SH 20x130 – M12/M16/IG-M8/IG-M10	C33 - C35
12	Clay hollow brick Blocchi Leggeri		250 120 250	4 6 8 12	0,6	VM-SH 12x80 – M8 VM-SH 16x85 – M8/M10/IG-M6 VM-SH 16x130 – M8/M10/IG-M6 VM-SH 20x85 – M12/M16/IG-M8/IG-M10 VM-SH 20x130 – M12/M16/IG-M8/IG-M10 VM-SH 20x200 – M12/M16/IG-M8/IG-M10	C36 - C38
13	Clay hollow brick Doppio Uni		250 120 120	10 16 20 28	0,9	VM-SH 12x80 – M8 VM-SH 16x85 – M8/M10/IG-M6 VM-SH 16x130 – M8/M10/IG-M6 VM-SH 20x85 – M12/M16/IG-M8/IG-M10 VM-SH 20x130 – M12/M16/IG-M8/IG-M10 VM-SH 20x200 – M12/M16/IG-M8/IG-M10	C39 - C41
<b>Lightweight concrete according EN 771-3</b>							
14	Hollow lightweight concrete Bloc creux B40		494 200 190	4	0,8	VM-SH 12x80 – M8 VM-SH 16x85 – M8/M10/IG-M6 VM-SH 16x130 – M8/M10/IG-M6 VM-SH 20x85 – M12/M16/IG-M8/IG-M10 VM-SH 20x130 – M12/M16/IG-M8/IG-M10	C42 - C43
15	Solid lightweight concrete		300 123 248	2	0,6	M8/M10/M12/M16/IG-M6/IG-M8/IG-M10 VM-SH 12x80 – M8 VM-SH 16x85 – M8/M10/IG-M6 VM-SH 16x130 – M8/M10/IG-M6 VM-SH 20x85 – M12/M16/IG-M8/IG-M10 VM-SH 20x130 – M12/M16/IG-M8/IG-M10 VM-SH 20x200 – M12/M16/IG-M8/IG-M10	C44 - C45

**Injection System VMU plus for masonry**

**Intended use**

Brick types and properties with corresponding fastening elements

**Annex B3**

**Installation: Steel brush**



**Table B2: Installation parameters in autoclaved aerated concrete AAC and solid masonry (without sleeve)**

Anchor type and size		VMU-A M8 V-A M8	VMU-A M10 V-A M10	VMU-IG M6	VMU-A M12 V-A M12	VMU-IG M8	VMU-A M16 V-A M16	VMU-IG M10
		Nominal drill hole diameter	$d_0$ [mm]	10	12		14	
Drill hole depth	$h_0$ [mm]	80	90		100		100	
Effective anchorage depth	$h_{ef}$ [mm]	80	90		100		100	
Minimum wall thickness	$h_{min}$ [mm]	$h_{ef} + 30$						
Diameter of clearance hole in the fixture	$d_f \leq$ [mm]	9	12	7	14	9	18	12
Diameter of steel brush	$d_b$ [mm]	12	14		16		20	
Min. diameter of steel brush	$d_{b,min}$ [mm]	10,5	12,5		14,5		18,5	
Max. installation torque moment	$T_{inst,max}$ [Nm]	2 (14 for Mz DF)						

**Table B3: Installation parameters in solid and hollow masonry (with sleeve)**

Anchor size		M8	M8 / M10 / IG-M6		M12 / M16 IG-M8 IG-M10		
		12x80	16x85	16x130	20x85	20x130	20x200
Nominal drill hole diameter	$d_0$ [mm]	12	16		20		
Drill hole depth	$h_0$ [mm]	85	90	135	90	135	205
Effective anchorage depth	$h_{ef}$ [mm]	80	85	130	85	130	200
Minimum wall thickness	$h_{min}$ [mm]	115	115	175	115	175	240
Diameter of clearance hole in the fixture	$d_f \leq$ [mm]	9	7 (IG-M6) 9 (M8) 12 (M10)		9 (IG-M8) 12 (IG-M10) 14 (M12) 18 (M16)		
Diameter of steel brush	$d_b$ [mm]	14	18		22		
Min. diameter of steel brush	$d_{b,min}$ [mm]	12,5	16,5		20,5		
Max. installation torque moment	$T_{inst,max}$ [Nm]	2					

**Injection System VMU plus for masonry**

**Intended use**

Cleaning brush and installation parameters

**Annex B4**

**Table B4: Maximum working time and minimum curing time  
VMU plus**

Temperature in the base material	Temperature of cartridge	Working time	Minimum curing time in dry base material <sup>1)</sup>
-10 °C to - 6 °C	+ 15 °C to + 40 °C	90 min	24 h
- 5 °C to - 1 °C	+ 5 °C to + 40 °C	90 min	14 h
0 °C to + 4 °C		45 min	7 h
+ 5 °C to + 9 °C		25 min	2 h
+ 10 °C to + 19 °C		15 min	80 min
+ 20 °C to + 29 °C		6 min	45 min
+ 30 °C to + 34 °C		4 min	25 min
+ 35 °C to + 39 °C		2 min	20 min
+ 40 °C		1,5 min	15 min

<sup>1)</sup> In wet base material the curing time **must** be doubled.

**Table B5: Maximum working time and minimum curing time  
VMU plus Polar**

Temperature in the base material	Temperature of cartridge	Working time	Minimum curing time in dry base material <sup>1)</sup>
-20 °C to - 16 °C	-20 °C to +10 °C	75 min	24 h
- 15 °C to - 11 °C		55 min	16 h
- 10 °C to - 6 °C		35 min	10 h
- 5 °C to - 1 °C		20 min	5 h
0 °C to + 4 °C		10 min	2,5 h
+ 5 °C to + 9 °C		6 min	80 min
+ 10 °C		6 min	60 min

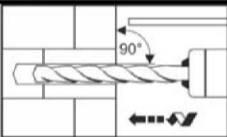
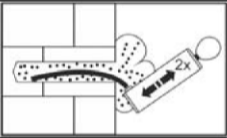
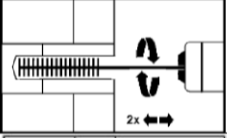
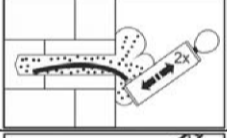
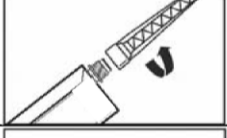
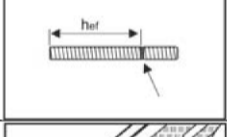
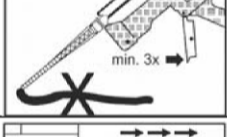
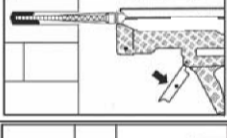
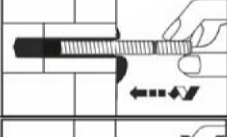
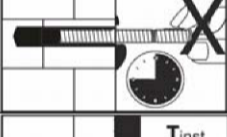
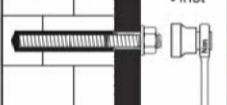
<sup>1)</sup> In wet base material the curing time **must** be doubled.

**Injection System VMU plus for masonry**

**Intended Use**  
Working and curing time

**Annex B5**

## Installation Instruction - Solid masonry without sleeve

1.		Drill hole perpendicular to the surface of base material with drill method according to Annex C4-C45, with nominal drill hole diameter and bore hole depth according to the size and embedment depth required by the selected anchor. In case of aborted drill hole the hole shall be filled with mortar.
2a.		<b>Drill hole must be cleaned prior to installation of the anchor.</b> Blow out from the bottom of the bore hole two times.
2b.		Attach the appropriate sized brush (acc.to Annex B4) to a drilling machine or a battery screwdriver, brush the hole clean two times.
2c.		Finally blow out the hole again two times.
3.		Remove the cap and attach the supplied static-mixing nozzle to the cartridge and load the cartridge into the correct dispensing tool. In case of a foil tube cartridge, cut off the clip before use. For every working interruption longer than the recommended working time (Table B4 or B5) as well as for new cartridges, a new static-mixer shall be used.
4.		The position of the embedment depth shall be marked on the threaded rod. The anchor rod shall be free of dirt, grease, oil or other foreign material.
5.		Initial adhesive is not suitable for fixing the anchor. Prior to dispensing into the anchor hole, squeeze out separately a minimum of three full strokes, for foil tube cartridges six full strokes and discard non-uniformly mixed adhesive components until the mortar shows a consistent grey color.
6.		Starting from the bottom or back of the cleaned anchor hole, fill up the hole to min two-thirds with adhesive. Slowly withdraw the static mixing nozzle will avoid creating air pockets. Observe the working times given in Table B4 and B5.
7.		Push the threaded rod into the anchor hole while turning slightly to ensure positive distribution of the adhesive until the embedment depth is reached. Be sure that the annular gap is fully filled with mortar. If no excess mortar is visible at the top of the hole, the application has to be renewed.
8.		Allow the adhesive to cure to the specified curing time given in Table B4 or B5. Do not move or load the anchor until it is fully cured. After curing time remove access mortar.
9.		After full curing, the fixture can be installed with up to the max. installation torque acc. to Table B2 or B3 with calibrated torque wrench.

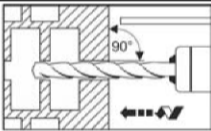
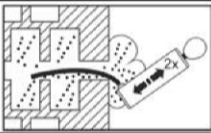
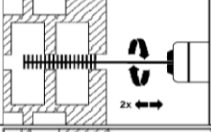
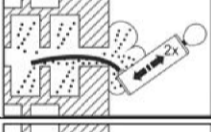
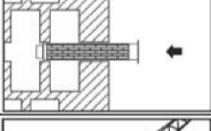
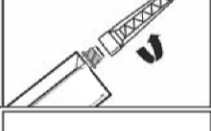
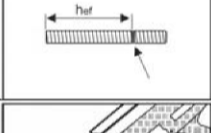
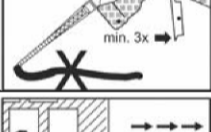
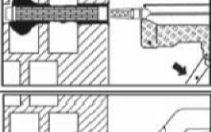
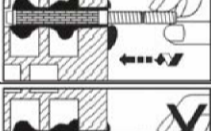


Injection System VMU plus for masonry

### Intended Use

Installation instructions (Solid masonry without sleeve)

Annex B6

## Installation Instructions - Solid or hollow masonry - with sleeve

1.		<p>Drill hole perpendicular to the surface of base material with drill method according to Annex C4-C45, with nominal drill hole diameter and bore hole depth according to the size and embedment depth required by the selected anchor. In case of aborted drill hole the drill hole shall be filled with mortar.</p>
2a.		<p><b>Drill hole must be cleaned prior to installation of the anchor.</b> Blow out from the bottom of the bore hole two times.</p>
2b.		<p>Attach the appropriate sized brush (acc.to Annex B4) to a drilling machine or a battery screwdriver, brush the hole clean two times.</p>
2c.		<p>Finally blow out the hole again two times.</p>
3.		<p>Insert the perforated sleeve flush with the surface of the masonry or plaster. Only use sleeves that have the right length. Never cut the sleeve.</p>
4.		<p>Remove the cap and attach the supplied static-mixing nozzle to the cartridge and load the cartridge into the correct dispensing tool. In case of a foil tube cartridge, cut off the clip before use. For every working interruption longer than the recommended working time (Table B4 or B5) as well as for new cartridges, a new static-mixer shall be used.</p>
5.		<p>The position of the embedment depth shall be marked on the threaded rod. The anchor rod shall be free of dirt, grease, oil or other foreign material.</p>
6.		<p>Initial adhesive is not suitable for fixing the anchor. Prior to dispensing into the anchor hole, squeeze out separately a minimum of three full strokes, for foil tube cartridges six full strokes and discard non-uniformly mixed adhesive components until the mortar shows a consistent grey colour.</p>
7.		<p>Starting from the bottom or back fill the sleeve with adhesive. For embedment depth equal to or larger than 130 mm an extension nozzle shall be used. For quantity of mortar attend cartridges label installation instructions. Observe the working times given in Table B4 or B5.</p>
8.		<p>Push the threaded rod into the anchor hole while turning slightly to ensure positive distribution of the adhesive until the embedment depth is reached.</p>
9.		<p>Allow the adhesive to cure to the specified curing time given in Table B4 or B5. Do not move or load the anchor until it is fully cured. After curing time remove access mortar.</p>
10.		<p>After full curing, the fixture can be installed with up to the max. installation torque acc. to Table B2 and B3 with calibrated torque wrench.</p>

### Injection System VMU plus for masonry

#### Intended Use

Installation Instruction (Solid or hollow masonry - with sleeve)

**Annex B7**



**Table C1:  $\beta$  - factor for job-site testing under tension loading**

Brick-No. and abbreviation	Installation & Use category	$\beta$ -Factor					
		$T_a: 40^\circ\text{C} / 24^\circ\text{C}$		$T_b: 80^\circ\text{C} / 50^\circ\text{C}$		$T_c: 120^\circ\text{C} / 72^\circ\text{C}$	
		d/d	w/d w/w	d/d	w/d w/w	d/d	w/d w/w
1 AAC6	All sizes	0,95	0,86	0,81	0,73	0,81	0,73
2 KS-NF	$d_0 \leq 14$ mm	0,93	0,80	0,87	0,74	0,65	0,56
	$d_0 \geq 16$ mm	0,93	0,93	0,87	0,87	0,65	0,65
3 KSL-3DF	$d_0 \leq 12$ mm	0,93	0,80	0,87	0,74	0,65	0,56
	$d_0 \geq 16$ mm	0,93	0,93	0,87	0,87	0,65	0,65
4 KSL-12DF	$d_0 \leq 12$ mm	0,93	0,80	0,87	0,74	0,65	0,56
	$d_0 \geq 16$ mm	0,93	0,93	0,87	0,87	0,65	0,65
5 MZ-DF	all sizes	0,86	0,86	0,86	0,86	0,73	0,73
6 Hz-16DF							
7 Porotherm Homebric							
8 BGV-Thermo							
9 Calibric R+							
10 Urbanbric							
11 Brique creuse C40							
12 Blocchi Leggeri							
13 Doppio Uni							
14 Bloc creux B40							
15 Solid lightweight concrete	$d_0 \leq 12$ mm	0,93	0,80	0,87	0,74	0,65	0,56
	$d_0 \geq 16$ mm	0,93	0,93	0,87	0,87	0,65	0,65

**Injection System VMU plus for masonry**

**Performances**

$\beta$  - factors for job site testing under tension load

**Annex C1**

**Table C2: Characteristic steel resistance under tension and shear load**

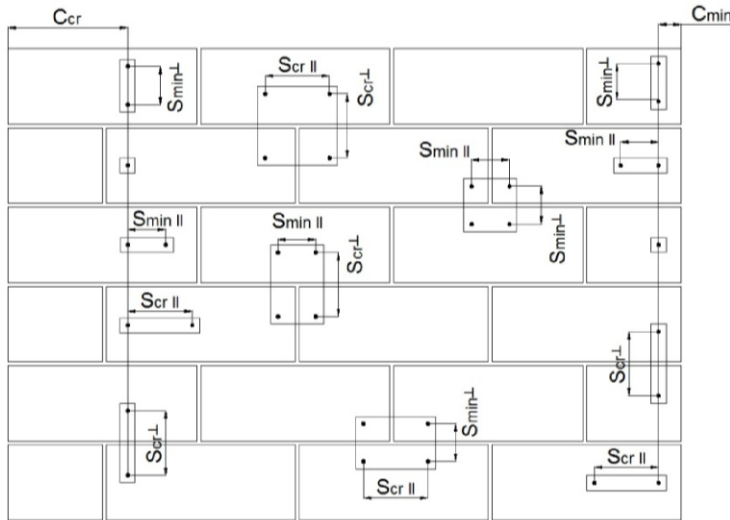
Anchor type			VMU-IG			VMU-A, V-A			
			M6	M8	M10	M8	M10	M12	M16
<b>Characteristic tension resistance</b>									
Steel, property class 4.6	$N_{RK,s}$	[kN]	-	-	-	15	23	34	63
	$\gamma_{Ms}$	[-]	-			2,0			
Steel, property class 4.8	$N_{RK,s}$	[kN]	-	-	-	15	23	34	63
	$\gamma_{Ms}$	[-]	-			1,5			
Steel, property class 5.6	$N_{RK,s}$	[kN]	10	18	29	18	29	42	79
	$\gamma_{Ms}$	[-]	2,0			2,0			
Steel, property class 5.8	$N_{RK,s}$	[kN]	10	17	29	18	29	42	79
	$\gamma_{Ms}$	[-]	1,5			1,5			
Steel, property class 8.8	$N_{RK,s}$	[kN]	16	27	46	29	46	67	126
	$\gamma_{Ms}$	[-]	1,5			1,5			
Stainless steel A4 / HCR, property class 70	$N_{RK,s}$	[kN]	14	26	41	26	41	59	110
	$\gamma_{Ms}$	[-]	1,87			1,87			
Stainless steel A4 / HCR, property class 80	$N_{RK,s}$	[kN]	16	29	46	29	46	67	126
	$\gamma_{Ms}$	[-]	1,6			1,6			
<b>Characteristic shear resistance</b>									
Steel, property class 4.6	$V_{RK,s}$	[kN]	-	-	-	7	12	17	31
	$\gamma_{Ms}$	[-]	-			1,67			
Steel, property class 4.8	$V_{RK,s}$	[kN]	-	-	-	7	12	17	31
	$\gamma_{Ms}$	[-]	-			1,25			
Steel, property class 5.6	$V_{RK,s}$	[kN]	5	9	15	9	15	21	39
	$\gamma_{Ms}$	[-]	1,67			1,67			
Steel, property class 5.8	$V_{RK,s}$	[kN]	5	9	15	9	15	21	39
	$\gamma_{Ms}$	[-]	1,25			1,25			
Steel, property class 8.8	$V_{RK,s}$	[kN]	8	14	23	15	23	34	63
	$\gamma_{Ms}$	[-]	1,25			1,25			
Stainless steel A4 / HCR, property class 70	$V_{RK,s}$	[kN]	7	13	20	13	20	30	55
	$\gamma_{Ms}$	[-]	1,56			1,56			
Stainless steel A4 / HCR, property class 80	$V_{RK,s}$	[kN]	8	15	23	15	23	34	63
	$\gamma_{Ms}$	[-]	1,33			1,33			
<b>Characteristic bending moment</b>									
Steel, property class 4.6	$M_{RK,s}$	[Nm]	-	-	-	15	30	52	133
	$\gamma_{Ms}$	[-]	-			1,67			
Steel, property class 4.8	$M_{RK,s}$	[Nm]	-	-	-	15	30	52	133
	$\gamma_{Ms}$	[-]	-			1,25			
Steel, property class 5.6	$M_{RK,s}$	[Nm]	8	19	37	19	37	66	167
	$\gamma_{Ms}$	[-]	1,67			1,67			
Steel, property class 5.8	$M_{RK,s}$	[Nm]	8	19	37	19	37	66	167
	$\gamma_{Ms}$	[-]	1,25			1,25			
Steel, property class 8.8	$M_{RK,s}$	[Nm]	12	30	60	30	60	105	266
	$\gamma_{Ms}$	[-]	1,25			1,25			
Stainless steel A4 / HCR, property class 70	$M_{RK,s}$	[Nm]	11	26	52	26	52	92	233
	$\gamma_{Ms}$	[-]	1,56			1,56			
Stainless steel A4 / HCR, property class 80	$M_{RK,s}$	[Nm]	12	30	60	30	60	105	266
	$\gamma_{Ms}$	[-]	1,33			1,33			

**Injection System VMU plus for masonry**
**Performances**

Characteristic steel resistance under tension and shear load

**Annex C2**

## Spacing and edge distance



$C_{cr}$  = Characteristic edge distance  
 $C_{min}$  = Minimum edge distance  
 $S_{cr}$  = Characteristic spacing  
 $S_{min}$  = Minimum spacing

$S_{cr,II}; (S_{min,II})$  = Characteristic (minimum) spacing for anchors placed parallel to bed joint  
 $S_{cr,\perp}; (S_{min,\perp})$  = Characteristic (minimum) spacing for anchors placed perpendicular to bed joint

Anchor position	Load direction		
	Tension load	Shear load parallel to free edge	Shear load perpendicular to free edge
Anchors places parallel to bed joint $S_{cr,II}; (S_{min,II})$			
Anchors places perpendicular to bed joint $S_{cr,\perp}; (S_{min,\perp})$			

$\alpha_{g,N,II}$  = Group factor in case of tension load for anchors placed parallel to the bed joint  
 $\alpha_{g,V,II}$  = Group factor in case of shear load for anchors placed parallel to the bed joint  
 $\alpha_{g,N,\perp}$  = Group factor in case of tension load for anchors placed perpendicular to the bed joint  
 $\alpha_{g,V,\perp}$  = Group factor in case of shear load for anchors placed perpendicular to the bed joint

Group of 2 anchors:  $N_{RK}^g = \alpha_{g,N} * N_{RK}$  and  $V_{RK}^g = \alpha_{g,V} * V_{RK}$

Group of 4 anchors:  $N_{RK}^g = \alpha_{g,N,II} * \alpha_{g,N,\perp} * N_{RK}$  and  $V_{RK}^g = \alpha_{g,V,II} * \alpha_{g,V,\perp} * V_{RK}$

( $N_{RK}$ :  $N_{RK,b}$  or  $N_{RK,b,j}$  for  $C_{cr}$ )

( $V_{RK}$ :  $V_{RK,c}$ ;  $V_{RK,c,j}$ ;  $V_{RK,b}$  or  $V_{RK,b,j}$  for  $C_{cr}$ )

(with the relevant  $\alpha_g$ )


## Injection System VMU plus for masonry

**Performances**  
 Edge distance and Spacing

**Annex C3**

## Brick type: Autoclaved Aerated Concrete – AAC6

**Table C3: Description of the brick**

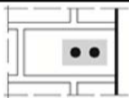
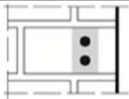
Brick type	Autoclaved Aerated Concrete AAC6		
Bulk density	$\rho$ [kg/dm <sup>3</sup> ]	0,6	
Compressive strength	$f_b \geq$ [N/mm <sup>2</sup> ]	6	
Code	EN 771-4		
Producer (country code)	e.g. Porit (DE)		
Brick dimensions	[mm]	499 x 240 x 249	
Drilling method	Rotary		

**Table C4: Spacing and edge distance**

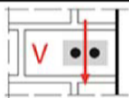
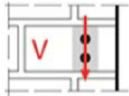
Anchor size			All sizes
Edge distance	$C_{cr}$	[mm]	$1,5 \cdot h_{ef}$
Minimum edge distance	$C_{min,N}$	[mm]	75
	$C_{min,V,II}$ ( $C_{min,v,\perp}$ ) <sup>1)</sup>	[mm]	$75 (1,5 \cdot h_{ef})$
Spacing	$S_{cr}$	[mm]	$3 \cdot h_{ef}$
Minimum spacing	$S_{min}$	[mm]	100

<sup>1)</sup>  $C_{min,V,II}$  for shear loading parallel to the free edge;  $C_{min,v,\perp}$  for shear loading perpendicular free edge

**Table C5: Group factor for anchor group in case of tension loading**

Configuration		with $c$ [mm] $\geq$	with $s$ [mm] $\geq$			
II: anchors placed parallel to horizontal joint		125 (120 for M8)	100	$\alpha_{g,N,II}$	[-]	1,8
		$1,5 \cdot h_{ef}$	$3 \cdot h_{ef}$			2,0
⊥: anchors placed perpendicular to horizontal joint		75	100	$\alpha_{g,N,\perp}$		1,4
		$1,5 \cdot h_{ef}$	$3 \cdot h_{ef}$			2,0

**Table C6: Group factor for anchor group in case of shear loading parallel to free edge**

Configuration		with $c$ [mm] $\geq$	with $s$ [mm] $\geq$			
II: anchors placed parallel to horizontal joint		75	100	$\alpha_{g,V,II}$	[-]	1,2
		$1,5 \cdot h_{ef}$	$3 \cdot h_{ef}$			2,0
⊥: anchors placed perpendicular to horizontal joint		$1,5 \cdot h_{ef}$	$3 \cdot h_{ef}$	$\alpha_{g,V,\perp}$		2,0

### Injection System VMU plus for masonry

**Performances - Autoclaved Aerated Concrete - AAC6**  
Description of the brick, Spacing and edge distance, Group factors

**Annex C4**

**Brick type: Autoclaved Aerated Concrete – AAC6**

**Table C7: Group factor for anchor group in case of shear loading perpendicular to free edge**

Configuration		with c [mm] ≥	with s [mm] ≥			
II: anchors placed parallel to horizontal joint		1,5*hef	3,0*hef	$\alpha_{g,V,II}$	[-]	2,0
I: anchors placed perpendicular to horizontal joint		1,5*hef	3,0*hef	$\alpha_{g,V,I}$		2,0

**Table C8: Characteristic values of resistance under tension and shear loads**

Anchor size	Effective anchorage depth	Characteristic resistance						
		Use category						
		d/d			w/w w/d			d/d w/d w/w
		40°C/24°C	80°C/50°C	120°C/72°C	40°C/24°C	80°C/50°C	120°C/72°C	All temperature ranges
hef	$N_{Rk,b} = N_{Rk,p}^{1)}$			$N_{Rk,b} = N_{Rk,p}^{1)}$			$V_{Rk,b}^{2)3)}$	
[mm]	[kN]							
Compressive strength $f_b \geq 6 \text{ N/mm}^2$								
M8	80	2,5 (2,0)	2,5 (1,5)	2,0 (1,2)	2,5 (1,5)	2,0 (1,5)	1,5 (1,2)	6,0
M10/IG-M6	90	4,0 (2,5)	3,0 (2,0)	2,5 (1,5)	3,5 (2,5)	3,0 (2,0)	2,5 (1,5)	10,0
M12/IG-M8	100	5,0 (3,5)	4,0 (3,0)	3,0 (2,5)	4,5 (3,0)	3,5 (2,5)	3,0 (2,5)	10,0
M16/IG-M10	100	6,5 (4,5)	5,5 (3,5)	4,0 (3,0)	5,5 (4,0)	5,0 (3,5)	4,0 (3,0)	10,0

<sup>1)</sup> Values are valid for  $c_{cr}$ , values in brackets are valid for single anchors with  $c_{min}$

<sup>2)</sup> For calculation of  $V_{Rk,c}$  see ETAG029, Annex C;

<sup>3)</sup> The values are valid for steel 5.6 or higher. For steel 4.6 and 4.8 multiply  $V_{Rk,b}$  by 0,8

**Table C9: Displacements**

Anchor size	hef	N	$\delta_N / N$	$\delta_{N0}$	$\delta_{N\infty}$	V	$\delta_{V0}$	$\delta_{V\infty}$
	[mm]	[kN]	[mm/kN]	[mm]	[mm]	[kN]	[mm]	[mm]
M8	80	0,9	0,18	0,16	0,32	1,3	0,8	1,20
M10/IG-M6	90	1,4		0,26	0,51	1,8	1,2	1,80
M12/IG-M8	100	1,8	0,08	0,14	0,29	2,1	1,4	2,10
M16/IG-M10	100	2,3		0,19	0,37	2,3	1,5	2,25

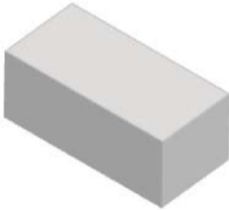
**Injection System VMU plus for masonry**

**Performances - Autoclaved Aerated Concrete – AAC6**  
Group factor, Characteristic values of resistance, Displacements

**Annex C5**

**Brick type: Calcium silicate solid brick KS-NF**

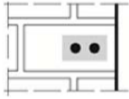
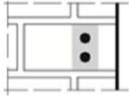
**Table C10: Description of the brick**

Brick type	Calcium silicate solid brick KS-NF		
Bulk density	$\rho$ [kg/dm <sup>3</sup> ]	2,0	
Compressive strength	$f_b \geq$ [N/mm <sup>2</sup> ]	10, 20 or 27	
Code	EN 771-2		
Producer (country code)	e.g. Wemding (DE)		
Brick dimensions	[mm]	240 x 115 x 71	
Drilling method	Hammer		

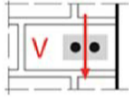
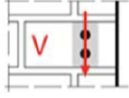
**Table C11: Spacing and edge distance**

Anchor size			All sizes
Edge distance	$C_{cr}$	[mm]	$1,5 \cdot h_{ef}$
Minimum edge distance	$C_{min}$	[mm]	60
Spacing	$S_{cr}$	[mm]	$3 \cdot h_{ef}$
Minimum spacing	$S_{min}$	[mm]	120

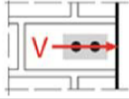
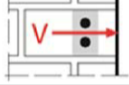
**Table C12: Group factor for anchor group in case of tension loading**

Configuration		with $c$ [mm] $\geq$	with $s$ [mm] $\geq$			
II: anchors placed parallel to horizontal joint 		60	120	$\alpha_{g,N,II}$	[-]	1,0
		140	120			1,5
		$1,5 \cdot h_{ef}$	$3 \cdot h_{ef}$			2,0
I: anchors placed perpendicular to horizontal joint 		60	120	$\alpha_{g,N,I}$	[-]	0,5
		$1,5 \cdot h_{ef}$	120			1,0
		$1,5 \cdot h_{ef}$	$3 \cdot h_{ef}$			2,0

**Table C13: Group factor for anchor group in case of shear loading parallel to free edge**

Configuration		with $c$ [mm] $\geq$	with $s$ [mm] $\geq$			
II: anchors placed parallel to horizontal joint 		60	120	$\alpha_{g,V,II}$	[-]	1,0
		115	120			1,7
		$1,5 \cdot h_{ef}$	$3 \cdot h_{ef}$			2,0
I: anchors placed perpendicular to horizontal joint 		60	120	$\alpha_{g,V,I}$	[-]	1,0
		$1,5 \cdot h_{ef}$	120			1,0
		$1,5 \cdot h_{ef}$	$3 \cdot h_{ef}$			2,0

**Table C14: Group factor for anchor group in case of shear loading perpendicular to free edge**

Configuration		with $c$ [mm] $\geq$	with $s$ [mm] $\geq$			
II: anchors placed parallel to horizontal joint 		60	120	$\alpha_{g,V,II}$	[-]	1,0
		$1,5 \cdot h_{ef}$	$3 \cdot h_{ef}$			2,0
I: anchors placed perpendicular to horizontal joint 		60	120	$\alpha_{g,V,I}$	[-]	1,0
		$1,5 \cdot h_{ef}$	$3 \cdot h_{ef}$			2,0

**Injection System VMU plus for masonry**

**Performances - Calcium solid brick KS-NF**  
 Description, Spacing and edge distance, Group factor

**Annex C6**

**Brick type: Calcium silicate solid brick KS-NF**

**Table C15: Characteristic values of resistance under tension and shear loads**

Anchor size	Sleeve	Effective anchorage depth	Characteristic resistance						
			Use category						
			d/d			w/d w/w			d/d w/d w/w
			40°C/24°C	80°C/50°C	120°C/72°C	40°C/24°C	80°C/50°C	120°C/72°C	All temperature ranges
			$N_{Rk,b} = N_{Rk,p}^{1)}$			$N_{Rk,b} = N_{Rk,p}^{1)}$			$V_{Rk,b}^{2)3)}$
		$h_{ef}$							
		[mm]	[kN]						
<b>Compressive strength <math>f_b \geq 10 \text{ N/mm}^2</math></b>									
M8	-	80							2,5 (1,5)
M10 / IG-M6	-	90	4,5 (2,0)	4,5 (2,0)	3,0 (1,5)	3,5 (1,5)	3,5 (1,5)	2,5 (1,2)	3,0 (2,0)
M12 / IG-M8	-	100							2,5 (1,5)
M16 / IG-M10	-	100	3,5 (1,5)	3,5 (1,5)	2,5 (1,2)	3,0 (1,5)	3,5 (1,5)	2,0 (0,9)	2,5 (1,5)
M8	12x80	80	3,5 (1,5)	3,5 (1,5)	2,5 (1,2)	3,5 (1,5)	3,0 (1,5)	2,5 (1,2)	2,5 (1,5)
M8 / M10 / IG-M6	16x85	85	3,5 (1,5)	3,0 (1,5)	2,0 (0,9)	3,5 (1,5)	3,0 (1,5)	2,5 (1,2)	2,5 (1,5)
	16x130	130	3,5 (1,5)	3,0 (1,5)	2,0 (0,9)	3,5 (1,5)	3,0 (1,5)	2,5 (1,2)	2,5 (1,5)
M12 / M16 / IG-M8 / IG-M10	20x85	85							
	20x130	130	3,0 (1,5)	2,5 (1,2)	2,0 (0,9)	3,0 (1,5)	2,5 (1,2)	2,0 (0,9)	2,5 (1,5)
	20x200	200							
<b>Compressive strength <math>f_b \geq 20 \text{ N/mm}^2</math></b>									
M8	-	80							4,0 (2,5)
M10 / IG-M6	-	90	6,0 (3,0)	5,5 (2,5)	4,0 (2,0)	5,0 (2,5)	5,0 (2,5)	3,5 (1,5)	4,5 (2,5)
M12 / IG-M8	-	100							4,0 (2,5)
M16 / IG-M10	-	100	5,0 (2,5)	5,0 (2,5)	3,5 (1,5)	5,0 (2,5)	5,0 (2,5)	3,5 (1,5)	4,0 (2,5)
M8	12x80	80	5,5 (2,5)	5,0 (2,5)	3,5 (1,5)	4,5 (2,0)	4,5 (2,0)	3,0 (1,5)	4,0 (2,5)
M8 / M10 / IG-M6	16x85	85	5,0 (2,5)	4,5 (2,0)	3,5 (1,5)	5,0 (2,5)	4,5 (2,0)	3,5 (1,5)	4,0 (2,5)
	16x130	130	5,0 (2,5)	4,5 (2,0)	3,5 (1,5)	5,0 (2,5)	4,5 (2,0)	3,5 (1,5)	4,0 (2,5)
M12 / M16 / IG-M8 / IG-M10	20x85	85							
	20x130	130	4,0 (2,0)	4,0 (2,0)	3,0 (1,5)	4,0 (2,0)	4,0 (2,0)	3,0 (1,5)	4,0 (2,5)
	20x200	200							

1) Values are valid for  $c_{gr}$ , values in brackets are valid for single anchors with  $c_{min}$   
 2) For  $c_{gr}$  calculation of  $V_{Rk,c}$  see ETAG 029, Annex C; values in brackets  $V_{Rk,c} = V_{Rk,b}$  for single anchors with  $c_{min}$   
 3) The values are valid for steel 5.6 or higher. For steel 4.6 and 4.8 multiply  $V_{Rk,b}$  by 0,8.

**Injection System VMU plus for masonry**

**Performances - Calcium solid brick KS-NF**  
 Characteristic values of resistance

**Annex C7**

**Brick type: Calcium silicate solid brick KS-NF**

**Table C16: Characteristic values of resistance under tension and shear loads (continue)**

Anchor size	Sleeve	Effective anchorage depth	Characteristic resistance						
			Use category						
			d/d			w/d			d/d
			w/w			w/w			w/d
			w/w			w/w			w/w
40°C/24°C	80°C/50°C	120°C/72°C	40°C/24°C	80°C/50°C	120°C/72°C	All temperature ranges			
$h_{ef}$	$N_{Rk,b} = N_{Rk,p}^{1)}$			$N_{Rk,b} = N_{Rk,p}^{1)}$			$V_{Rk,b}^{2)3)}$		
[mm]	[kN]								
<b>Compressive strength <math>f_b \geq 27 \text{ N/mm}^2</math></b>									
M8	-	80							4,5 (2,5)
M10 / IG-M6	-	90	7,0 (3,5)	6,5 (3,0)	5,0 (2,5)	6,0 (3,0)	5,5 (2,5)	4,0 (2,0)	5,5 (3,0)
M12 / IG-M8	-	100							4,5 (2,5)
M16 / IG-M10	-	100	6,0 (3,0)	5,5 (2,5)	4,5 (2,0)	6,0 (3,0)	5,5 (2,5)	4,0 (2,0)	4,5 (2,5)
M8	12x80	80	6,5 (3,0)	6,0 (3,0)	4,5 (2,0)	5,5 (2,5)	5,0 (2,5)	3,5 (1,5)	4,5 (2,5)
M8 / M10 / IG-M6	16x85	85	5,5 (2,5)	5,0 (2,5)	4,0 (2,0)	5,5 (2,5)	5,0 (2,5)	4,0 (2,0)	4,5 (2,5)
	16x130	130	5,5 (2,5)	5,0 (2,5)	4,0 (2,0)	5,5 (2,5)	5,0 (2,5)	4,0 (2,0)	4,5 (2,5)
M12 / M16 / IG-M8 / IG-M10	20x85	85							
	20x130	130	5,0 (2,5)	4,5 (2,0)	3,5 (1,5)	5,0 (2,5)	4,5 (2,0)	3,5 (1,5)	4,5 (2,5)
	20x200	200							

- 1) Values are valid for  $c_{cr}$ , values in brackets are valid for single anchors with  $c_{min}$   
 2) For  $c_{cr}$  calculation of  $V_{Rk,c}$  see ETAG 029, Annex C; values in brackets  $V_{Rk,c} = V_{Rk,b}$  for single anchors with  $c_{min}$   
 3) The values are valid for steel 5.6 or higher. For steel 4.6 and 4.8 multiply  $V_{Rk,b}$  by 0,8

**Table C17: Displacements**

Anchor size	Sleeve	$h_{ef}$	N	$\delta_N / N$	$\delta_{N0}$	$\delta_{N\infty}$	V	$\delta_{V0}$	$\delta_{V\infty}$
		[mm]	[kN]	[mm/kN]	[mm]	[mm]	[kN]	[mm]	[mm]
M8	-	80					1,7	0,90	1,35
M10 / IG-M6	-	90	2,0		0,30	0,60	2,0	1,10	1,65
M12 / IG-M8	-	100							
M16 / IG-M10	-	100	1,7	0,15	0,26	0,51			
M8	12x80	80							
							1,7	0,90	1,35
M8 / M10 / IG-M6	16x85	85	1,4		0,21	0,43			
	16x130	130							
M12 / M16 / IG-M8 / IG-M10	20x85	85							
	20x130	130	1,3		0,19	0,39			
	20x200	200							

**Injection System VMU plus for masonry**

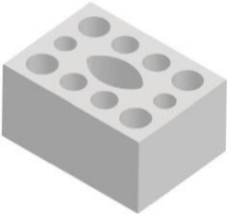
**Performances - Calcium solid brick KS-NF**  
 Characteristic values of resistance (continue), Displacements

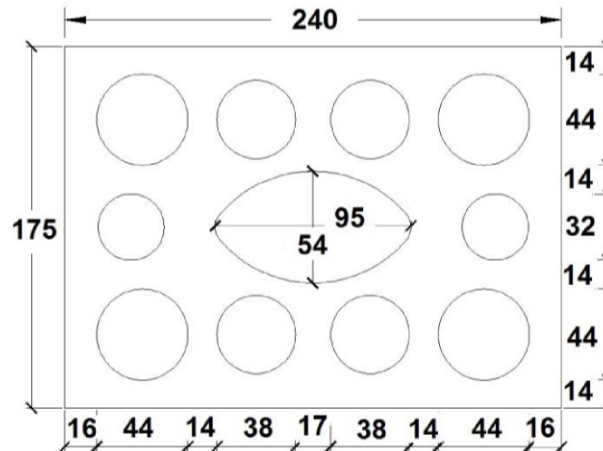
**Annex C8**



**Brick type: Calcium silicate hollow brick KSL-3DF**

**Table C18: Description of the brick**

Brick type	Calcium silicate hollow brick KSL-3DF		
Bulk density	$\rho$ [kg/dm <sup>3</sup> ]	1,4	
Compressive strength	$f_b \geq$ [N/mm <sup>2</sup> ]	8, 12 or 14	
Code	EN 771-2		
Producer (country code)	e.g. Wemding (DE)		
Brick dimensions	[mm]	240 x 175 x 113	
Drilling method	Rotary		

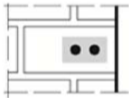
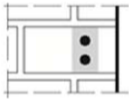


**Table C19: Spacing and edge distance**

Anchor size			All sizes
Edge distance	$c_{cr}$	[mm]	100 (120) <sup>1)</sup>
Minimum edge distance	$c_{min}$	[mm]	60
Spacing	$s_{cr,II}$	[mm]	240
	$s_{cr,I}$	[mm]	120
Minimum spacing	$s_{min}$	[mm]	120

<sup>1)</sup> Value in brackets for VM-SH 20x85; VM-SH 20x130 and VM-SH 20x200

**Table C20: Group factor for anchor group in case of tension loading**

Configuration		with $c$ [mm] $\geq$	with $s$ [mm] $\geq$			
II: anchors placed parallel to horizontal joint		60	120	$\alpha_{g,N,II}$	[-]	1,5
		$c_{cr}$	240			2,0
		160	120			2,0
I: anchors placed perpendicular to horizontal joint		60	120	$\alpha_{g,N,I}$	[-]	1,0
		$c_{cr}$	120			2,0

**Injection System VMU plus for masonry**

**Performances - Calcium silicate hollow brick KSL-3DF**  
Description of the brick, Spacing and edge distance, Group factor

**Annex C9**

**Brick type: Calcium silicate hollow brick KSL-3DF**

**Table C21: Group factor for anchor group in case of shear loading parallel to free edge**

Configuration		with c [mm] ≥	with s [mm] ≥			
II: anchors placed parallel to horizontal joint		60	120	$\alpha_{g,V,II}$	[-]	1,0
		160	120			1,6
		$c_{cr}$	240			2,0
I: anchors placed perpendicular to horizontal joint		60	120	$\alpha_{g,V,I}$	[-]	1,0
		$c_{cr}$	120			2,0

**Table C22: Group factor for anchor group in case of shear loading perpendicular to free edge**

Configuration		with c [mm] ≥	with s [mm] ≥			
II: anchors placed parallel to horizontal joint		60	120	$\alpha_{g,V,II}$	[-]	1,0
		$c_{cr}$	240			2,0
I: anchors placed perpendicular to horizontal joint		60	120	$\alpha_{g,V,I}$	[-]	1,0
		$c_{cr}$	120			2,0

**Table C23: Characteristic values of resistance under tension and shear loads**

Anchor size	Sleeve	Effective anchorage depth	Characteristic resistance						
			Use category						
			d/d			w/d; w/w			d/d; w/d; w/w
			40°C/24°C	80°C/50°C	120°C/72°C	40°C/24°C	80°C/50°C	120°C/72°C	All temperature ranges
		$h_{ef}$	$N_{Rk,b} = N_{Rk,p}^{1)}$			$N_{Rk,b} = N_{Rk,p}^{1)}$			$V_{Rk,b}^{4)}$
		[mm]	[kN]						
<b>Compressive strength <math>f_b \geq 8 \text{ N/mm}^2</math></b>									
M8	12x80	80					1,2	0,9	$2,5^{2)} (0,9)^{3)}$
M8 / M10 / IG-M6	16x85	85	1,5	1,5	1,2	1,5	1,5	1,2	$4,0^{2)} (1,5)^{3)}$
	16x130	130					1,5	1,2	$4,0^{2)} (1,5)^{3)}$
M12 / M16 / IG-M8 / IG-M10	20x85	85							
	20x130	130	4,5	4,0	3,0	4,5	4,0	3,0	$4,0^{2)} (1,5)^{3)}$
	20x200	200							
<b>Compressive strength <math>f_b \geq 12 \text{ N/mm}^2</math></b>									
M8	12x80	80	2,0	2,0	1,5	2,0	1,5	1,2	$3,0^{2)} (1,2)^{3)}$
M8 / M10 / IG-M6	16x85	85	2,0	2,0	1,5	2,0	2,0	1,5	$4,5^{2)} (1,5)^{3)}$
	16x130	130	2,5	2,5	1,5	2,5	2,5	1,5	$4,5^{2)} (1,5)^{3)}$
M12 / M16 / IG-M8 / IG-M10	20x85	85							
	20x130	130	6,0	5,5	4,0	6,0	5,5	4,0	$4,5^{2)} (1,5)^{3)}$
	20x200	200							

1) Values are valid for  $c_{cr}$  and  $c_{min}$

2)  $V_{Rk,c,II} = V_{Rk,b}$  valid for shear load parallel to free edge

3)  $V_{Rk,c,I} = V_{Rk,b}$  (values in brackets) valid for shear load in direction to free edge

4) The values are valid for steel 5.6 or higher. For steel 4.6 and 4.8 multiply  $V_{Rk,b}$  by 0,8

**Injection System VMU plus for masonry**

**Performances - Calcium silicate hollow brick KSL-3DF**  
Group factor, Characteristic values of resistance

**Annex C10**

**Brick type: Calcium silicate hollow brick KSL-3DF**

**Table C24: Characteristic values of resistance under tension and shear loads (continue)**

Anchor size	Sleeve	Effective anchorage depth	Characteristic resistance							
			Use category							
			d/d			w/d; w/w			d/d; w/d; w/w	
			40°C/24°C	80°C/50°C	120°C/72°C	40°C/24°C	80°C/50°C	120°C/72°C	All temperature ranges	
$h_{ef}$	$N_{Rk,b} = N_{Rk,p}^{1)}$			$N_{Rk,b} = N_{Rk,p}^{1)}$			$V_{Rk,b}^{4)}$			
[mm]	[kN]									
Compressive strength $f_b \geq 14 \text{ N/mm}^2$										
M8	12x80	80	2,5	2,5	1,5	2,0	2,0	1,5	3,5 <sup>2)</sup> (1,5) <sup>3)</sup>	
M8 / M10 / IG-M6	16x85	85	2,5	2,5	1,5	2,5	2,5	1,5	6,0 <sup>2)</sup> (2,0) <sup>3)</sup>	
	16x130	130	2,5	2,5	2,0	2,5	2,5	2,0	6,0 <sup>2)</sup> (2,0) <sup>3)</sup>	
M12 / M16 / IG-M8 / IG-M10	20x85	85	6,5	6,0	4,5	6,5	6,0	4,5	6,0 <sup>2)</sup> (2,0) <sup>3)</sup>	
	20x130	130								
	20x200	200								

- 1) Values are valid for  $c_{gr}$  and  $c_{min}$   
 2)  $V_{Rk,c,II} = V_{Rk,b}$  valid for shear load parallel to free edge  
 3)  $V_{Rk,c,I} = V_{Rk,b}$  (values in brackets) valid for shear load in direction to free edge  
 4) The values are valid for steel 5.6 or higher. For steel 4.6 and 4.8 multiply  $V_{Rk,b}$  by 0,8

**Table C25: Displacements**

Anchor size	Sleeve	$h_{ef}$	N	$\delta_N / N$	$\delta_{N0}$	$\delta_{N\infty}$	V	$\delta_{V0}$	$\delta_{V\infty}$
		[mm]	[kN]	[mm/kN]	[mm]	[mm]	[kN]	[mm]	[mm]
M8	12x80	80	0,71	0,90	0,64	1,29	1,0	1,0	1,50
M8 / M10 / IG-M6	16x85	85							
		16x130	130						
M12 / M16 / IG-M8 / IG-M10	20x85	85	1,86	0,90	1,67	3,34	1,7	1,9	2,85
	20x130	130							
	20x200	200							


**Injection System VMU plus for masonry**

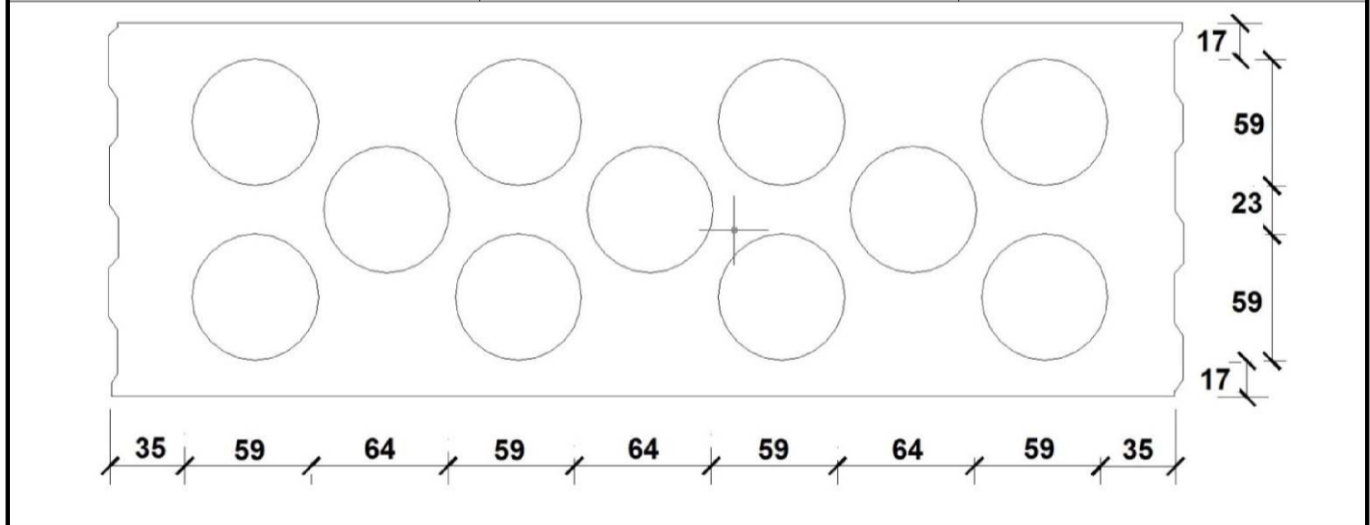
**Performance - Calcium silicate hollow brick KSL-3DF**  
 Characteristic values of resistance, Displacements

**Annex C11**

**Brick type: Calcium silicate hollow brick KSL-12DF**

**Table C26: Description of the brick**

<b>Brick type</b>	Calcium silicate hollow brick KSL-12DF		
Bulk density	$\rho$ [kg/dm <sup>3</sup> ]	1,4	
Compressive strength	$f_b \geq$ [N/mm <sup>2</sup> ]	10, 12 or 16	
Code	EN 771-2		
Producer (country code)	e.g. Wemding (DE)		
Brick dimensions	[mm]	498 x 175 x 238	
Drilling method	Rotary		




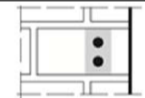
**Table C27: Spacing and edge distances**

Anchor size			All sizes
Edge distance	$c_{cr}$	[mm]	100 (120) <sup>1)</sup>
Minimum edge distance	$c_{min}$ <sup>2)</sup>	[mm]	100 (120) <sup>1)</sup>
Spacing	$s_{cr,II}$	[mm]	498
	$s_{cr,\perp}$	[mm]	238
Minimum spacing	$s_{min}$	[mm]	120

1) Value in brackets for VM-SH 20x85 and VM-SH 20x130

2) For  $V_{Rk,c}$ :  $c_{min}$  according to ETAG 029, Annex C

**Table C28: Group factor for anchor group in case of tension loading**

Configuration		with $c$ [mm] $\geq$	with $s$ [mm] $\geq$			
II: anchors placed parallel to horizontal joint		100	120	$\alpha_{g,N,II}$	[-]	1,0
		$c_{cr}$	498			2,0
⊥: anchors placed perpendicular to horizontal joint		100	120	$\alpha_{g,N,\perp}$	[-]	1,0
		$c_{cr}$	238			2,0

**Injection System VMU plus for masonry**

**Annex C12**

**Performance - Calcium silicate hollow brick KSL-12DF**

Description of the brick, Spacing and edge distances, Group factor

**Brick type: Calcium silicate hollow brick KSL-12DF**

**Table C29: Group factor for anchor group in case of shear loading parallel to free edge**

Configuration		with c [mm] ≥	with s [mm] ≥			
II: anchors placed parallel to horizontal joint		$C_{Cr}$	498	$\alpha_{g,V,II}$	[-]	2,0
I: anchors placed perpendicular to horizontal joint		$C_{Cr}$	238	$\alpha_{g,V,I}$		2,0

**Table C30: Group factor for anchor group in case of shear load perpendicular to free edge**

Configuration		with c [mm] ≥	with s [mm] ≥			
II: anchors placed parallel to horizontal joint		$C_{Cr}$	498	$\alpha_{g,V,II}$	[-]	2,0
I: anchors placed perpendicular to horizontal joint		$C_{Cr}$	238	$\alpha_{g,V,I}$		2,0

**Table C31: Characteristic values of resistance under tension and shear loads**

Anchor size	Sleeve	Effective anchorage depth	Characteristic resistance						
			Use category						
			d/d			w/d; w/w			d/d w/d w/w
			40°C/24°C	80°C/50°C	120°C/72°C	40°C/24°C	80°C/50°C	120°C/72°C	All temperature ranges
		$h_{ef}$	$N_{Rk,b} = N_{Rk,p}^{1)}$			$N_{Rk,b} = N_{Rk,p}^{1)}$			$V_{Rk,b}^{2)3)}$
		[mm]	[kN]						
<b>Compressive strength <math>f_b \geq 10 \text{ N/mm}^2</math></b>									
M8	12x80	80	0,6	0,6	0,4	0,5	0,5	0,4	2,5
M8 / M10 / IG-M6	16x85	85	0,6	0,6	0,4	0,6	0,6	0,4	5,5
	16x130	130	2,5	2,5	2,0	2,5	2,5	2,0	5,5
M12 / M16 / IG-M8 / IG-M10	20x85	85	1,5	1,5	0,9	1,5	1,5	0,9	5,5
	20x130	130	2,5	2,5	2,0	2,5	2,5	2,0	5,5
<b>Compressive strength <math>f_b \geq 12 \text{ N/mm}^2</math></b>									
M8	12x80	80	0,75	0,6	0,5	0,6	0,6	0,4	3,0
M8 / M10 / IG-M6	16x85	85	0,75	0,6	0,5	0,75	0,6	0,5	6,5
	16x130	130	3,0	3,0	2,0	3,0	3,0	2,0	6,5
M12 / M16 / IG-M8 / IG-M10	20x85	85	1,5	1,5	1,2	1,5	1,5	1,2	6,5
	20x130	130	3,0	3,0	2,0	3,0	3,0	2,0	6,5

1) Values are valid for  $C_{Cr}$  and  $C_{min}$

2) Calculation of  $V_{Rk,c}$  see ETAG 029, Annex C, except for shear load parallel to free edge with  $c \geq 120 \text{ mm}$ :  $V_{Rk,c,II} = V_{Rk,b}$

3) The values are valid for steel 5.6 or higher. For steel 4.6 and 4.8 multiply  $V_{Rk,b}$  by 0,8

**Injection System VMU plus for masonry**

**Performance - Calcium silicate hollow brick KSL-12DF**

Group factor, Characteristic values of resistance

**Annex C13**

**Brick type: Calcium silicate hollow brick KSL-12DF**

**Table C32: Characteristic values of resistance under tension and shear loads (continue)**

Anchor size	Sleeve	Effective anchorage depth	Characteristic resistance						
			Use category						
			d/d			w/d; w/w			d/d w/d w/w
			40°C/24°C	80°C/50°C	120°C/72°C	40°C/24°C	80°C/50°C	120°C/72°C	All temperature ranges
			$N_{Rk,b} = N_{Rk,p}^{1)}$			$N_{Rk,b} = N_{Rk,p}^{1)}$			$V_{Rk,b}^{2)3)}$
$h_{ef}$		[kN]							
[mm]		Compressive strength $f_b \geq 16 \text{ N/mm}^2$							
M8	12x80	80	0,9	0,9	0,6	0,75	0,75	0,5	3,5
M8 / M10 / IG-M6	16x85	85	0,9	0,9	0,6	0,9	0,9	0,6	8,0
	16x130	130	4,0	3,5	2,5	4,0	3,5	2,5	8,0
M12 / M16 / IG-M8 / IG-M10	20x85	85	2,0	2,0	1,5	2,0	2,0	1,5	8,0
	20x130	130	4,0	3,5	2,5	4,0	3,5	2,5	8,0

1) Values are valid for  $c_{gr}$  and  $c_{min}$

2) Calculation of  $V_{Rk,c}$  see ETAG 029, Annex C, except for shear load parallel to free edge with  $c \geq 120 \text{ mm}$ :  $V_{Rk,c,II} = V_{Rk,b}$

3) The values are valid for steel 5.6 or higher. For steel 4.6 and 4.8 multiply  $V_{Rk,b}$  by 0,8

**Table C33: Displacements**

Anchor size	Sleeve	$h_{ef}$	N	$\delta_N / N$	$\delta_{N0}$	$\delta_{N\infty}$	V	$\delta_{V0}$	$\delta_{V\infty}$
		[mm]	[kN]	[mm/kN]	[mm]	[mm]	[kN]	[mm]	[mm]
M8	12x80	80	0,26	0,90	0,23	0,46	1,0	1,3	1,95
M8 / M10 / IG-M6	16x85	85			1,03	2,06	2,3	2,5	3,75
	16x130	130	0,51		1,03				
M12 / M16 / IG-M8 / IG-M10	20x85	85	1,03		2,06				
	20x130	130	1,14						

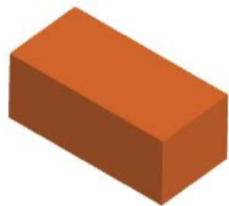
**Injection System VMU plus for masonry**

**Performance - Calcium silicate hollow brick KSL-12DF**  
Characteristic values of resistance (continue), Displacements

**Annex C14**

**Brick type: Clay solid brick Mz-DF**


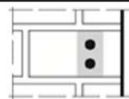
**Table C34: Description of the brick**

Brick type	Clay solid brick Mz-DF		
Bulk density	$\rho$ [kg/dm <sup>3</sup> ]	1,6	
Compressive strength	$f_b \geq$ [N/mm <sup>2</sup> ]	10, 20 or 28	
Code	EN 771-1		
Producer (country code)	e.g. Unipor (DE)		
Brick dimensions	[mm]	240 x 115 x 55	
Drilling method	Hammer		

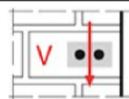

**Table C35: Spacing and edge distances**

Anchor size			Alle Größen
Edge distance	$c_{cr}$	[mm]	$1,5 \cdot h_{ef}$
Minimum edge distance	$c_{min}$	[mm]	60
Spacing	$s_{cr}$	[mm]	$3 \cdot h_{ef}$
Minimum spacing	$s_{min}$	[mm]	120

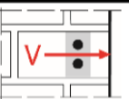

**Table C36: Group factor for anchor group in case of tension loading**

Configuration		with $c$ [mm] $\geq$	with $s$ [mm] $\geq$			
II: anchors placed parallel to horizontal joint 		60	120	$\alpha_{g,N,II}$	[-]	0,7
		$1,5 \cdot h_{ef}$	$3 \cdot h_{ef}$			2,0
I: anchors placed perpendicular to horizontal joint 		60	120	$\alpha_{g,N,I}$		0,5
		$1,5 \cdot h_{ef}$	120			1,0
		$1,5 \cdot h_{ef}$	$3 \cdot h_{ef}$		2,0	

**Table C37: Group factor for anchor group in case of shear loading parallel to free edge**

Configuration		with $c$ [mm] $\geq$	with $s$ [mm] $\geq$			
II: anchors placed parallel to horizontal joint 		60	120	$\alpha_{g,V,II}$	[-]	0,5
		90	120			1,1
		$1,5 \cdot h_{ef}$	$3 \cdot h_{ef}$			2,0
I: anchors placed perpendicular to horizontal joint 		60	120	$\alpha_{g,V,I}$		0,5
		$1,5 \cdot h_{ef}$	120			1,0
		$1,5 \cdot h_{ef}$	$3 \cdot h_{ef}$			2,0

**Table C38: Group factor for anchor group in case of shear load perpendicular to free edge**

Configuration		with $c$ [mm] $\geq$	with $s$ [mm] $\geq$			
II: anchors placed parallel to horizontal joint 		60	120	$\alpha_{g,V,II}$	[-]	0,5
		$1,5 \cdot h_{ef}$	120			1,0
		$1,5 \cdot h_{ef}$	$3 \cdot h_{ef}$			2,0
I: anchors placed perpendicular to horizontal joint 		60	120	$\alpha_{g,V,I}$		0,5
		$1,5 \cdot h_{ef}$	120			1,0
		$1,5 \cdot h_{ef}$	$3 \cdot h_{ef}$			2,0

**Injection System VMU plus for masonry**

**Performance - Clay solid brick Mz-DF**

Description of the brick , Spacing and edge distances, Group factor

**Annex C15**

**Brick type: Clay solid brick Mz-DF**

**Table C39: Characteristic values of resistance under tension and shear loads**

Anchor size	Sleeve	Effective Anchorage depth	Characteristic resistance			
			Use category			
			d/d w/d w/w			d/d w/d w/w
			40°C/24°C	80°C/50°C	120°C/72°C	All temperature ranges
$h_{ef}$ [mm]	$N_{Rk,b} = N_{Rk,p}^{1)}$			$V_{Rk,b}^{2)3)}$		
[kN]						
<b>Compressive strength <math>f_b \geq 10 \text{ N/mm}^2</math></b>						
M8	-	80	3,5 (1,5)	3,5 (1,5)	2,5 (1,2)	3,5 (1,2)
M10 / IG-M6	-	90	3,5 (1,5)	3,5 (1,5)	3,0 (1,5)	3,5 (1,2)
M12 / IG-M8	-	100	4,0 (2,0)	4,0 (2,0)	3,5 (1,5)	3,5 (1,2)
M16 / IG-M10	-	100	4,0 (2,0)	4,0 (2,0)	3,5 (1,5)	5,5 (1,5)
M8	12x80	80	3,5 (1,5)	3,5 (1,5)	3,0 (1,2)	3,5 (1,2)
M8 / M10 / IG-M6	16x85	85	3,5 (1,5)	3,5 (1,5)	3,0 (1,5)	3,5 (1,2)
	16x130	130				
M12 / M16 / IG-M8 / IG-M10	20x85	85				
	20x130	130				
	20x200	200				
<b>Compressive strength <math>f_b \geq 20 \text{ N/mm}^2</math></b>						
M8	-	80	4,5 (2,5)	4,5 (2,5)	4,0 (2,0)	5,0 (1,5)
M10 / IG-M6	-	90	5,5 (2,5)	5,5 (2,5)	4,5 (2,0)	5,0 (1,5)
M12 / IG-M8	-	100	6,0 (3,0)	6,0 (3,0)	5,0 (2,5)	5,0 (1,5)
M16 / IG-M10	-	100	6,0 (3,0)	6,0 (3,0)	5,0 (2,5)	8,0 (2,5)
M8	12x80	80	4,5 (2,5)	4,5 (2,5)	4,0 (2,0)	5,0 (1,5)
M8 / M10 / IG-M6	16x85	85	5,0 (2,5)	5,0 (2,5)	4,0 (2,0)	5,0 (1,5)
	16x130	130				
M12 / M16 / IG-M8 / IG-M10	20x85	85				
	20x130	130				
	20x200	200				
<b>Compressive strength <math>f_b \geq 28 \text{ N/mm}^2</math></b>						
M8	-	80	5,5 (2,5)	5,5 (2,5)	4,5 (2,5)	5,5 (2,0)
M10 / IG-M6	-	90	6,0 (3,0)	6,0 (3,0)	5,0 (2,5)	5,5 (2,0)
M12 / IG-M8	-	100	7,0 (3,5)	7,0 (3,5)	6,0 (3,0)	5,5 (2,0)
M16 / IG-M10	-	100	7,0 (3,5)	7,0 (3,5)	6,0 (3,0)	9,0 (3,0)
M8	12x80	80	5,5 (2,5)	5,5 (2,5)	4,5 (2,5)	5,5 (2,0)
M8 / M10 / IG-M6	16x85	85	6,0 (3,0)	6,0 (3,0)	5,0 (2,5)	5,5 (2,0)
	16x130	130				
M12 / M16 / IG-M8 / IG-M10	20x85	85				
	20x130	130				
	20x200	200				

1) Values are valid for  $c_{cr}$ , values in brackets are valid for single anchors with  $c_{min}$   
 2) For  $c_{cr}$  calculation of  $V_{Rk,c}$  see ETAG 029, Annex C; for  $c_{min}$  values in brackets  $V_{Rk,c} = V_{Rk,b}$   
 3) The values are valid for steel 5.6 or higher. For steel 4.6 and 4.8 multiply  $V_{Rk,b}$  by 0,8.

**Injection System VMU plus for masonry**

**Performance - Clay solid brick Mz-DF**  
 Characteristic values of resistance

**Annex C16**



**Brick type: Clay solid brick Mz-DF**

**Table C40: Displacements**

Anchor size	Sleeve	$h_{ef}$	N	$\tilde{\delta}_N / N$	$\tilde{\delta}_{N0}$	$\tilde{\delta}_{N\infty}$	V	$\tilde{\delta}_{V0}$	$\tilde{\delta}_{V\infty}$
		[mm]	[kN]	[mm/kN]	[mm]	[mm]	[kN]	[mm]	[mm]
M8	-	80	1,3	0,15	0,19	0,39	1,9	1,00	1,50
M10 / IG-M6	-	90	1,6		0,24	0,47			
M12 / IG-M8	-	100	1,7		0,26	0,51			
M16 / IG-M10	-	100							
M8	12x80	80	1,3		0,19	0,39	1,9		
M8 / M10 / IG-M6	16x85	85							
	16x130	130							
M12 / M16 / IG-M8 / IG-M10	20x85	85							
	20x130	130							
	20x200	200							

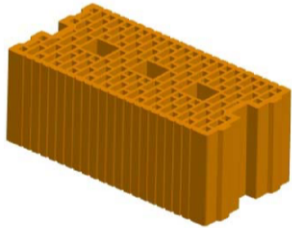
**Injection System VMU plus for masonry**

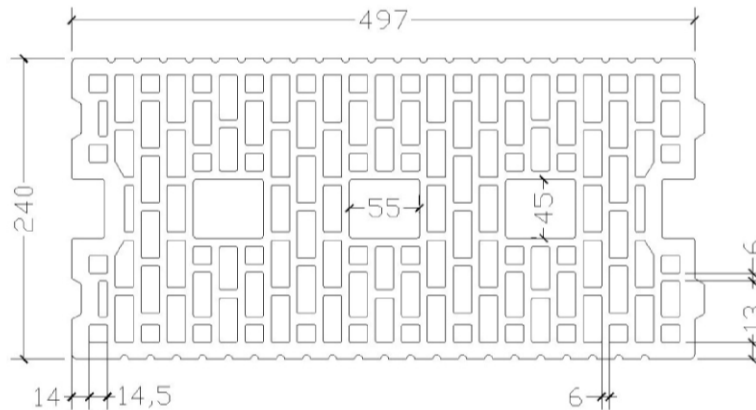
**Performance - Clay solid brick Mz-DF**  
Displacements

**Annex C17**

**Brick type: Clay hollow brick HLz-16-DF**

**Table C41: Description of the brick**

<b>Brick type</b>	Clay hollow brick HLz-16-DF		
Bulk density	$\rho$ [kg/dm <sup>3</sup> ]	0,8	
Compressive strength	$f_b \geq$ [N/mm <sup>2</sup> ]	6, 8, 12 or 14	
Code	EN 771-1		
Producer (country code)	e.g. Unipor (DE)		
Brick dimensions	[mm]	497 x 240 x 238	
Drilling method	Rotary		



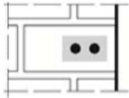
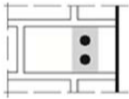
**Table C42: Spacing and edge distances**

Anchor size			All sizes
Edge distance	$c_{cr}$	[mm]	100 (120) <sup>1)</sup>
Minimum edge distance	$c_{min}$ <sup>2)</sup>	[mm]	100 (120) <sup>1)</sup>
Spacing	$s_{cr,II}$	[mm]	497
	$s_{cr,I}$	[mm]	238
Minimum spacing	$s_{min}$	[mm]	100

<sup>1)</sup> Value in bracket for VM-SH 20x85; VM-SH 20x130 and VM-SH 20x200

<sup>2)</sup> For  $V_{Rk,c}$ :  $c_{min}$  according to ETAG 029, Annex C

**Table C43: Group factor for anchor group in case of tension loading**

Configuration		with $c$ [mm] $\geq$	with $s$ [mm] $\geq$			
II: anchors placed parallel to horizontal joint		$c_{cr}$	100	$\alpha_{g,N,II}$	[-]	1,3
		$c_{cr}$	497			2,0
I: anchors placed perpendicular to horizontal joint		$c_{cr}$	100	$\alpha_{g,N,I}$	[-]	1,1
		$c_{cr}$	238			2,0

**Injection System VMU plus for masonry**

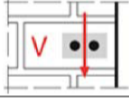
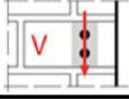
**Performance - Clay hollow brick HLz-16DF**

Description of the brick, Spacing and edge distances, Group factor

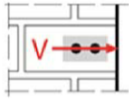
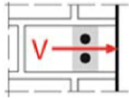
**Annex C18**

**Brick type: Clay hollow brick HLz-16-DF**

**Table C44: Group factor for anchor group in case of shear loading parallel to free edge**

Configuration		with c [mm] ≥	with s [mm] ≥			
II: anchors placed parallel to horizontal joint		$C_{cr}$	497	$\alpha_{g,V,II}$	[-]	2,0
I: anchors placed perpendicular to horizontal joint		$C_{cr}$	238	$\alpha_{g,V,I}$		2,0

**Table C45: Group factor for anchor group in case of shear load perpendicular to free edge**

Configuration		with c [mm] ≥	with s [mm] ≥			
II: anchors placed parallel to horizontal joint		$C_{cr}$	497	$\alpha_{g,V,II}$	[-]	2,0
I: anchors placed perpendicular to horizontal joint		$C_{cr}$	238	$\alpha_{g,V,I}$		2,0

**Table C46: Characteristic values of resistance under tension and shear loads**

Anchor size	Sleeve	Effective Anchorage depth	Characteristic resistance			
			Use category			
			d/d		d/d	
			w/d	w/d	w/w	w/w
		40°C/24°C	80°C/50°C	120°C/72°C	All temperature ranges	
		$h_{ef}$	$N_{Rk,b} = N_{Rk,p}^{1)}$		$V_{Rk,b}^{2)3)}$	
		[mm]	[kN]		[kN]	
<b>Compressive strength <math>f_b \geq 6 \text{ N/mm}^2</math></b>						
M8	12x80	80	2,5	2,5	2,0	2,5
M8 / M10/ IG-M6	16x85	85	2,5	2,5	2,0	4,5
	16x130	130	3,5	3,5	3,0	4,5
M12 / M16 / IG-M8 / IG-M10	20x85	85	2,5	2,5	2,0	5,0
	20x130	130	3,5	3,5	3,0	6,0
	20x200	200	3,5	3,5	3,0	6,0
<b>Compressive strength <math>f_b \geq 8 \text{ N/mm}^2</math></b>						
M8	12x80	80	3,0	3,0	2,5	3,0
M8 / M10/ IG-M6	16x85	85	3,0	3,0	2,5	5,5
	16x130	130	4,5	4,5	3,5	5,5
M12 / M16 / IG-M8 / IG-M10	20x85	85	3,0	3,0	2,5	6,0
	20x130	130	4,5	4,5	3,5	7,0
	20x200	200	4,5	4,5	3,5	7,0

1) Values are valid for  $c_{cr}$  and  $c_{min}$

2) Calculation of  $V_{Rk,c}$  see ETAG 029, Annex C, except for shear load parallel to free edge with  $c \geq 125 \text{ mm}$ :  $V_{Rk,c,II} = V_{Rk,b}$

3) The values are valid for steel 5.6 or higher. For steel 4.6 and 4.8 multiply  $V_{Rk,b}$  by 0,8

**Injection System VMU plus for masonry**

**Performance - Clay hollow brick HLz-16DF**

Group factor, Characteristic values of resistance

**Annex C19**

Brick type: Clay hollow brick HLz-16DF

**Table C47: Characteristic values of resistance under tension and shear loads (continue)**

Anchor size	Sleeve	Effective Anchorage depth	Characteristic resistance			
			Use category			
			d/d w/d w/w			d/d w/d w/w
			40°C/24°C	80°C/50°C	120°C/72°C	All temperature ranges
$h_{ef}$ [mm]	$N_{Rk,b} = N_{Rk,p}^{1)}$ [kN]			$V_{Rk,b}^{2)3)}$ [kN]		
<b>Compressive strength <math>f_b \geq 12 \text{ N/mm}^2</math></b>						
M8	12x80	80	3,5	3,5	3,0	4,0
M8 / M10/ IG-M6	16x85	85	3,5	3,5	3,0	6,5
	16x130	130	5,0	5,0	4,5	6,5
M12 / M16 / IG-M8 / IG-M10	20x85	85	3,5	3,5	3,0	7,0
	20x130	130	5,0	5,0	4,5	9,0
	20x200	200	5,0	5,0	4,5	9,0
<b>Compressive strength <math>f_b \geq 14 \text{ N/mm}^2</math></b>						
M8	12x80	80	4,0	4,0	3,0	4,0
M8 / M10/ IG-M6	16x85	85	4,0	4,0	3,0	6,5
	16x130	130	5,5	5,5	4,5	6,5
M12 / M16 / IG-M8 / IG-M10	20x85	85	4,0	4,0	3,0	7,0
	20x130	130	5,5	5,5	4,5	9,0
	20x200	200	5,5	5,5	4,5	9,0

1) Values are valid for  $c_{cr}$  and  $c_{min}$

2) Calculation of  $V_{Rk,c}$  see ETAG 029, Annex C, except for shear load parallel to free edge with  $c \geq 125 \text{ mm}$ :  $V_{Rk,c,II} = V_{Rk,b}$

3) The values are valid for steel 5.6 or higher. For steel 4.6 and 4.8 multiply  $V_{Rk,b}$  by 0,8

**Table C48: Displacements**

Anchor size	Sleeve	$h_{ef}$	N	$\delta_N / N$	$\delta_{N0}$	$\delta_{N\infty}$	V	$\delta_{V0}$	$\delta_{V\infty}$
		[mm]	[kN]	[mm/kN]	[mm]	[mm]	[kN]	[mm]	[mm]
M8	12x80	80	1,14	0,10	0,11	0,23	1,10	1,20	1,80
M8 / M10/ IG-M6	16x85	85					1,86	1,50	2,25
	16x130	130	1,57		1,50	2,25			
M12 / M16 / IG-M8 / IG-M10	20x85	85	1,14		0,11	0,23	1,86	1,50	2,25
	20x130	130	1,57		0,16	0,31	2,57	2,10	3,15
	20x200	200							

Injection System VMU plus for masonry

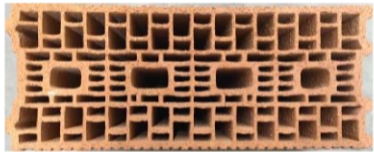
Performance - Clay hollow brick HLz-16DF

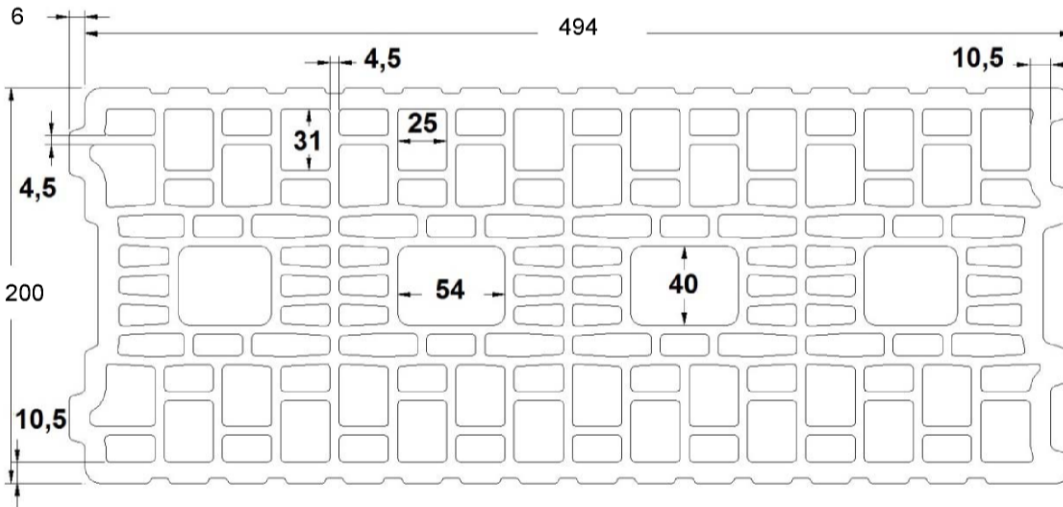
Characteristic values of resistance (continue), Displacements

Annex C20

**Brick type: Clay hollow brick Porotherm Homebric**

**Table C49: Description of the brick**

<b>Brick type</b>	Clay hollow brick Porotherm Homebric		
Bulk density	$\rho$ [kg/dm <sup>3</sup> ]	0,7	
Compressive strength	$f_b \geq$ [N/mm <sup>2</sup> ]	4, 6 or 10	
Code	EN 771-1		
Producer (country code)	e.g. Wienerberger (FR)		
Brick dimensions	[mm]	500 x 200 x 299	
Drilling method	Rotary		



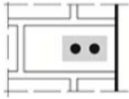
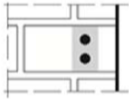
**Table C50: Spacing and edge distances**

Anchor size			All sizes
Edge distance	$c_{cr}$	[mm]	100 (120) <sup>1)</sup>
Minimum edge distance	$c_{min}$ <sup>2)</sup>	[mm]	100 (120) <sup>1)</sup>
Spacing	$s_{cr,II}$	[mm]	500
	$s_{cr,\perp}$	[mm]	299
Minimum spacing	$s_{min}$	[mm]	100

<sup>1)</sup> Value in brackets for VM-SH 20x85 and VM-SH 20x130

<sup>2)</sup> For  $V_{Rk,c}$ :  $c_{min}$  according to ETAG 029, Annex C

**Table C51: Group factor for anchor group in case of tension loading**

Configuration		with $c$ [mm] $\geq$	with $s$ [mm] $\geq$			
II: anchors placed parallel to horizontal joint		200	100	$\alpha_{g,N,II}$	[-]	2,0
		$c_{cr}$	500			2,0
⊥: anchors placed perpendicular to horizontal joint		200	100	$\alpha_{g,N,\perp}$		1,2
		$c_{cr}$	299			2,0

**Injection System VMU plus for masonry**

**Performance - Clay hollow brick Porotherm Homebric**

Description of the brick, Spacing and edge distances, Group factor

**Annex C21**

**Brick type: Clay hollow brick Porotherm Homebric**

**Table C52: Group factor for anchor group in case of shear loading parallel to free edge**

Configuration		with c [mm] ≥	with s [mm] ≥			
II: anchors placed parallel to horizontal joint		$C_{cr}$	500	$\alpha_{g,V,II}$	[-]	2,0
I: anchors placed perpendicular to horizontal joint		$C_{cr}$	299	$\alpha_{g,V,I}$		2,0

**Table C53: Group factor for anchor group in case of shear load perpendicular to free edge**

Configuration		with c [mm] ≥	with s [mm] ≥			
II: anchors placed parallel to horizontal joint		$C_{cr}$	500	$\alpha_{g,V,II}$	[-]	2,0
I: anchors placed perpendicular to horizontal joint		$C_{cr}$	299	$\alpha_{g,V,I}$		2,0

**Table C54: Characteristic values of resistance under tension and shear loads**

Anchor size	Sleeve	Effective Anchorage depth	Characteristic resistance			
			Use category			
			d/d w/d w/w			d/d w/d w/w
			40°C/24°C	80°C/50°C	120°C/72°C	All temperature ranges
$h_{ef}$	$N_{RK,b} = N_{RK,p}^{1)}$			$V_{RK,b}^{2)3)}$		
[mm]	[kN]			[kN]		
<b>Compressive strength <math>f_b \geq 4 \text{ N/mm}^2</math></b>						
M8	12x80	80	0,9	0,9	0,75	2,0
M8 / M10 / IG-M6	16x85	85	0,9	0,9	0,75	2,0
	16x130	130	1,2	1,2	0,9	2,0
M12 / M16 / IG-M8 / IG-M10	20x85	85	0,9	0,9	0,75	2,5
	20x130	130	1,2	1,2	0,9	2,5
<b>Compressive strength <math>f_b \geq 6 \text{ N/mm}^2</math></b>						
M8	12x80	80	0,9	0,9	0,9	2,5
M8 / M10 / IG-M6	16x85	85	0,9	0,9	0,9	2,5
	16x130	130	1,2	1,2	1,2	2,5
M12 / M16 / IG-M8 / IG-M10	20x85	85	0,9	0,9	0,9	3,0
	20x130	130	1,2	1,2	1,2	3,0

1) Values are valid for  $c_{cr}$  and  $c_{min}$

2) Calculation of  $V_{RK,c}$  see ETAG 029, Annex C, except for shear load parallel to free edge with  $c \geq 200 \text{ mm}$ :  $V_{RK,c,II} = V_{RK,b}$

3) The values are valid for steel 5.6 or higher. For steel 4.6 and 4.8 multiply  $V_{RK,b}$  by 0,8

**Injection System VMU plus for masonry**

**Annex C22**

**Performance - Clay hollow brick Porotherm Homebric**  
Group factor, Characteristic values of resistance

Brick type: Clay hollow brick Porotherm Homebric

**Table C55: Characteristic values of resistance under tension and shear loads (continue)**

Anchor size	Sleeve	Effective Anchorage depth	Characteristic resistance			
			Use category			
			d/d w/d w/w			d/d w/d w/w
			40°C/24°C	80°C/50°C	120°C/72°C	All temperature ranges
$h_{ef}$	$N_{Rk,b} = N_{Rk,p}^{1)}$			$V_{Rk,b}^{2)3)}$		
[mm]	[kN]			[kN]		
<b>Compressive strength <math>f_b \geq 10 \text{ N/mm}^2</math></b>						
M8	12x80	80	1,2	1,2	1,2	3,0
M8 / M10/ IG-M6	16x85	85	1,2	1,2	1,2	3,0
	16x130	130	1,5	1,5	1,5	3,5
M12 / M16 / IG-M8 / IG-M10	20x85	85	1,2	1,2	1,2	4,0
	20x130	130	1,5	1,5	1,5	4,0

1) Values are valid for  $c_{cr}$  and  $c_{min}$

2) Calculation of  $V_{Rk,c}$  see ETAG 029, Annex C, except for shear load parallel to free edge with  $c \geq 200 \text{ mm}$ :  $V_{Rk,c,II} = V_{Rk,b}$

3) The values are valid for steel 5.6 or higher. For steel 4.6 and 4.8 multiply  $V_{Rk,b}$  by 0,8

**Table C56: Displacements**

Anchor size	Sleeve	$h_{ef}$	N	$\delta_N / N$	$\delta_{N0}$	$\delta_{N\infty}$	V	$\delta_{V0}$	$\delta_{V\infty}$
		[mm]	[kN]	[mm/kN]	[mm]	[mm]	[kN]	[mm]	[mm]
M8	12x80	80	0,34	0,80	0,27	0,55	0,9	1,20	1,80
M8 / M10/ IG-M6	16x85	85					0,9		
	16x130	130	0,43		0,34	0,69	1,0		
M12 / M16 / IG-M8 / IG-M10	20x85	85	0,34		0,27	0,55	1,14		
	20x130	130	0,43	0,34	0,69				

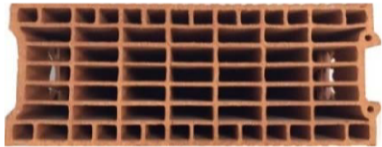
Injection System VMU plus for masonry

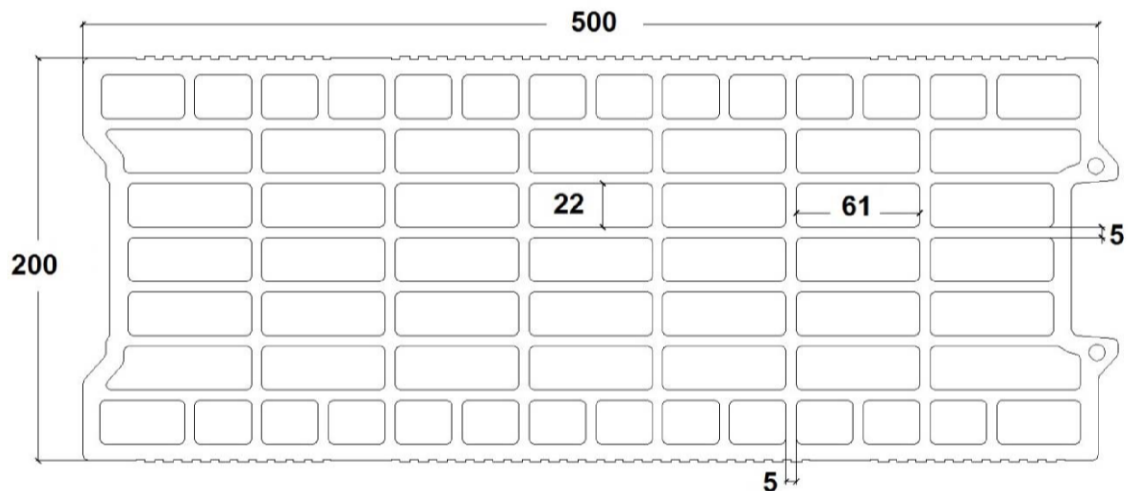
**Performance - Clay hollow brick Porotherm Homebric**  
Characteristic values of resistance (continue), Displacements

**Annex C23**

## Brick type: Clay hollow brick BGV Thermo

**Table C57: Description of the brick**

<b>Brick type</b>	Clay hollow brick BGV Thermo		
Bulk density	$\rho$ [kg/dm <sup>3</sup> ]	0,6	
Compressive strength	$f_b \geq$ [N/mm <sup>2</sup> ]	4, 6 or 10	
Code	EN 771-1		
Producer (country code)	e.g. Leroux (FR)		
Brick dimensions	[mm]	500 x 200 x 314	
Drilling method	Rotary		



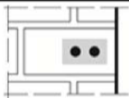
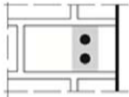
**Table C58: Spacing and edge distances**

Anchor size			All sizes
Edge distance	$C_{cr}$	[mm]	100 (120) <sup>1)</sup>
Minimum edge distance	$C_{min}$ <sup>2)</sup>	[mm]	100 (120) <sup>1)</sup>
Spacing	$S_{cr,II}$	[mm]	500
	$S_{cr,\perp}$	[mm]	314
Minimum spacing	$S_{min}$	[mm]	100

1) Values in brackets for VM-SH 20x85 and VM-SH 20x130

2) For  $V_{Rk,c}$ :  $C_{min}$  according to ETAG 029, Annex C

**Table C59: Group factor for anchor group in case of tension loading**

Configuration		with $c$ [mm] $\geq$	with $s$ [mm] $\geq$			
II: anchors placed parallel to horizontal joint		200	100	$\alpha_{g,N,II}$	[-]	1,7
		$C_{cr}$	500			2,0
⊥: anchors placed perpendicular to horizontal joint		200	100	$\alpha_{g,N,\perp}$	[-]	1,1
		$C_{cr}$	314			2,0

### Injection System VMU plus for masonry

### Performance - Clay hollow brick BGV Thermo

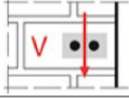
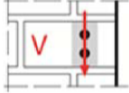
Description of the brick, Spacing and edge distances, Group factor

**Annex C24**

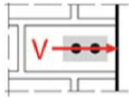
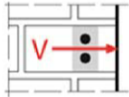


**Brick type: Clay hollow brick BGV Thermo**

**Table C60: Group factor for anchor group in case of shear loading parallel to free edge**

Configuration		with $c$ [mm] $\geq$	with $s$ [mm] $\geq$			
II: anchors placed parallel to horizontal joint		$C_{cr}$	500	$\alpha_{g,V,II}$	[-]	2,0
I: anchors placed perpendicular to horizontal joint		$C_{cr}$	314	$\alpha_{g,V,I}$		2,0

**Table C61: Group factor for anchor group in case of shear load perpendicular to free edge**

Configuration		with $c$ [mm] $\geq$	with $s$ [mm] $\geq$			
II: anchors placed parallel to horizontal joint		$C_{cr}$	500	$\alpha_{g,V,II}$	[-]	2,0
I: anchors placed perpendicular to horizontal joint		$C_{cr}$	314	$\alpha_{g,V,I}$		2,0

**Injection System VMU plus for masonry**

**Performance - Clay hollow brick BGV Thermo**  
Group factor

**Annex C25**

**Brick type: Clay hollow brick BGV Thermo**

**Table C62: Characteristic values of resistance under tension and shear loads**

Anchor size	Sleeve	Effective Anchorage depth	Characteristic resistance			
			Use category			
			d/d w/d w/w			d/d w/d w/w
			40°C/24°C	80°C/50°C	120°C/72°C	All temperature ranges
$h_{ef}$ [mm]	$N_{Rk,b} = N_{Rk,p}^{1)}$ [kN]			$V_{Rk,b}^{2)3)}$ [kN]		
<b>Compressive strength <math>f_b \geq 4 \text{ N/mm}^2</math></b>						
M8	12x80	80	0,6	0,6	0,6	2,0
M8 / M10/ IG-M6	16x85	85	0,6	0,6	0,6	2,0
	16x130	130	1,2	1,2	0,9	2,5
M12 / M16 / IG-M8 / IG-M10	20x85	85	0,6	0,6	0,6	2,5
	20x130	130	1,2	1,2	0,9	2,5
<b>Compressive strength <math>f_b \geq 6 \text{ N/mm}^2</math></b>						
M8	12x80	80	0,9	0,9	0,75	2,5
M8 / M10/ IG-M6	16x85	85	0,9	0,9	0,75	2,5
	16x130	130	1,5	1,5	1,2	3,0
M12 / M16 / IG-M8 / IG-M10	20x85	85	0,9	0,9	0,75	3,0
	20x130	130	1,5	1,5	1,2	3,0
<b>Compressive strength <math>f_b \geq 10 \text{ N/mm}^2</math></b>						
M8	12x80	80	0,9	0,9	0,9	3,5
M8 / M10/ IG-M6	16x85	85	0,9	0,9	0,9	3,5
	16x130	130	2,0	2,0	1,5	4,0
M12 / M16 / IG-M8 / IG-M10	20x85	85	0,9	0,9	0,9	4,0
	20x130	130	2,0	2,0	1,5	4,0

1) Values are valid for  $c_{cr}$  and  $c_{min}$

2) Calculation of  $V_{Rk,c}$  see ETAG 029, Annex C, except for shear load parallel to free edge with  $c \geq 250 \text{ mm}$ :  $V_{Rk,c,II} = V_{Rk,b}$

3) The values are valid for steel 5.6 or higher. For steel 4.6 and 4.8 multiply  $V_{Rk,b}$  by 0,8

**Table C63: Displacements**

Anchor size	Sleeve	$h_{ef}$	N	$\delta_N / N$	$\delta_{N0}$	$\delta_{N\infty}$	V	$\delta_{V0}$	$\delta_{V\infty}$
		[mm]	[kN]	[mm/kN]	[mm]	[mm]	[kN]	[mm]	[mm]
M8	12x80	80	0,26	0,80	0,21	0,41	0,7	1,00	1,50
M8 / M10/ IG-M6	16x85	85							
	16x130	130	0,43		0,34	0,69	0,86		
M12 / M16 / IG-M8 / IG-M10	20x85	85	0,26		0,21	0,41			
	20x130	130	0,43	0,34	0,69				


**Injection System VMU plus for masonry**

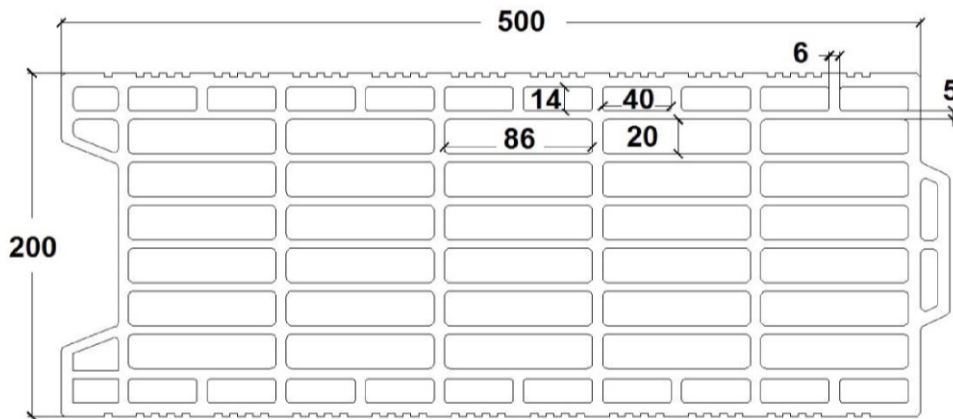
**Performance - Clay hollow brick BGV Thermo**  
Characteristic values of resistance, Displacements

**Annex C26**

**Brick type: Clay hollow brick Calibric R+**

**Table C64: Description of the brick**

<b>Brick type</b>	Clay hollow brick Calibric R+		
Bulk density	$\rho$ [kg/dm <sup>3</sup> ]	0,6	
Compressive strength	$f_b \geq$ [N/mm <sup>2</sup> ]	6, 9 or 12	
Code	EN 771-1		
Producer (country code)	e.g. Terreal (FR)		
Brick dimensions	[mm]	500 x 200 x 314	
Drilling method	Rotary		



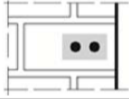
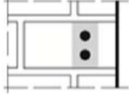
**Table C65: Spacing and edge distances**

Anchor size			All sizes
Edge distance	$c_{cr}$	[mm]	100 (120) <sup>1)</sup>
Minimum edge distance	$c_{min}$ <sup>2)</sup>	[mm]	100 (120) <sup>1)</sup>
Spacing	$s_{cr,II}$	[mm]	500
	$s_{cr,\perp}$	[mm]	314
Minimum spacing	$s_{min}$	[mm]	100

<sup>1)</sup> Value in brackets for VM-SH 20x85 and VM-SH 20x130

<sup>2)</sup> For  $V_{Rk,c}$ :  $c_{min}$  according to ETAG 029, Annex C

**Table C66: Group factor for anchor group in case of tension loading**

Configuration		with $c$ [mm] $\geq$	with $s$ [mm] $\geq$			
II: anchors placed parallel to horizontal joint		175	100	$\alpha_{g,N,II}$	[-]	1,7
		$c_{cr}$	500			2,0
⊥: anchors placed perpendicular to horizontal joint		175	100	$\alpha_{g,N,\perp}$		1,0
		$c_{cr}$	314			2,0

**Injection System VMU plus for masonry**

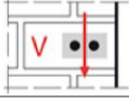
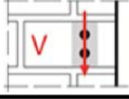
**Annex C27**

**Performance - Clay hollow brick Calibric R+**

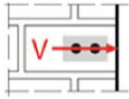
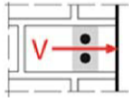
Description of the brick, Spacing and edge distances, Group factor

**Brick type: Clay hollow brick Calibric R+**

**Table C67: Group factor for anchor group in case of shear loading parallel to free edge**

Configuration		with c [mm] ≥	with s [mm] ≥			
II: anchors placed parallel to horizontal joint		$C_{cr}$	500	$\alpha_{g,V,II}$	[-]	2,0
I: anchors placed perpendicular to horizontal joint		$C_{cr}$	314	$\alpha_{g,V,I}$		2,0

**Table C68: Group factor for anchor group in case of shear load perpendicular to free edge**

Configuration		with c [mm] ≥	with s [mm] ≥			
II: anchors placed parallel to horizontal joint		$C_{cr}$	500	$\alpha_{g,V,II}$	[-]	2,0
I: anchors placed perpendicular to horizontal joint		$C_{cr}$	314	$\alpha_{g,V,I}$		2,0

**Table C69: Characteristic values of resistance under tension and shear loads**

Anchor size	Sleeve	Effective Anchorage depth	Characteristic resistance			
			Use category			
			d/d		d/d	
			w/d	w/d	w/w	w/w
		40°C/24°C	80°C/50°C	120°C/72°C	All temperature ranges	
		$h_{ef}$	$N_{RK,b} = N_{RK,p}^{1)}$		$V_{RK,b}^{2)3)}$	
		[mm]	[kN]		[kN]	
<b>Compressive strength <math>f_b \geq 6 \text{ N/mm}^2</math></b>						
M8	12x80	80	0,9	0,9	0,75	3,0
M8 / M10 / IG-M6	16x85	85	0,9	0,9	0,75	4,0
	16x130	130	1,2	1,2	0,9	4,0
M12 / M16 / IG-M8 / IG-M10	20x85	85	0,9	0,9	0,75	6,0
	20x130	130	1,2	1,2	0,9	6,0
<b>Compressive strength <math>f_b \geq 9 \text{ N/mm}^2</math></b>						
M8	12x80	80	1,2	1,2	0,9	3,5
M8 / M10 / IG-M6	16x85	85	1,2	1,2	0,9	5,0
	16x130	130	1,5	1,5	1,2	5,0
M12 / M16 / IG-M8 / IG-M10	20x85	85	1,2	1,2	0,9	7,5
	20x130	130	1,5	1,5	1,2	7,5

1) Values are valid for  $c_{cr}$  and  $c_{min}$

2) Calculation of  $V_{RK,c}$  see ETAG 029, Annex C, except for shear load parallel to free edge with  $c \geq 250 \text{ mm}$ :  $V_{RK,c,II} = V_{RK,b}$

3) The values are valid for steel 5.6 or higher. For steel 4.6 and 4.8 multiply  $V_{RK,b}$  by 0,8

**Injection System VMU plus for masonry**

**Performance - Clay hollow brick Calibric R+**  
Group factor, Characteristic values of resistance

**Annex C28**

**Brick type: Clay hollow brick Calibric R+**

**Table C70: Characteristic values of resistance under tension and shear load (continue)**

Anchor size	Sleeve	Effective Anchorage depth	Characteristic resistance			
			Use category			
			d/d w/d w/w			d/d w/d w/w
			40°C/24°C	80°C/50°C	120°C/72°C	All temperature ranges
$h_{ef}$	$N_{Rk,b} = N_{Rk,p}^{1)}$			$V_{Rk,b}^{2)3)}$		
[mm]	[kN]			[kN]		
<b>Compressive strength <math>f_b \geq 12 \text{ N/mm}^2</math></b>						
M8	12x80	80	1,2	1,2	0,9	4,0
M8 / M10/ IG-M6	16x85	85	1,2	1,2	0,9	5,5
	16x130	130	1,5	1,5	1,2	5,5
M12 / M16 / IG-M8 / IG-M10	20x85	85	1,2	1,2	0,9	8,5
	20x130	130	1,5	1,5	1,2	8,5

- 1) Values are valid for  $c_{cr}$  and  $c_{min}$
- 2) Calculation of  $V_{Rk,c}$  see ETAG 029, Annex C, except for shear load parallel to free edge with  $c \geq 250 \text{ mm}$ :  $V_{Rk,c,II} = V_{Rk,b}$
- 3) The values are valid for steel 5.6 or higher. For steel 4.6 and 4.8 multiply  $V_{Rk,b}$  by 0,8

**Table C71: Displacements**

Anchor size	Sleeve	$h_{ef}$	N	$\delta_N / N$	$\delta_{N0}$	$\delta_{N\infty}$	V	$\delta_{V0}$	$\delta_{V\infty}$
		[mm]	[kN]	[mm/kN]	[mm]	[mm]	[kN]	[mm]	[mm]
M8	12x80	80	0,34	0,80	0,27	0,55	1,0	1,10	1,65
M8 / M10/ IG-M6	16x85	85					1,43		
	16x130	130	0,43		0,34	0,69			
M12 / M16 / IG-M8 / IG-M10	20x85	85	0,34		0,27	0,55	2,14	2,0	3,0
	20x130	130	0,43		0,34	0,69			


**Injection System VMU plus for masonry**

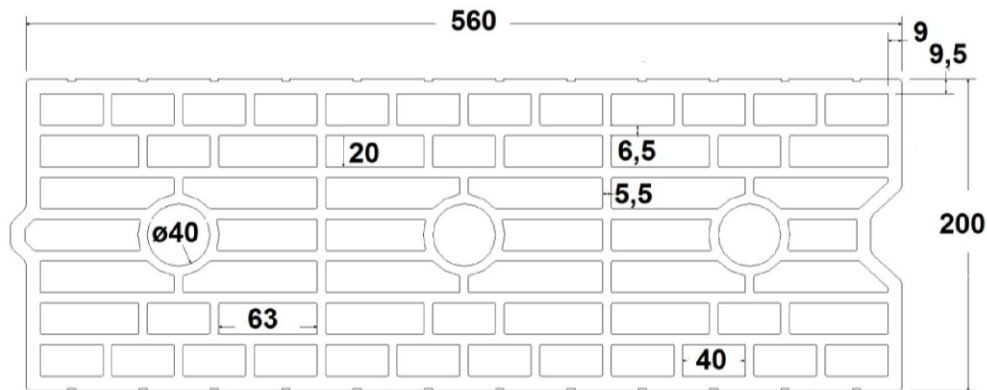
**Performance - Clay hollow brick Calibric R+**  
Characteristic values of resistance, Displacements

**Annex C29**

## Brick type: Clay hollow brick Urbanbric

**Table C72: Description of the brick**

<b>Brick type</b>	Clay hollow brick Urbanbric		
Bulk density	$\rho$ [kg/dm <sup>3</sup> ]	0,7	
Compressive strength	$f_b \geq$ [N/mm <sup>2</sup> ]	6, 9 or 12	
Code	EN 771-1		
Producer (country code)	e.g. Imerys (FR)		
Brick dimensions	[mm]	560 x 200 x 274	
Drilling method	Rotary		



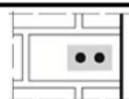
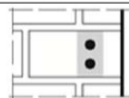
**Table C73: Spacing and edge distances**

Anchor size			All sizes
Edge distance	$C_{cr}$	[mm]	100 (120) <sup>1)</sup>
Minimum edge distance	$C_{min}$ <sup>2)</sup>	[mm]	100 (120) <sup>1)</sup>
Spacing	$S_{cr,II}$	[mm]	560
	$S_{cr,\perp}$	[mm]	274
Minimum spacing	$S_{min}$	[mm]	100

<sup>1)</sup> Value in brackets for VM-SH 20x85 and VM-SH 20x130

<sup>2)</sup> For  $V_{Rk,c}$ :  $C_{min}$  according to ETAG 029, Annex C

**Table C74: Group factor for anchor group in case of tension loading**

Configuration		with $c$ [mm] $\geq$	with $s$ [mm] $\geq$			
II: anchors placed parallel to horizontal joint		185	100	$\alpha_{g,N,II}$	[-]	1,9
		$C_{cr}$	560			2,0
⊥: anchors placed perpendicular to horizontal joint		185	100	$\alpha_{g,N,\perp}$	[-]	1,1
		$C_{cr}$	274			2,0

### Injection System VMU plus for masonry

### Performance - Clay hollow brick Urbanbric

Description of the brick, Spacing and edge distances, Group factor

**Annex C30**

**Brick type: Clay hollow brick Urbanbric**

**Table C75: Group factor for anchor group in case of shear loading parallel to free edge**

Configuration		with $c$ [mm] $\geq$	with $s$ [mm] $\geq$			
II: anchors placed parallel to horizontal joint		$C_{cr}$	560	$\alpha_{g,V,II}$	[-]	2,0
I: anchors placed perpendicular to horizontal joint		$C_{cr}$	274	$\alpha_{g,V,I}$		2,0

**Table C76: Group factor for anchor groups in case of shear load perpendicular to free edge**

Configuration		with $c$ [mm] $\geq$	with $s$ [mm] $\geq$			
II: anchors placed parallel to horizontal joint		$C_{cr}$	560	$\alpha_{g,V,II}$	[-]	2,0
I: anchors placed perpendicular to horizontal joint		$C_{cr}$	274	$\alpha_{g,V,I}$		2,0

**Table C77: Characteristic values of resistance under tension and shear load**

Anchor size	Sleeve	Effective Anchorage depth	Characteristic resistance			
			Use category			
			d/d		d/d	
			w/d	w/d	w/w	w/w
		40°C/24°C	80°C/50°C	120°C/72°C	All temperature ranges	
		$h_{ef}$	$N_{RK,b} = N_{RK,p}^{1)}$		$V_{RK,b}^{2)3)}$	
		[mm]	[kN]		[kN]	
<b>Compressive strength <math>f_b \geq 6 \text{ N/mm}^2</math></b>						
M8	12x80	80	0,9	0,9	0,75	3,0
M8 / M10 / IG-M6	16x85	85	0,9	0,9	0,75	3,0
	16x130	130	2,0	2,0	1,5	3,0
M12 / M16 / IG-M8 / IG-M10	20x85	85	0,9	0,9	0,75	3,5
	20x130	130	2,0	2,0	1,5	3,5
<b>Compressive strength <math>f_b \geq 9 \text{ N/mm}^2</math></b>						
M8	12x80	80	0,9	0,9	0,9	4,0
M8 / M10 / IG-M6	16x85	85	0,9	0,9	0,9	4,0
	16x130	130	2,5	2,5	2,0	4,0
M12 / M16 / IG-M8 / IG-M10	20x85	85	0,9	0,9	0,9	4,5
	20x130	130	2,5	2,5	2,0	4,5

1) Values are valid for  $c_{cr}$  and  $c_{min}$

2) Calculation of  $V_{RK,c}$  see ETAG 029, Annex C, except for shear load parallel to free edge with  $c \geq 190 \text{ mm}$ :  $V_{RK,c,II} = V_{RK,b}$

3) The values are valid for steel 5.6 or higher. For steel 4.6 and 4.8 multiply  $V_{RK,b}$  by 0,8

**Injection System VMU plus for masonry**

**Annex C31**

**Performance - Clay hollow brick Urbanbric**  
Group factor, Characteristic values of resistance

**Brick type: Clay hollow brick Urbanbric**

**Table C78: Characteristic values of resistance under tension and shear load (continue)**

Anchor size	Sleeve	Effective Anchorage depth	Characteristic resistance			
			Use category			
			d/d w/d w/w			d/d w/d w/w
			40°C/24°C	80°C/50°C	120°C/72°C	All temperature ranges
$h_{ef}$	$N_{Rk,b} = N_{Rk,p}^{1)}$			$V_{Rk,b}^{2)3)}$		
[mm]	[kN]			[kN]		
<b>Compressive strength <math>f_b \geq 12 \text{ N/mm}^2</math></b>						
M8	12x80	80	1,2	1,2	0,9	4,5
M8 / M10/ IG-M6	16x85	85	1,2	1,2	0,9	4,5
	16x130	130	3,0	3,0	2,5	4,5
M12 / M16 / IG-M8 / IG-M10	20x85	85	1,2	1,2	0,9	5,0
	20x130	130	3,0	3,0	2,5	5,0

1) Values are valid for  $c_{cr}$  and  $c_{min}$

2) Calculation of  $V_{Rk,c}$  see ETAG 029, Annex C, except for shear load parallel to free edge with  $c \geq 190 \text{ mm}$ :  $V_{Rk,c,II} = V_{Rk,b}$

3) The values are valid for steel 5.6 or higher. For steel 4.6 and 4.8 multiply  $V_{Rk,b}$  by 0,8

**Table C79: Displacements**

Anchor size	Sleeve	$h_{ef}$	N	$\delta_N / N$	$\delta_{N0}$	$\delta_{N\infty}$	V	$\delta_{V0}$	$\delta_{V\infty}$
		[mm]	[kN]	[mm/kN]	[mm]	[mm]	[kN]	[mm]	[mm]
M8	12x80	80	0,34	0,80	0,27	0,55	1,30	1,00	1,50
M8 / M10/ IG-M6	16x85	85			0,69	1,37			
	16x130	130	0,27		0,55				
M12 / M16 / IG-M8 / IG-M10	20x85	85	0,34		0,69	1,37	1,43		
	20x130	130	0,86						

**Injection System VMU plus for masonry**


**Performance - Clay hollow brick Urbanbric**  
Characteristic values of resistance, Displacements

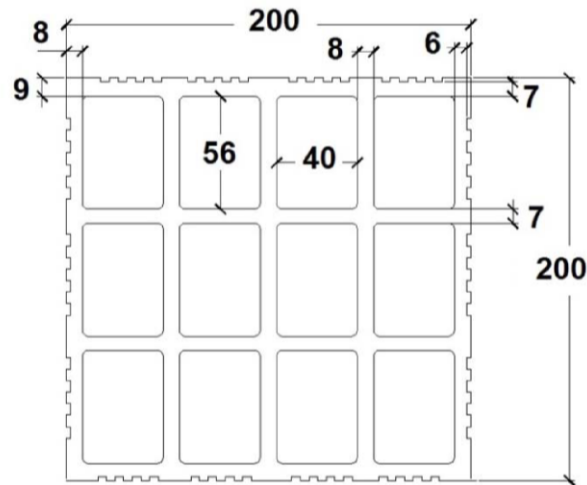
**Annex C32**



## Brick type: Clay hollow brick Brique creuse C40

**Table C80: Description of the brick**

<b>Brick type</b>	Clay hollow brick Brique creuse C40		
Bulk density	$\rho$ [kg/dm <sup>3</sup> ]	0,7	
Compressive strength	$f_b \geq$ [N/mm <sup>2</sup> ]	4, 8 or 12	
Code	EN 771-1		
Producer (country code)	e.g. Terreal (FR)		
Brick dimensions	[mm]	500 x 200 x 200	
Drilling method	Rotary		



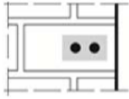
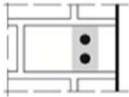
**Table C81: Spacing and edge distances**

Anchor size			All sizes
Edge distance	$c_{cr}$	[mm]	100 (120) <sup>1)</sup>
Minimum edge distance	$c_{min}$ <sup>2)</sup>	[mm]	100 (120) <sup>1)</sup>
Spacing	$s_{cr,II}$	[mm]	500
	$s_{cr,\perp}$	[mm]	200
Minimum spacing	$s_{min}$	[mm]	200

<sup>1)</sup> Values in brackets for VM-SH 20x85 and VM-SH 20x130

<sup>2)</sup> For  $V_{Rk,c}$ :  $c_{min}$  according to ETAG 029, Annex C

**Table C82: Group factor for anchor group in case of tension loading**

Configuration		with $c$ [mm] $\geq$	with $s$ [mm] $\geq$			
II: anchors placed parallel to horizontal joint		$c_{cr}$	200	$\alpha_{g,N,II}$	[-]	2,0
I: anchors placed perpendicular to horizontal joint		$c_{cr}$	200	$\alpha_{g,N,\perp}$		2,0

### Injection System VMU plus for masonry

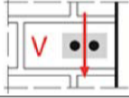
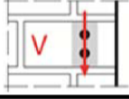
#### Performance - Clay hollow brick Brique creuse C40

Description of the brick, Spacing and edge distances, Group factor

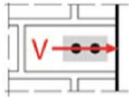
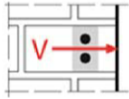
**Annex C33**

**Brick type: Clay hollow brick Brique creuse C40**

**Table C83: Group factor for anchor group in case of shear loading parallel to free edge**

Configuration		with c [mm] ≥	with s [mm] ≥			
II: anchors placed parallel to horizontal joint		$C_{cr}$	500	$\alpha_{g,V,II}$	[-]	2,0
I: anchors placed perpendicular to horizontal joint		$C_{cr}$	200	$\alpha_{g,V,I}$		2,0

**Table C84: Group factor for anchor group in case of shear load perpendicular to free edge**

Configuration		with c [mm] ≥	with s [mm] ≥			
II: anchors placed parallel to horizontal joint		$C_{cr}$	500	$\alpha_{g,V,II}$	[-]	2,0
I: anchors placed perpendicular to horizontal joint		$C_{cr}$	200	$\alpha_{g,V,I}$		2,0

**Table C85: Characteristic values of resistance under tension and shear load**

Anchor size	Sleeve	Effective Anchorage depth	Characteristic resistance			
			Use category			
			d/d w/d w/w			d/d w/d w/w
			40°C/24°C	80°C/50°C	120°C/72°C	All temperature ranges
$h_{ef}$	$N_{RK,b} = N_{RK,p}^{1)}$			$V_{RK,b}^{2)3)}$		
[mm]	[kN]			[kN]		
<b>Compressive strength <math>f_b \geq 4 \text{ N/mm}^2</math></b>						
M8	12x80	80	0,6	0,6	0,6	0,9
M8 / M10/ IG-M6	16x85	85				
	16x130	130				
M12 / M16 / IG-M8 / IG-M10	20x85	85				
	20x130	130				
<b>Compressive strength <math>f_b \geq 8 \text{ N/mm}^2</math></b>						
M8	12x80	80	0,9	0,9	0,75	1,2
M8 / M10/ IG-M6	16x85	85				
	16x130	130				
M12 / M16 / IG-M8 / IG-M10	20x85	85				
	20x130	130				

1) Values are valid for  $c_{cr}$  and  $c_{min}$

2) Calculation of  $V_{RK,c}$  see ETAG 029, Annex C

3) The values are valid for steel 5.6 or higher. For steel 4.6 and 4.8 multiply  $V_{RK,b}$  by 0,8

**Injection System VMU plus for masonry**

**Annex C34**

**Performance - Clay hollow brick Brique creuse C40**

Group factor, Characteristic values of resistance

**Brick type: Clay hollow brick Brique creuse C40**

**Table C86: Characteristic values of resistance under tension and shear load (continue)**

Anchor size	Sleeve	Effective Anchorage depth	Characteristic resistance			
			Use category			
			d/d w/d w/w			d/d w/d w/w
			40°C/24°C	80°C/50°C	120°C/72°C	All temperature ranges
$h_{ef}$	$N_{Rk,b} = N_{Rk,p}^{1)}$			$V_{Rk,b}^{2)3)}$		
[mm]	[kN]			[kN]		
<b>Compressive strength <math>f_b \geq 12 \text{ N/mm}^2</math></b>						
M8	12x80	80	1,2	1,2	0,9	1,5
M8 / M10/ IG-M6	16x85	85				
	16x130	130				
M12 / M16 / IG-M8 / IG-M10	20x85	85				
	20x130	130				

1) Values are valid for  $c_{cr}$  and  $c_{min}$

2) Calculation of  $V_{Rk,c}$  see ETAG 029, Annex C

3) The values are valid for steel 5.6 or higher. For steel 4.6 and 4.8 multiply  $V_{Rk,b}$  by 0,8

**Table C87: Displacements**

Anchor size	Sleeve	$h_{ef}$	N	$\delta_N / N$	$\delta_{N0}$	$\delta_{N\infty}$	V	$\delta_{V0}$	$\delta_{V\infty}$
		[mm]	[kN]	[mm/kN]	[mm]	[mm]	[kN]	[mm]	[mm]
M8	12x80	80	0,17	0,80	0,14	0,27	0,3	0,9	1,35
M8 / M10/ IG- M6	16x85	85							
	16x130	130	0,14		0,11	0,23			
M12 / M16 / IG-M8 / IG-M10	20x85	85	0,17		0,14	0,27			
	20x130	130	0,14	0,11	0,23				


**Injection System VMU plus for masonry**

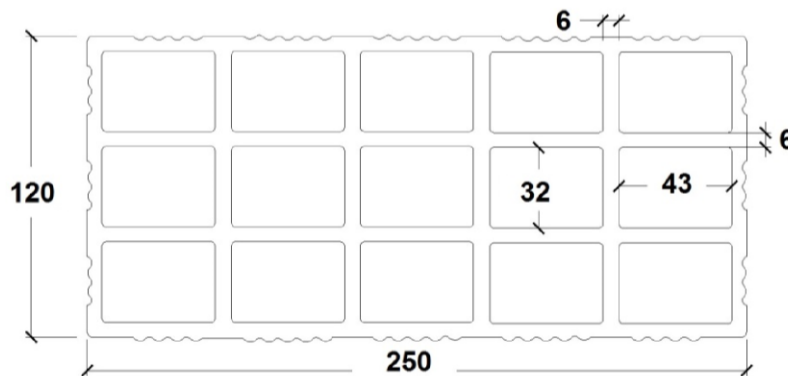
**Performance - Clay hollow brick Brique creuse C40**  
Characteristic values of resistance, Displacements

**Annex C35**

## Brick type: Clay hollow brick Blocchi Leggeri

**Table C88: Description of the brick**

<b>Brick type</b>	Clay hollow brick Blocchi Leggeri		
Bulk density	$\rho$ [kg/dm <sup>3</sup> ]	0,6	
Compressive strength	$f_b \geq$ [N/mm <sup>2</sup> ]	4, 6, 8 or 12	
Code	EN 771-1		
Producer (country code)	e.g. Wienerberger (IT)		
Brick dimensions	[mm]	250 x 120 x 250	
Drilling method	Rotary		

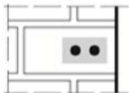
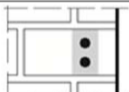


**Table C89: Spacing and edge distances**

Anchor size			All sizes
Edge distance	$c_{cr}$	[mm]	100 (120) <sup>1)</sup>
Minimum edge distance	$c_{min}$	[mm]	60
Spacing	$s_{cr,II}$	[mm]	250
	$s_{cr,\perp}$	[mm]	120
Minimum spacing	$s_{min}$	[mm]	100

<sup>1)</sup> Value in brackets for VM-SH 20x85; VM-SH 20x130 and VM-SH 20x200

**Table C90: Group factor for anchor group in case of tension loading**

Configuration		with $c$ [mm] $\geq$	with $s$ [mm] $\geq$			
II: anchors placed parallel to horizontal joint		60	100	$\alpha_{g,N,II}$	[-]	1,0
		$c_{cr}$	250			2,0
I: anchors placed perpendicular to horizontal joint		60	100	$\alpha_{g,N,\perp}$		2,0

### Injection System VMU plus for masonry

### Annex C36

#### Performance - Clay hollow brick Blocchi Leggeri

Description of the brick, Spacing and edge distances, Group factor

**Brick type: Clay hollow brick Blocchi Leggeri**

**Table C91: Group factor for anchor group in case of shear loading parallel to free edge**

Configuration		with c [mm] ≥	with s [mm] ≥			
II: anchors placed parallel to horizontal joint		60 <sup>1)</sup>	100 <sup>1)</sup>	$\alpha_{g,V,II}$	[-]	1,0
		$c_{cr}$	250			2,0
I: anchors placed perpendicular to horizontal joint		60 <sup>1)</sup>	100 <sup>1)</sup>	$\alpha_{g,V,I}$		1,6
		$c_{cr}$	250			2,0

<sup>1)</sup> Only valid for  $V_{Rk,b}$  according to Table C93 and C94 values in brackets

**Table C92: Group factor for anchor group in case of shear load perpendicular to free edge**

Configuration		with c [mm] ≥	with s [mm] ≥			
II: anchors placed parallel to horizontal joint		60 <sup>1)</sup>	100 <sup>1)</sup>	$\alpha_{g,V,II}$	[-]	1,0
		$c_{cr}$	250			2,0
I: anchors placed perpendicular to horizontal joint		60 <sup>1)</sup>	100 <sup>1)</sup>	$\alpha_{g,V,I}$		1,6
		$c_{cr}$	250			2,0

<sup>1)</sup> Only valid for  $V_{Rk,b}$  according to Table C93 and C94 values in brackets

**Table C93: Characteristic values of resistance under tension and shear load**

Anchor size	Sleeve	Effective Anchorage depth	Characteristic resistance			
			Use category			d/d w/d w/w
			40°C/24°C	80°C/50°C	120°C/72°C	
			$h_{ef}$ [mm]	$N_{Rk,b} = N_{Rk,p}$ <sup>1)</sup>		
[kN]						
<b>Compressive strength <math>f_b \geq 4 \text{ N/mm}^2</math></b>						
M8	12x80	80	0,4	0,4	0,3	2,0 <sup>2)</sup> (0,9) <sup>3)</sup>
M8 / M10/ IG-M6	16x85	85				
	16x130	130				
M12 / M16 / IG-M8 / IG-M10	20x85	85				
	20x130	130				
	20x200	200				

1) Values are valid for  $c_{cr}$  and  $c_{min}$

2) Calculation of  $V_{Rk,c}$  see ETAG 029, Annex C, except for shear load parallel to free edge with  $c \geq 125 \text{ mm}$ :  $V_{Rk,c,II} = V_{Rk,b}$

3) Values in brackets  $V_{Rk,c} = V_{Rk,b}$  for anchors with  $c_{min}$

4) The values are valid for steel 5.6 or higher. For steel 4.6 and 4.8 multiply  $V_{Rk,b}$  by 0,8

**Injection System VMU plus for masonry**

**Annex C37**

**Performance - Clay hollow brick Blocchi Leggeri**  
Group factor, Characteristic values of resistance

**Brick type: Clay hollow brick Blocchi Leggeri**

**Table C94: Characteristic values of resistance under tension and shear load (continue)**

Anchor size	Sleeve	Effective Anchorage depth	Characteristic resistance			
			Use category			
			d/d w/d w/w			d/d w/d w/w
			40°C/24°C	80°C/50°C	120°C/72°C	All temperature ranges
$h_{ef}$	$N_{Rk,b} = N_{Rk,p}^{1)}$			$V_{Rk,b}^{4)}$		
[mm]	[kN]			[kN]		
<b>Compressive strength <math>f_b \geq 6 \text{ N/mm}^2</math></b>						
M8	12x80	80	0,5	0,5	0,4	2,5 <sup>2)</sup> (1,2) <sup>3)</sup>
M8 / M10/ IG-M6	16x85	85				
	16x130	130				
M12 / M16 / IG-M8 / IG-M10	20x85	85				
	20x130	130				
	20x200	200				
<b>Compressive strength <math>f_b \geq 8 \text{ N/mm}^2</math></b>						
M8	12x80	80	0,6	0,6	0,5	3,0 <sup>2)</sup> (1,2) <sup>3)</sup>
M8 / M10/ IG-M6	16x85	85				
	16x130	130				
M12 / M16 / IG-M8 / IG-M10	20x85	85				
	20x130	130				
	20x200	200				
<b>Compressive strength <math>f_b \geq 12 \text{ N/mm}^2</math></b>						
M8	12x80	80	0,6	0,6	0,6	3,5 <sup>2)</sup> (1,5) <sup>3)</sup>
M8 / M10/ IG-M6	16x85	85				
	16x130	130				
M12 / M16 / IG-M8 / IG-M10	20x85	85				
	20x130	130				
	20x200	200				

- 1) Values are valid for  $c_{cr}$  and  $c_{min}$
- 2) Calculation of  $V_{Rk,c}$  see ETAG 029, Annex C, except for shear load parallel to free edge with  $c \geq 125 \text{ mm}$ :  $V_{Rk,c,II} = V_{Rk,b}$
- 3) Values in brackets  $V_{Rk,c} = V_{Rk,b}$  for anchors with  $c_{min}$
- 4) The values are valid for steel 5.6 or higher. For steel 4.6 and 4.8 multiply  $V_{Rk,b}$  by 0,8

**Table C95: Displacements**

Anchor size	Sleeve	$h_{ef}$	N	$\delta_N / N$	$\delta_{N0}$	$\delta_{N\infty}$	V	$\delta_{V0}$	$\delta_{V\infty}$
		[mm]	[kN]	[mm/kN]	[mm]	[mm]	[kN]	[mm]	[mm]
All sizes	All sizes	All sizes	0,17	1,20	0,21	0,41	0,9	1,20	1,80

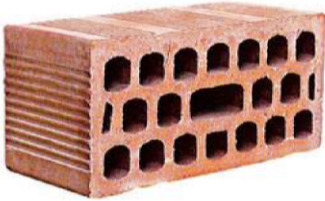
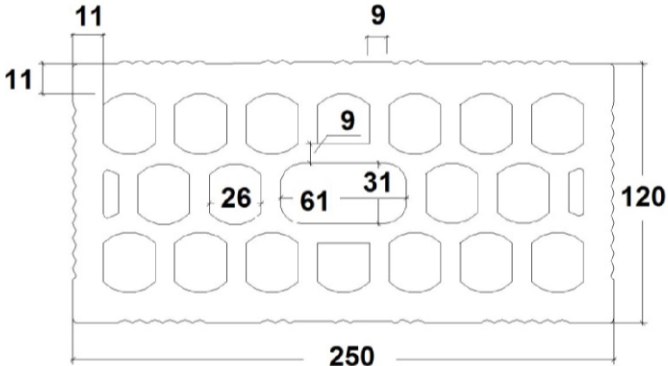
**Injection System VMU plus for masonry**

**Performance - Clay hollow brick Blocchi Leggeri**  
Characteristic values of resistance, Displacements

**Annex C38**

## Brick type: Clay hollow brick Doppio Uni

**Table C96: Description of the brick**

<b>Brick type</b>	Clay hollow brick Doppio Uni		
Bulk density $\rho$ [kg/dm <sup>3</sup> ]	0,9		
Compressive strength $f_b \geq$ [N/mm <sup>2</sup> ]	10, 16, 20 or 28		
Code	EN 771-1		
Producer (country code)	e.g. Wienerberger (IT)		
Brick dimensions [mm]	250 x 120 x 120		
Drilling method	Rotary		
			

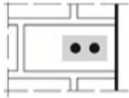
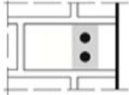
**Table C97: Spacing and edge distances**

Anchor size		All sizes	
Edge distance	$C_{cr}$ [mm]	100 (120) <sup>1)</sup>	
Minimum edge distance	$C_{min}$ <sup>2)</sup> [mm]	60	
Spacing	$S_{cr,II}$ [mm]	250	
	$S_{cr,L}$ [mm]	120	
Minimum spacing	$S_{min,II}$ [mm]	100	
	$S_{min,L}$ [mm]	120	

<sup>1)</sup> Value in brackets for VM-SH 20x85; VM-SH 20x130 and VM-SH 20x200

<sup>2)</sup> For  $V_{Rk,c}$ :  $C_{min}$  according to ETAG 029, Annex C

**Table C98: Group factor for anchor group in case of tension loading**

Configuration		with $c$ [mm] $\geq$	with $s$ [mm] $\geq$			
II: anchors placed parallel to horizontal joint		60	100	$\alpha_{g,N,II}$	[-]	1,0
		$C_{cr}$	250			2,0
I: anchors placed perpendicular to horizontal joint		60	100	$\alpha_{g,N,I}$		2,0

### Injection System VMU plus for masonry

**Annex C39**

#### Performance - Clay hollow brick Doppio Uni

Description of the brick, Spacing and edge distances, Group factor

**Brick type: Clay hollow brick Doppio Uni**

**Table C99: Group factor for anchor group in case of shear loading parallel to free edge**

Configuration		with $c$ [mm] $\geq$	with $s$ [mm] $\geq$			
II: anchors placed parallel to horizontal joint		$C_{cr}$	250	$\alpha_{g,V,II}$	[-]	2,0
I: anchors placed perpendicular to horizontal joint		$C_{cr}$	120	$\alpha_{g,V,I}$		2,0

**Table C100: Group factor for anchor group in case of shear load perpendicular to free edge**

Configuration		with $c$ [mm] $\geq$	with $s$ [mm] $\geq$			
II: anchors placed parallel to horizontal joint		$C_{cr}$	250	$\alpha_{g,V,II}$	[-]	2,0
I: anchors placed perpendicular to horizontal joint		$C_{cr}$	120	$\alpha_{g,V,I}$		2,0

**Table C101: Characteristic values of resistance under tension and shear load**

Anchor size	Sleeve	Effective Anchorage depth	Characteristic resistance			
			Use category			
			d/d w/d w/w			d/d w/d w/w
			40°C/24°C	80°C/50°C	120°C/72°C	All temperature ranges
		$h_{ef}$	$N_{RK,b} = N_{RK,p}^{1)}$			$V_{RK,b}^{2)3)}$
		[mm]	[kN]			[kN]
<b>Compressive strength <math>f_b \geq 10 \text{ N/mm}^2</math></b>						
M8	12x80	80	0,6	0,6	0,5	1,5
M8 / M10/ IG-M6	16x85	85				
	16x130	130				
M12 / M16 / IG-M8 / IG-M10	20x85	85				
	20x130	130				
	20x200	200				

1) Values are valid for  $c_{cr}$  and  $c_{min}$

2) Calculation of  $V_{RK,c}$  see ETAG 029, Annex C

3) The values are valid for steel 5.6 or higher. For steel 4.6 and 4.8 multiply  $V_{RK,b}$  by 0,8

**Injection System VMU plus for masonry**

**Annex C40**

**Performance - Clay hollow brick Doppio Uni**  
Group factor, Characteristic values of resistance



**Brick type: Clay hollow brick Doppio Uni**

**Table C102: Characteristic values of resistance under tension and shear load (continue)**

Anchor size	Sleeve	Effective Anchorage depth	Characteristic resistance			
			Use category			
			d/d w/d w/w			d/d w/d w/w
			40°C/24°C	80°C/50°C	120°C/72°C	All temperature ranges
$h_{ef}$	$N_{Rk,b} = N_{Rk,p}^{1)}$			$V_{Rk,b}^{2)3)}$		
[mm]	[kN]			[kN]		
<b>Compressive strength <math>f_b \geq 16 \text{ N/mm}^2</math></b>						
M8	12x80	80	0,75	0,75	0,6	2,0
M8 / M10/ IG-M6	16x85	85				
	16x130	130				
M12 / M16 / IG-M8 / IG-M10	20x85	85				
	20x130	130				
	20x200	200				
<b>Compressive strength <math>f_b \geq 20 \text{ N/mm}^2</math></b>						
M8	12x80	80	0,9	0,9	0,75	2,0
M8 / M10/ IG-M6	16x85	85				
	16x130	130				
M12 / M16 / IG-M8 / IG-M10	20x85	85				
	20x130	130				
	20x200	200				
<b>Compressive strength <math>f_b \geq 28 \text{ N/mm}^2</math></b>						
M8	12x80	80	1,2	1,2	0,9	2,5
M8 / M10/ IG-M6	16x85	85				
	16x130	130				
M12 / M16 / IG-M8 / IG-M10	20x85	85				
	20x130	130				
	20x200	200				

1) Values are valid for  $c_{cr}$  and  $c_{min}$

2) Calculation of  $V_{Rk,c}$  see ETAG 029, Annex C

3) The values are valid for steel 5.6 or higher. For steel 4.6 and 4.8 multiply  $V_{Rk,b}$  by 0,8

**Table C103: Displacements**

Anchor size	Sleeve	$h_{ef}$	N	$\delta_N / N$	$\delta_{N0}$	$\delta_{N\infty}$	V	$\delta_{v0}$	$\delta_{v\infty}$
		[mm]	[kN]	[mm/kN]	[mm]	[mm]	[kN]	[mm]	[mm]
All sizes	All sizes	All sizes	0,26	1,20	0,31	0,62	0,6	0,3	0,45

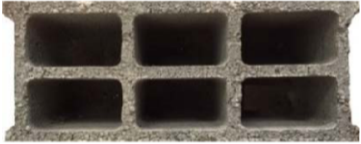
**Injection System VMU plus for masonry**

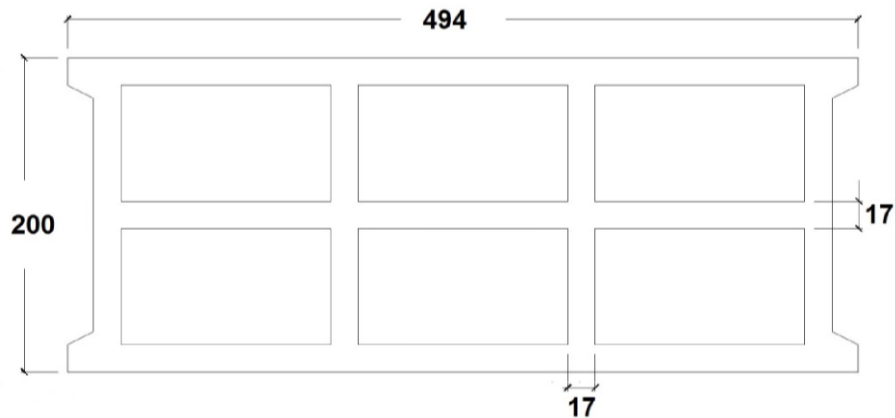
**Performance - Clay hollow brick Doppio Uni**  
Characteristic values of resistance, Displacements

**Annex C41**

## Brick type: Hollow lightweight concrete Bloc creux B40

**Table C104: Description of the brick**

<b>Brick type</b>	Hollow Lightweight concrete Bloc creux B40		
Bulk density	$\rho$ [kg/dm <sup>3</sup> ]	0,8	
Compressive strength	$f_b \geq$ [N/mm <sup>2</sup> ]	4	
Code	EN 771-3		
Producer (country code)	e.g. Sepa (FR)		
Brick dimensions	[mm]	494 x 200 x 190	
Drilling method	Rotary		



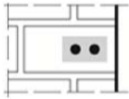
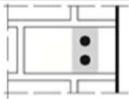
**Table C105: Spacing and edge distances**

Anchor size			All sizes
Edge distance	$C_{cr}$	[mm]	100 (120) <sup>1)</sup>
Minimum edge distance	$C_{min}$ <sup>2)</sup>	[mm]	100 (120) <sup>1)</sup>
Spacing	$S_{cr,II}$	[mm]	494
	$S_{cr,\perp}$	[mm]	190
Minimum spacing	$S_{min}$	[mm]	100

<sup>1)</sup> Value in brackets for VM-SH 20x85 and VM-SH 20x130

<sup>2)</sup> For  $V_{Rk,c}$ :  $C_{min}$  according to ETAG 029, Annex C

**Table C106: Group factor for anchor group in case of tension loading**

Configuration		with $c$ [mm] $\geq$	with $s$ [mm] $\geq$			
II: anchors placed parallel to horizontal joint		100	100	$\alpha_{g,N,II}$	[-]	1,5
		$C_{cr}$	494			2,0
⊥: anchors placed perpendicular to horizontal joint		100	100	$\alpha_{g,N,\perp}$		1,0
		$C_{cr}$	190			2,0

### Injection System VMU plus for masonry

#### Performance - Hollow Lightweight concrete Bloc creux B40

Description of the brick, Spacing and edge distances, Group factor

**Annex C42**

**Brick type: Hollow lightweight concrete Bloc creux B40**

**Table C107: Group factor for anchor group in case of shear loading parallel to free edge**

Configuration		with c [mm] ≥	with s [mm] ≥			
II: anchors placed parallel to horizontal joint		50	100	$\alpha_{g,V,II}$	[-]	1,1
		$c_{cr}$	494			2,0
I: anchors placed perpendicular to horizontal joint		100	100	$\alpha_{g,V,I}$	[-]	1,1
		$c_{cr}$	190			2,0

**Table C108: Group factor for anchor group in case of shear load perpendicular to free edge**

Configuration		with c [mm] ≥	with s [mm] ≥			
II: anchors placed parallel to horizontal joint		$c_{cr}$	494	$\alpha_{g,V,II}$	[-]	2,0
		$c_{cr}$	190			$\alpha_{g,V,I}$

**Table C109: Characteristic values of resistance under tension and shear load**

Anchor size	Sleeve	Effective anchorage depth	Characteristic resistance						
			Use category						
			d/d			w/d			d/d
			40°C/24°C	80°C/50°C	120°C/72°C	40°C/24°C	80°C/50°C	120°C/72°C	w/d
		$h_{ef}$	$N_{Rk,b} = N_{Rk,p}^{1)}$			$N_{Rk,b} = N_{Rk,p}^{1)}$			All temperature ranges
		[mm]	[kN]						$V_{Rk,b}^{2)3)}$
Compressive strength $f_b \geq 4 \text{ N/mm}^2$									
M8	12x80	80	1,2	0,9	0,75	0,9	0,9	0,75	3,0
M8 / M10/ IG-M6	16x85	85				1,2			
	16x130	130				1,2			
M12 / M16 / IG-M8 / IG-M10	20x85	85				1,2			
	20x130	130	1,2						

- 1) Values are valid for  $c_{cr}$  and  $c_{min}$
- 2) Calculation of  $V_{Rk,c}$  see ETAG 029, Annex C, except for shear load parallel to free edge with  $c \geq 250 \text{ mm}$ :  $V_{Rk,c,II} = V_{Rk,b}$
- 3) The values are valid for steel 5.6 or higher. For steel 4.6 and 4.8 multiply  $V_{Rk,b}$  by 0,8

**Table C110: Displacements**

Anchor size	Sleeve	$h_{ef}$	N	$\delta_N / N$	$\delta_{N0}$	$\delta_{N\infty}$	V	$\delta_{V0}$	$\delta_{V\infty}$
		[mm]	[kN]	[mm/kN]	[mm]	[mm]	[kN]	[mm]	[mm]
All sizes	All sizes	All sizes	0,34	0,90	0,31	0,62	0,86	0,9	1,35

**Injection System VMU plus for masonry**


**Annex C43**

**Performance - Hollow lightweight concrete Bloc creux B40**

Group factor, Characteristic values of resistance, Displacements

**Brick type: Solid lightweight concrete - LAC**

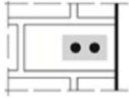
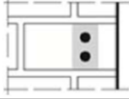
**Table C111: Description of the brick**

<b>Brick type</b>	Solid lightweight concrete LAC		
Bulk density $\rho$ [kg/dm <sup>3</sup> ]	0,6		
Compressive strength $f_b \geq$ [N/mm <sup>2</sup> ]	2		
Code	EN 771-3		
Producer (country code)	e.g. Bisotherm (DE)		
Brick dimensions [mm]	300 x 123 x 248		
Drilling method	Rotary		

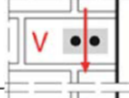
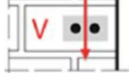
**Table C112: Spacing and edge distances**

Anchor size			All sizes
Edge distance	$C_{cr}$	[mm]	$1,5 \cdot h_{ef}$
Minimum edge distance	$C_{min}$	[mm]	60
Spacing	$S_{cr}$	[mm]	$3 \cdot h_{ef}$
Minimum spacing	$S_{min}$	[mm]	120

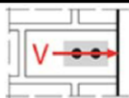

**Table C113: Group factor for anchor group in case of tension loading**

Configuration		with $c$ [mm] $\geq$	with $s$ [mm] $\geq$			
II: anchors placed parallel to horizontal joint		90	120	$\alpha_{g,N,II}$	[-]	1,1
		$1,5 \cdot h_{ef}$	$3 \cdot h_{ef}$			2,0
⊥: anchors placed perpendicular to horizontal joint		124	120	$\alpha_{g,N,\perp}$		1,1
		$1,5 \cdot h_{ef}$	$3 \cdot h_{ef}$			2,0

**Table C114: Group factor for anchor group in case of shear loading parallel to free edge**

Configuration		with $c$ [mm] $\geq$	with $s$ [mm] $\geq$			
II: anchors placed parallel to horizontal joint		60	120	$\alpha_{g,V,II}$	[-]	0,6
		90	120			2,0
⊥: anchors placed perpendicular to horizontal joint		60	120	$\alpha_{g,V,\perp}$		0,6
		124	120			2,0

**Table C115: Group factor for anchor group in case of shear load perpendicular to free edge**

Configuration		with $c$ [mm] $\geq$	with $s$ [mm] $\geq$			
II: anchors placed parallel to horizontal joint		60	120	$\alpha_{g,V,II}$	[-]	0,6
		90	120			2,0
⊥: anchors placed perpendicular to horizontal joint		60	120	$\alpha_{g,V,\perp}$		0,6
		$1,5 \cdot h_{ef}$	120			1,0
		$1,5 \cdot h_{ef}$	$3 \cdot h_{ef}$		2,0	

**Injection System VMU plus for masonry**

**Performance - Solid lightweight concrete - LAC**  
Description of the brick, Spacing and edge distances, Group factor

**Annex C44**

**Brick type: Solid lightweight concrete - LAC**

**Table C116: Characteristic values of resistance under tension and shear load**

Anchor size	Sleeve	Effective anchorage depth	Characteristic resistance						
			Use category						
			d/d			w/d w/w			d/d w/d w/w
			40°C/24°C	80°C/50°C	120°C/72°C	40°C/24°C	80°C/50°C	120°C/72°C	All temperature ranges
			$h_{ef}$	$N_{Rk,b} = N_{Rk,p}^{1)}$			$N_{Rk,b} = N_{Rk,p}^{1)}$		
[mm]	[kN]								
Compressive strength $f_b \geq 2 \text{ N/mm}^2$									
M8	-	80	3,0	2,5	2,0	2,5	2,0	1,5	3,0
M8 / M10/ IG-M6	-	90	3,0	3,0	2,0	2,5	2,5	2,0	3,0
M10 / IG-M8	-	100	3,5	3,0	2,5	3,0	2,5	2,0	3,0
M16 / IG-M10	-	100	3,0	3,0	2,0	3,0	3,0	2,0	3,0
M8	12x80	80	2,5	2,5	2,0	2,5	2,0	1,5	3,0
M8 / M10/ IG-M6	16x85	85	3,0	2,5	2,0	3,0	2,5	2,0	3,0
	16x130	130	3,0	2,5	2,0	3,0	2,5	2,0	3,0
M12 / M16 / IG-M8 / IG-M10	20x85	85	2,5	2,5	2,0	2,5	2,5	2,0	3,0
	20x130	130							
	20x200	200							

- 1) Values are valid for  $c_{cr}$ , values in brackets are valid for single anchors with  $c_{min}$   
 2) For calculation of  $V_{Rk,c}$  see ETAG029, Annex C  
 3) The values are valid for steel 5.6 or higher. For steel 4.6 and 4.8 multiply  $V_{Rk,b}$  by 0,8

**Table C117: Displacements**

Anchor size	Sleeve	$h_{ef}$	N	$\delta_N / N$	$\delta_{N0}$	$\delta_{N\infty}$	V	$\delta_{V0}$	$\delta_{V\infty}$
		[mm]	[kN]	[mm/kN]	[mm]	[mm]	[kN]	[mm]	[mm]
M8	-	80	0,86	0,50	0,43	0,86	0,9	0,25	0,38
M8 / M10/ IG-M6	-	90							
M10 / IG-M8	-	100							
M16 / IG-M10	-	100							
M8	12x80	80	0,71	0,35	0,25	0,50	0,9	0,25	0,38
M8 / M10/ IG-M6	16x85	85							
	16x130	130							
M12 / M16 / IG-M8 / IG-M10	20x85	85							
	20x130	130							
	20x200	200							

**Injection System VMU plus for masonry**

**Performance - Solid lightweight concrete - LAC**  
 Characteristic values of resistance, Displacements

**Annex C45**