



...eine starke Verbindung

## DECLARATION OF PERFORMANCE

DoP Nr.: **MKT-2.1-100\_en**

- ✧ **Unique identification code of product-type:** **MKT Injection System VMZ**
- ✧ **Intended use/es:** Torque controlled bonded anchor with anchor rod VMZ-A and internal threaded rod VMZ-IG for use in concrete, see Annex B
- ✧ **Manufacturer:** MKT Metall-Kunststoff-Technik GmbH & Co.KG  
Auf dem Immel 2  
67685 Weilerbach
- ✧ **System/s of AVCP:** 1
- ✧ **European Assessment Document:** **ETAG 001-5**  
European Technical Assessment: **ETA-11/0415, 08.12.2017**  
Technical Assessment Body: DIBt, Berlin  
Notified body/ies: NB 2873 – Technische Universität Darmstadt

✧ **Declared performance/s:**

Essential characteristics	Performance
<b>Mechanical resistance and stability (BWR 1)</b>	
Characteristic resistance of VMZ-A	Annex C1 – C7
Displacements under tension and shear loads for VMZ-A	Annex C8 – C9
Characteristic resistance of VMZ-IG	Annex C10 – C12
Displacements under tension and shear loads for VMZ-IG	Annex C12
<b>Safety in case of fire (BWR 2)</b>	
Reaction to fire	Class A1
Resistance to fire	No Performance Determined (NPD)

The performance of the product identified above is in conformity with the set of declared performance/s. This declaration of performance is issued, in accordance with Regulation (EU) No 305/2011, under the sole responsibility of the manufacturer identified above.

Signed for and on behalf of the manufacturer by:

  
**Stefan Weustenhagen**  
(General manager)

**Weilerbach, 01.01.2021**

p.p.   
**Dipl.-Ing. Detlef Bigalke**  
(Head of product development)



The original of this declaration of performance was written in German. In the event of deviations in the translation, the German version shall be valid.

## Specifications of intended use

Injection System VMZ-A		M8	M10	M12	M16	M20	M24
Static or quasi-static action		✓					
Seismic action (Category C1 + C2)		-	✓	✓	✓	✓	✓
Cracked and uncracked concrete		✓					
Strength classes acc. to EN 206-1:2000 C20/25 to C50/60		✓					
Reinforced or unreinforced normal weight concrete acc. to EN 206-1:2000		✓					
Temperature Range I	-40 °C to +80 °C	max. short term temperature +80 °C and max. long term temperature +50 °C					
Temperature Range II	-40 °C to +120 °C	max. short term temperature +120 °C and max. long term temperature +72 °C					
Making of drill hole	Hammer drill bit	✓					
	Vacuum drill bit <sup>1)</sup>	-	✓	✓	✓	✓	✓
	Diamond drill bit (seismic action excluded)	-	✓	✓	✓	✓	✓
Installation allowable in	dry concrete	✓					
	wet concrete	✓					
	water-filled hole	-	-	✓ <sup>2)</sup>	✓	✓	✓
Overhead installation admissible		✓	✓	✓	✓	✓	✓

<sup>1)</sup> e.g. MKT vacuum drill bit, Würth hammer drill bit with suction or Heller Duster Expert

<sup>2)</sup> exception: VMZ-A 75M12 (Installation in water-filled drill hole is not allowed)

Injection System VMZ-IG		M6	M8	M10	M12	M16	M20
Static or quasi-static action		✓					
Seismic action (Category C1 + C2)		-					
Cracked and uncracked concrete		✓					
Strength classes acc. to EN 206-1:2000 C20/25 to C50/60		✓					
Reinforced or unreinforced normal weight concrete acc. to EN 206-1:2000		✓					
Temperature Range I	-40 °C to +80 °C	max. short term temperature +80 °C and max. long term temperature +50 °C					
Temperature Range II	-40 °C to +120 °C	max. short term temperature +120 °C and max. long term temperature +72 °C					
Making of drill hole	Hammer drill bit	✓					
	Vacuum drill bit <sup>1)</sup>	-	✓	✓	✓	✓	✓
	Diamond drill bit (seismic action excluded)	-	✓	✓	✓	✓	✓
Installation allowable in	dry concrete	✓					
	wet concrete	✓					
	water-filled hole	-	-	✓	✓	✓	✓
Overhead installation admissible		✓	✓	✓	✓	✓	✓

<sup>1)</sup> e.g. MKT vacuum drill bit, Würth hammer drill bit with suction or Heller Duster Expert

## Injection System VMZ

**Intended use**  
Specifications, installation conditions

**Annex B1**

## Specifications of intended use

### Use conditions (Environmental conditions):

- Structures subject to dry internal conditions (zinc plated steel, stainless steel or high corrosion resistant steel).
- Structures subject to external atmospheric exposure including industrial and marine environment or exposure to permanently damp internal condition, if no particular aggressive conditions exist (stainless steel or high corrosion resistant steel).
- Structures subject to external atmospheric exposure and to permanently damp internal condition, if other particular aggressive conditions (high corrosion resistant steel).

Note: Particular aggressive conditions are e.g. permanent, alternating immersion in seawater or the splash zone of seawater, chloride atmosphere of indoor pools or atmosphere with extreme chemical pollution (e.g. in desulphurization plants or road tunnels where de-icing materials are used).

### Design:

- Anchorages are designed under the responsibility of an engineer experienced in anchorages and concrete work.
- Verifiable calculation notes and drawings are prepared taking account of the loads to be anchored. The position of the anchor is indicated on the design drawings (e.g. position of the anchor relative to reinforcement or to supports, etc.).
- Anchorages under static or quasi-static actions are designed in accordance with:
  - ETAG 001, Annex C, design method A, Edition August 2010 or
  - CEN/TS 1992-4:2009, design method A
- Anchorages under seismic actions (cracked concrete) are designed in accordance with:
  - EOTA Technical Report TR 045, Edition February 2013
  - Anchorages shall be positioned outside of critical regions (e.g. plastic hinges) of the concrete structure.
  - Fastenings in stand-off installation or with a grout layer are not allowed.

### Installation:

- Anchor installation carried out by appropriately qualified personnel and under the supervision of the person responsible for technical matters of the site.
- In case of aborted drill hole: the drill hole shall be filled with mortar.
- Drill hole must be cleaned directly prior to installation of the anchor or the drill hole has to be protected against re-contamination in an appropriate way until dispensing the mortar in the drill hole.
- Water filled drill holes (where admissible) must not be polluted – otherwise the cleaning of the drill hole must be repeated.
- The anchor component installation temperature shall be at least +5 °C; during curing of the injection mortar the temperature of the concrete must not fall below -5 °C. Curing time must be observed prior to loading the anchor.
- It must be ensured that icing does not occur in the drill hole.
- Optionally, the annular gap between anchor rod and fixture may be filled with injection adhesive VMZ using the washer with bore (Part 2b, Annex A3) instead of the washer (Part 2a, Annex A3).

## Injection System VMZ

Intended use  
Specifications

Annex B2

**Table B1: Processing and curing time VMZ**

Temperature in the drill hole	Maximum processing time	Minimum curing time	
		dry concrete	wet concrete
+ 40 °C	1,4 min	15 min	30 min
+ 35 °C to + 39 °C	1,4 min	20 min	40 min
+ 30 °C to + 34 °C	2 min	25 min	50 min
+ 20 °C to + 29 °C	4 min	45 min	1:30 h
+ 10 °C to + 19 °C	6 min	1:20 h	2:40 h
+ 5 °C to + 9 °C	12 min	2:00 h	4:00 h
0 °C to + 4 °C	20 min	3:00 h	6:00 h
- 4 °C to - 1 °C	45 min	6:00 h	12:00 h
- 5 °C	1:30 h	6:00 h	12:00 h

**Table B2: Processing and curing time VMZ express**

Temperature in the drill hole	Maximum processing time	Minimum curing time	
		dry concrete	wet concrete
+ 30 °C	1 min	10 min	20 min
+ 20 °C to + 29 °C	1 min	20 min	40 min
+ 10 °C to + 19 °C	3 min	40 min	80 min
+ 5 °C to + 9 °C	6 min	1:00 h	2:00 h
+ 0 °C to + 4 °C	10 min	2:00 h	4:00 h
- 4 °C to - 1 °C	20 min	4:00 h	8:00 h
- 5 °C	40 min	4:00 h	8:00 h

**Injection System VMZ**

**Intended use**  
Processing and curing time

**Annex B3**

**Table B3: Installation parameters, VMZ-A M8 – M12**

Anchor size VMZ-A			40 M8	50 M8	60 M10	75 M10	75 M12	70 M12	80 M12	95 M12	100 M12	110 M12	125 M12
Effective anchorage depth	$h_{ef} \geq$	[mm]	40	50	60	75	75	70	80	95	100	110	125
Nominal diameter of drill hole	$d_0 =$	[mm]	10	10	12	12	12	14	14	14	14	14	14
Depth of drill hole	$h_0 \geq$	[mm]	42	55	65	80	80	75	85	100	105	115	130
Diameter of cleaning brush	$D \geq$	[mm]	10,8	10,8	13,0	13,0	13,0	15,0	15,0	15,0	15,0	15,0	15,0
Installation torque	$T_{inst} \leq$	[Nm]	10	10	15	15	25	25	25	25	30	30	30
Diameter of clearance hole in the fixture													
Pre-setting installation	$d_f \leq$	[mm]	9	9	12	12	14	14	14	14	14	14	14
Through-setting installation	$d_f \leq$	[mm]	-	-	14	14	14 <sup>1)</sup> / 16	16	16	16	16	16	16

<sup>1)</sup> see Annex B11

**Table B4: Installation parameters, VMZ-A M16 – M24**

Anchor size VMZ-A			90 M16	105 M16	125 M16	145 M16	160 M16	115 M20	170 M20 (LG)	190 M20 (LG)	170 M24 (LG)	200 M24 (LG)	225 M24 (LG)
Effective anchorage depth	$h_{ef} \geq$	[mm]	90	105	125	145	160	115	170	190	170	200	225
Nominal diameter of drill hole	$d_0 =$	[mm]	18	18	18	18	18	22	24	24	26	26	26
Depth of drill hole	$h_0 \geq$	[mm]	98	113	133	153	168	120	180	200	185	215	240
Diameter of cleaning brush	$D \geq$	[mm]	19,0	19,0	19,0	19,0	19,0	23,0	25,0	25,0	27,0	27,0	27,0
Installation torque	$T_{inst} \leq$	[Nm]	50	50	50	50	50	80	80	80	100	120	120
Diameter of clearance hole in the fixture													
Pre-setting installation	$d_f \leq$	[mm]	18	18	18	18	18	22	24 (22)	24 (22)	26	26	26
Through-setting installation	$d_f \leq$	[mm]	20	20	20	20	20	24	26	26	28	28	28

**Pre-setting installation**

**Through-setting installation**

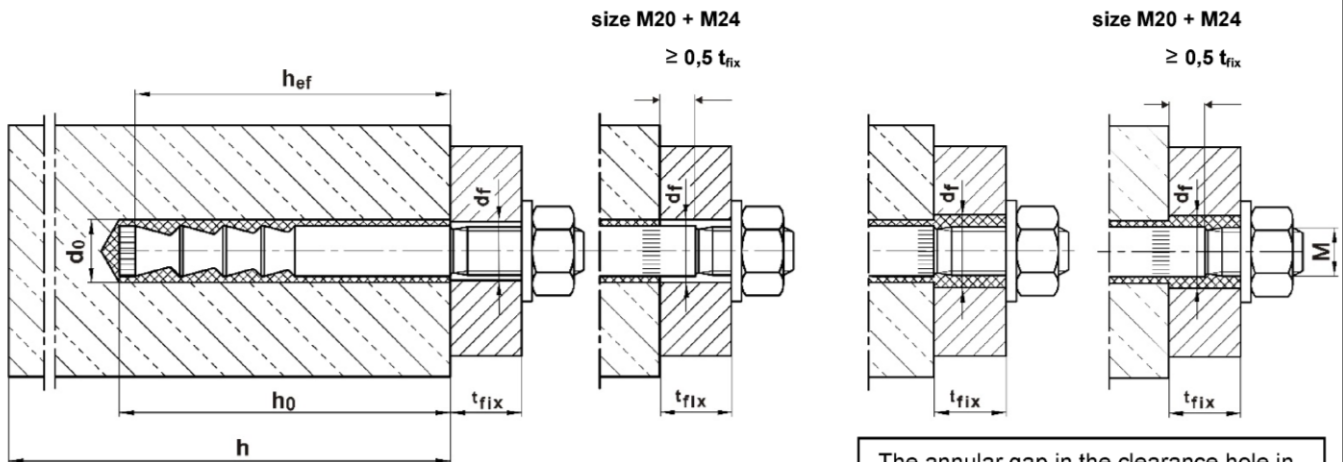

The annular gap in the clearance hole in the fixture has to be filled completely by excess mortar!

**Injection System VMZ**

**Intended use**  
Installation parameters VMZ-A

**Annex B4**

**Table B5: Minimum spacing and edge distance, VMZ-A M8 – M12**

Anchor size VMZ-A			40 M8	50 M8	60 M10	75 M10	75 M12	70 M12	80 M12	95 M12	100 M12	110 M12	125 M12
Minimum thickness of concrete	$h_{min}$	[mm]	80	80	100	110 100 <sup>1)</sup>	110	110	110	130 125 <sup>1)</sup>	130	140	160
<b>Cracked concrete</b>													
Minimum spacing	$s_{min}$	[mm]	40	40	40	40	50	55	40	40	50	50	50
Minimum edge distance	$c_{min}$	[mm]	40	40	40	40	50	55	50	50	50	50	50
<b>Uncracked concrete</b>													
Minimum spacing	$s_{min}$	[mm]	40	40	50	50	50	55	55	55	80 <sup>2)</sup>	80 <sup>2)</sup>	80 <sup>2)</sup>
Minimum edge distance	$c_{min}$	[mm]	40	40	50	50	50	55	55	55	55 <sup>2)</sup>	55 <sup>2)</sup>	55 <sup>2)</sup>

**Table B6: Minimum spacing and edge distance, VMZ-A M16 – M24**

Anchor size VMZ-A			90 M16	105 M16	125 M16	145 M16	160 M16	115 M20	170 M20 (LG)	190 M20 (LG)	170 M24 (LG)	200 M24 (LG)	225 M24 (LG)
Minimum thickness of concrete	$h_{min}$	[mm]	130	150	170 160 <sup>1)</sup>	190 180 <sup>1)</sup>	205 200 <sup>1)</sup>	160	230 220 <sup>1)</sup>	250 240 <sup>1)</sup>	230 220 <sup>1)</sup>	270 260 <sup>1)</sup>	300 290 <sup>1)</sup>
<b>Cracked concrete</b>													
Minimum spacing	$s_{min}$	[mm]	50	50	60	60	60	80	80	80	80	80	80
Minimum edge distance	$c_{min}$	[mm]	50	50	60	60	60	80	80	80	80	80	80
<b>Uncracked concrete</b>													
Minimum spacing	$s_{min}$	[mm]	50	60	60	60	60	80	80	80	80	105	105
Minimum edge distance	$c_{min}$	[mm]	50	60	60	60	60	80	80	80	80	105	105

<sup>1)</sup> The remote face of the concrete member shall be inspected to ensure there has been no break-through by drilling. In case of break-through, the ground of the drill hole shall be closed with high strength mortar. The full bonded length  $h_{ef}$  shall be achieved and any potential loss of injection mortar shall be compensated.

<sup>2)</sup> For an edge distance  $c \geq 80$  mm a minimum spacing  $s_{min} = 55$  mm is applicable.

<b>Injection System VMZ</b>	<b>Annex B5</b>
<b>Intended use</b> Minimum spacing and edge distance, <b>VMZ-A</b>	

# Installation instructions VMZ-A

## Hole drilling and cleaning (hammer drill bit)

1	Pre-setting installation V		Use Hammer drill or air drill with drill bit and depth gauge. Drill perpendicular to concrete surface.
	Through-setting installation D		
2	V		<b>VMZ-A M8 - M16:</b> Blow out drill hole from the bottom with Blow-out pump VM-AP at least two times. The Extension Tube with reduced diameter must be added to the Blow-out pump for the diameter M8.
			<b>VMZ-A M20 - M24:</b> Connect Air Blower VM-ABP to compressed air (min. 6 bar, oil-free). Open air valve and blow out drill hole along the entire depth with back and forth motion at least two times.
	D		<b>VMZ-A M10 - M16:</b> Blow out drill hole from the bottom with Blow-out pump VM-AP at least two times.
			<b>VMZ-A M20 - M24:</b> Connect Air Blower VM-ABP to compressed air (min. 6 bar, oil-free). Open air valve and blow out drill hole along the entire depth with back and forth motion at least two times.
3	V		Check diameter of cleaning brush RB. If the brush can be pushed into the drill hole without any resistance, it must be replaced. Chuck brush into drill machine. Turn on drill machine. Brush drill hole back and forth along the entire drill hole depth at least two times while rotated by drill machine.
	D		
4	V		<b>VMZ-A M8 - M16:</b> Blow out drill hole from the bottom with Blow-out pump VM-AP at least two times. The Extension Tube with reduced diameter must be added to the Blow-out pump for the diameter M8.
			<b>VMZ-A M20 - M24:</b> Connect Air Blower VM-ABP to compressed air (min. 6 bar, oil-free). Open air valve and blow out drill hole along the entire depth with back and forth motion at least two times.
	D		<b>VMZ-A M10 - M16:</b> Blow out drill hole from the bottom with Blow-out pump VM-AP at least two times.
			<b>VMZ-A M20 - M24:</b> Connect Air Blower VM-ABP to compressed air (min. 6 bar, oil-free). Open air valve and blow out drill hole along the entire depth with back and forth motion at least two times.

### Injection System VMZ

#### Intended use

Installation instructions **VMZ-A**  
Hole drilling and cleaning (hammer drill bit)

**Annex B6**

**Hole drilling and cleaning (vacuum drill bit)**

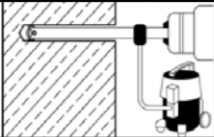
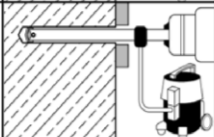
1	Pre-setting installation V		Drill hole perpendicular to concrete surface by using a vacuum drill bit (see Annex B1).
	Through-setting installation D		The nominal underpressure of the vacuum cleaner must be at least 230 mbar / 23kPa. <b>Make sure the dust extraction is working properly</b> throughout the whole drilling process.
Additional cleaning is not necessary - continue with step 5!			

**Injection System VMZ**

**Intended use**  
 Installation instructions **VMZ-A**  
 Hole drilling and cleaning (vacuum drill bit)

**Annex B7**



### Hole drilling and cleaning (diamond drill bit)

1	Pre-setting installation V		Use diamond drill with diamond drill bit and depth gauge. Drill perpendicular to concrete surface.
	Through-setting installation D		
2	V		Remove drill core at least up to the nominal hole depth and check drill hole depth.
	D		
3	V		Flushing of drill hole: Flush drill hole with water, starting from the bottom, until clear water gets out of the drill hole.
	D		
4	V		Connect Air Blower VM-ABP to compressed air (min. 6 bar, oil-free). Open air valve and blow out drill hole along the entire depth with back and forth motion at least two times.
	D		

### Injection System VMZ

**Intended use**  
Installation instructions **VMZ-A**  
Hole drilling and cleaning (diamond drill bit)

**Annex B8**

## Injection

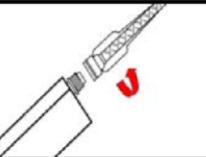
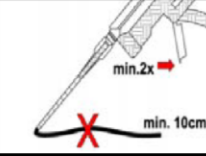
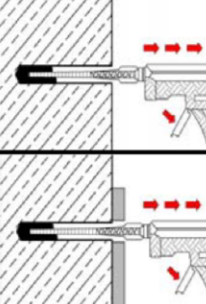
5	D+V		<p>Check expiration date on VMZ cartridge. Never use when expired. Remove cap from VMZ cartridge. Screw Mixer Nozzle VM-X on cartridge. When using a new cartridge always use a new Mixer Nozzle. Never use cartridge without Mixer Nozzle and never use Mixer Nozzle without helix inside.</p>
6	D+V		<p>Insert cartridge in Dispenser. Before injecting discard mortar (at least 2 full strokes or a line of 10 cm) until it shows a consistent grey colour. Never use this mortar.</p>
7	V D		<p>Prior to injection, check if Mixer Nozzle VM-X reaches the bottom of the drill hole. If it does not reach the bottom, plug Mixer Extension VM-XE onto Mixer Nozzle in order to fill the drill hole properly. Fill hole with a sufficient quantity of injection mortar. Start from the bottom of the drill hole and work out to avoid trapping air pockets.</p>

### Injection System VMZ

**Intended use**  
 Installation instructions **VMZ-A**  
 Injection

**Annex B9**

## Insertion of anchor rod

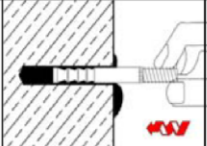
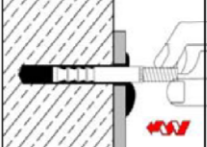
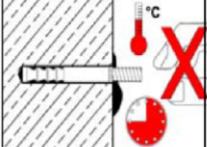
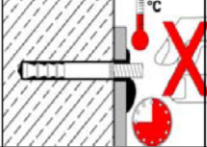
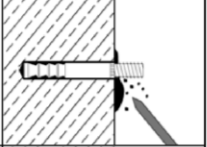
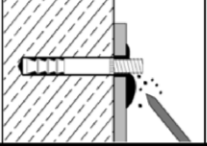
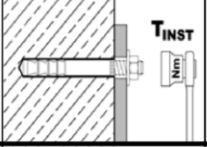
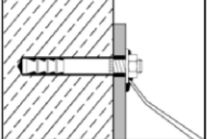
8	V		Insert the anchor rod VMZ-A by hand, rotating slightly up to the full embedment depth as marked on the anchor rod. The anchor rod is properly set when excess mortar seeps from the hole. If the hole is not completely filled, pull out anchor rod, let mortar cure, drill out hole and repeat entire cleaning process.
	D		Insert the anchor rod VMZ-A by hand, rotating slightly up to the full embedment depth. After the installation, the annular gap in the clearance hole in the fixture has to be filled completely by excess mortar. If the hole is not completely filled, pull out anchor rod, let mortar cure, drill out hole and repeat entire cleaning process.
9	V		Follow minimum curing time shown in Table B1 or Table B2. During curing time, anchor rod must not be moved or loaded.
	D		
10	V		Remove excess mortar.
	D		
11	D + V		The fixture can be mounted after curing time. Apply installation torque $T_{inst}$ according to Table B3 or Table B4 by using torque wrench.
Optional	V		Annular gap between anchor rod and attachment may optionally be filled with mortar. Therefore replace regular washer by washer with bore and plug on reducing adapter on static mixer. Annular gap is completely filled, when excess mortar seeps out.

## Injection System VMZ

**Intended use**  
Installation instructions VMZ-A  
Anchor installation

**Annex B10**

## Installation instructions VMZ-A 75 M12

### Through-setting installation with clearance between concrete and anchor plate

Work step 1-7 as illustrated in Annexes B6 – B9

**Requirement: Diameter of clearance hole in the fixture  $d_f \leq 14$  mm**

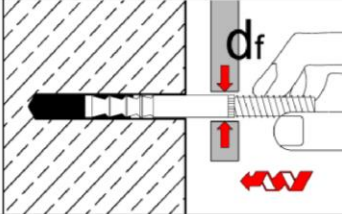
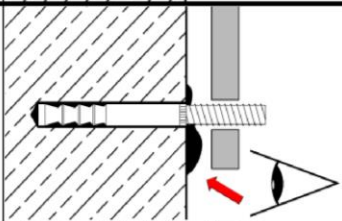
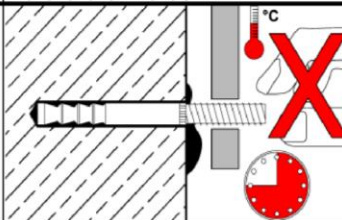
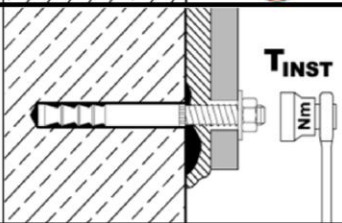
8		<p>Insert the anchor rod VMZ-A by hand, rotating slightly up to the full embedment depth.</p>
9		<p>Check if excess mortar seeps from the hole. If the hole is not completely filled, pull out anchor rod, let mortar cure, drill out hole and repeat the entire cleaning process.</p> <p><b>The annular gap in the fixture does not have to be filled.</b></p>
10		<p>During curing time according to Table B1 or Table B2 anchor rod must not be moved or loaded.</p>
11		<p>Washer and nut can be mounted after curing time and backfilling of anchor plate. Apply installation torque <math>T_{inst}</math> according to Table B3 by using torque wrench.</p>

**Injection System VMZ**

**Intended use**

Installation instructions **VMZ-A 75 M12**

Through-setting installation with clearance between concrete and anchor plate

**Annex B11**

**Table B7: Installation parameters VMZ-IG**

Anchor size VMZ-IG			40 M6	50 M6	60 M8	75 M8	70 M10	80 M10	90 M12	105 M12	125 M12	115 M16	170 M16	170 M20
Effective anchorage depth	$h_{ef} =$	[mm]	40	50	60	75	70	80	90	105	125	115	170	170
Nominal diameter of drill hole	$d_0 =$	[mm]	10	10	12	12	14	14	18	18	18	22	24	26
Depth of drill hole	$h_0 \geq$	[mm]	42	55	65	80	80	85	98	113	133	120	180	185
Diameter of cleaning brush	$D \geq$	[mm]	10,8	10,8	13,0	13,0	15,0	15,0	19,0	19,0	19,0	23,0	25,0	27,0
Installation torque	$T_{inst} \leq$	[Nm]	8	8	10	10	15	15	25	25	25	50	50	80
Diameter of clearance hole in the fixture	$d_f \leq$	[mm]	7	7	9	9	12	12	14	14	14	18	18	22
Available thread length	$L_{th}$	[mm]	12	15	16	19	20	23	24	27	30	32	32	40
Minimum screw-in depth	$L_{sdmin}$	[mm]	7	7	9	9	12	12	14	14	14	18	18	22
Minimum thickness of concrete	$h_{min}$	[mm]	80	80	100	110	110	110	130	150	170 <sup>1)</sup> 160 <sup>1)</sup>	160	230 <sup>1)</sup> 220 <sup>1)</sup>	230 <sup>1)</sup> 220 <sup>1)</sup>
<b>Cracked concrete</b>														
Minimum spacing	$s_{min}$	[mm]	40	40	40	40	55	40	50	50	60	80	80	80
Minimum edge distance	$c_{min}$	[mm]	40	40	40	40	55	50	50	50	60	80	80	80
<b>Uncracked concrete</b>														
Minimum spacing	$s_{min}$	[mm]	40	40	50	50	55	55	50	60	60	80	80	80
Minimum edge distance	$c_{min}$	[mm]	40	40	50	50	55	55	50	60	60	80	80	80

<sup>1)</sup> The remote face of the concrete member shall be inspected to ensure there has been no break-through by drilling. In case of break-through the ground of the drill hole shall be closed with high strength mortar. The full bonded length  $h_{ef}$  shall be achieved and any potential loss of injection mortar shall be compensated.

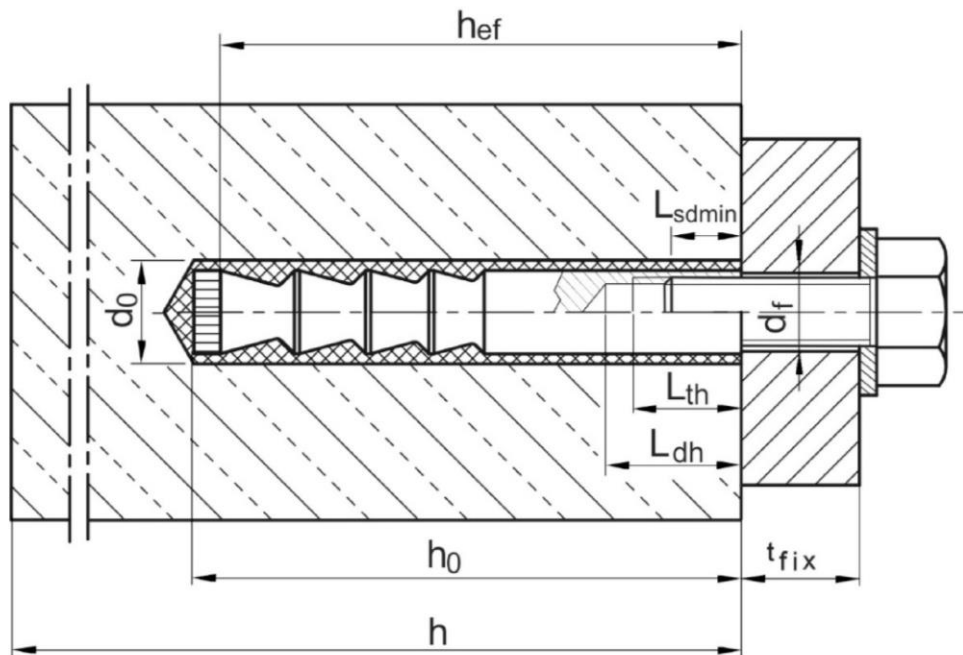

**Injection System VMZ**

**Intended use**  
Installation parameters VMZ-IG

**Annex B12**

## Installation instructions VMZ-IG

### Hole drilling and cleaning (hammer drill bit)

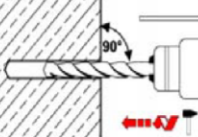
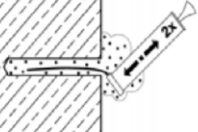
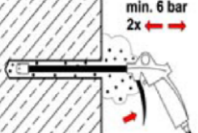
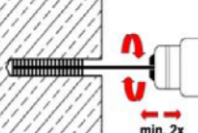
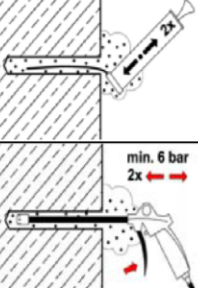
1		<p>Use Hammer drill or air drill with drill bit and depth gauge. Drill perpendicular to concrete surface.</p>
2		<p><b>VMZ-IG M6 - M12:</b> Blow out drill hole from the bottom with Blow-out pump VM-AP at least two times. The Extension Tube with reduced diameter must be added to the Blow-out pump for the diameter M6.</p>
3		<p><b>VMZ-IG M16 - M20:</b> Connect MKT Air Blower VM-ABP to compressed air (min. 6 bar, oil-free). Open air valve and blow out drill hole along the entire depth with back and forth motion at least two times.</p>
4		<p><b>VMZ-IG M6 - M12:</b> Blow out drill hole from the bottom with Blow-out pump VM-AP at least two times. The Extension Tube with reduced diameter must be added to the Blow-out pump for the diameter M6.</p>
4		<p><b>VMZ-IG M16 - M20:</b> Connect Air Blower VM-ABP to compressed air (min. 6 bar, oil-free). Open air valve and blow out drill hole along the entire depth with back and forth motion at least two times.</p>

### Hole drilling and cleaning (vacuum drill bit)

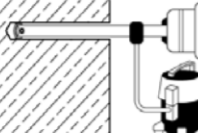
1		<p>Drill hole perpendicular to concrete surface by using a vacuum drill bit (see Annex B1). The nominal underpressure of the vacuum cleaner must be at least 230 mbar / 23kPa. <b>Make sure the dust extraction is working properly</b> throughout the whole drilling process.</p>
<p>Additional cleaning is not necessary, go to step 5.</p>		

## Injection System VMZ

### Intended use

Installation instructions **VMZ-IG**  
Drilling and cleaning (hammer drill bit or a vacuum drill bit)

**Annex B13**

### Hole drilling and cleaning (diamond drill bit)

1		Use diamond drill with diamond drill bit and depth gauge. Drill perpendicular to concrete surface.
2		Remove drill core at least up to the nominal hole depth and check drill hole depth.
3		Flushing of drill hole: Flush drill hole with water, starting from the bottom, until clear water gets out of the drill hole.
4		Connect Air Blower VM-ABP to compressed air (min. 6 bar, oil-free). Open air valve and blow out drill hole along the entire depth with back and forth motion at least two times.

### Injection

5		Check expiration date on VMZ cartridge. Never use when expired. Remove cap from VMZ cartridge. Screw Mixer Nozzle VM-X on cartridge. When using a new cartridge always use a new Mixer Nozzle. Never use cartridge without Mixer Nozzle and never use Mixer Nozzle without helix inside.
6		Insert cartridge in dispenser. Before injecting discard mortar (at least 2 full strokes or a line of 10 cm) until it shows a consistent grey colour. Never use this mortar.
7		Prior to injection, check if Mixer Nozzle VM-X reaches the bottom of the drill hole. If it does not reach the bottom, plug Mixer Extension VM-XE onto Mixer Nozzle in order to fill the drill hole properly. Fill cleaned drill hole with a sufficient quantity of injection mortar. Start from the bottom of the drill hole and work out to avoid trapping air pockets.

### Setting of anchor

8		Insert the anchor rod VMZ-IG by hand, rotating slightly up to about 1mm below the concrete surface in the drill hole. The anchor rod is properly set when excess mortar seeps from the hole. If the hole is not completely filled, pull out anchor rod, let mortar cure, drill out hole and repeat the entire cleaning process.
9		Follow minimum curing time shown in Table B1 and Table B2. During curing time anchor rod must not be moved or loaded.
10		Remove excess mortar.
11		The fixture can be mounted after curing time. Apply installation torque $T_{inst}$ according to Table B7 by using torque wrench.

### Injection System VMZ

**Intended use**  
 Installation instructions **VMZ-IG**  
 Drilling and cleaning (diamond drill bit)  
 Anchor installation

**Annex B14**

**Table C1: Characteristic values for tension loads, VMZ-A M8 – M12, cracked concrete, static and quasi-static action**

Anchor size VMZ-A			40 M8	50 M8	60 M10	75 M10	75 M12	70 M12	80 M12	95 M12	100 M12	110 M12	125 M12
Installation safety factor	$\gamma_2 = \gamma_{inst}$	[-]	1,0										
<b>Steel failure</b>													
Characteristic tension resistance $N_{Rk,s}$	Steel, zinc plated	[kN]	15	18	25	35	49	54	57				
	A4, HCR	[kN]	15	18	25	35	49	54	57				
Partial safety factor	$\gamma_{Ms}$	[-]	1,5										
<b>Pull-out</b>													
Characteristic resistance $N_{Rk,p}$ in concrete C20/25	50°C / 80°C <sup>2)</sup>	[kN]	1)										
	72°C / 120°C <sup>2)</sup>	[kN]	5	7,5	12	12	12	16	20	20	30	30	30
Increasing factor	$\psi_C$	[-]	$\left(\frac{f_{ck,cube}}{25}\right)^{0,5}$										
<b>Concrete cone failure</b>													
Effective anchorage depth	$h_{ef} \geq$	[mm]	40	50	60	75	75	70	80	95	100	110	125
Factor acc. to CEN/TS 1992-4	$k_{cr}$	[-]	7,2										

<sup>1)</sup> Pull-out failure is not decisive

<sup>2)</sup> Maximum long term temperature / Maximum short term temperature

**Table C2: Characteristic values for tension loads, VMZ-A M16 – M24, cracked concrete, static and quasi-static action**

Anchor size VMZ-A			90 M16	105 M16	125 M16	145 M16	160 M16	115 M20	170 M20 (LG)	190 M20 (LG)	170 M24 (LG)	200 M24 (LG)	225 M24 (LG)	
Installation safety factor	$\gamma_2 = \gamma_{inst}$	[-]	1,0											
<b>Steel failure</b>														
Characteristic tension resistance $N_{Rk,s}$	Steel, zinc plated	[kN]	88	95	111	97	96	188		222				
	A4, HCR	[kN]	88	95	111	97	114	165		194				
Partial safety factor	$\gamma_{Ms}$	[-]	1,5				1,68		1,5		1,5			
<b>Pull-out</b>														
Characteristic resistance $N_{Rk,p}$ in concrete C20/25	50°C / 80°C <sup>2)</sup>	[kN]	1)											
	72°C / 120°C <sup>2)</sup>	[kN]	25	30	50	51	30	60		75				
Increasing factor	$\psi_C$	[-]	$\left(\frac{f_{ck,cube}}{25}\right)^{0,5}$											
<b>Concrete cone failure</b>														
Effective anchorage depth	$h_{ef} \geq$	[mm]	90	105	125	145	160	115	170	190	170	200	225	
Factor acc. to CEN/TS 1992-4	$k_{cr}$	[-]	7,2											

<sup>1)</sup> Pull-out failure is not decisive

<sup>2)</sup> Maximum long term temperature / Maximum short term temperature

<b>Injection System VMZ</b>	<b>Annex C1</b>
<b>Performance</b> Characteristic values for <b>tension loads, VMZ-A</b> in cracked concrete, static and quasi-static action	



**Table C3: Characteristic values for tension loads, VMZ-A M8 – M12 in uncracked concrete, static and quasi-static action**

Anchor size VMZ-A			40 M8	50 M8	60 M10	75 M10	75 M12	70 M12	80 M12	95 M12	100 M12	110 M12	125 M12	
Installation safety factor	$\gamma_2 = \gamma_{inst}$	[-]	1,0											
<b>Steel failure</b>														
Characteristic tension resistance $N_{Rk,s}$	Steel, zinc plated	[kN]	15	18	25	35	49	54	57					
	A4, HCR	[kN]	15	18	25	35	49	54	57					
Partial safety factor	$\gamma_{Ms}$	[-]	1,5											
<b>Pull-out</b>														
Characteristic resistance $N_{Rk,p}$ in uncracked concrete C20/25	50°C / 80°C <sup>2)</sup>	[kN]	9	1) <sup>1)</sup>	1) <sup>1)</sup>	1) <sup>1)</sup>			40	1) <sup>1)</sup>	50	50		
	72°C / 120°C <sup>2)</sup>	[kN]	6	9	16	16	16	25	25	30	30	30		
<b>Splitting</b>														
Splitting for <b>standard thickness of concrete member</b> (The higher resistance of Case 1 and Case 2 may be applied.)														
Standard thickness of concrete	$h_{std} \geq 2 h_{ef}$	[mm]	100	120	150	150	140	160	190	200	220	250		
<b>Case 1</b> ( $N_{Rk,c}^0$ has to be replaced by $N_{Rk,sp}^0$ )														
Characteristic resistance in uncracked concrete C20/25	$N_{Rk,sp}^0$	[kN]	7,5	9	16	20	20	20	1) <sup>1)</sup>	30	40	40	40	
Spacing (edge distance)	$s_{cr,sp} (= 2 C_{cr,sp})$	[mm]	3 $h_{ef}$											
<b>Case 2</b>														
Spacing (edge distance)	$s_{cr,sp} (= 2 C_{cr,sp})$	[mm]	6 $h_{ef}$	5 $h_{ef}$	7 $h_{ef}$	7 $h_{ef}$	5 $h_{ef}$	3 $h_{ef}$	5 $h_{ef}$	4 $h_{ef}$	6 $h_{ef}$	5 $h_{ef}$		
Splitting for <b>minimum thickness of concrete member</b> (The higher resistance of Case 1 and Case 2 may be applied.)														
Minimum thickness of concrete	$h_{min} \geq$	[mm]	80	100	110	110	110	125	130	140	160			
<b>Case 1</b> ( $N_{Rk,c}^0$ has to be replaced by $N_{Rk,sp}^0$ )														
Characteristic resistance in uncracked concrete C20/25	$N_{Rk,sp}^0$	[kN]	7,5	-	16	16	20	25	25	30	30	30		
Spacing (edge distance)	$s_{cr,sp} (= 2 C_{cr,sp})$	[mm]	3 $h_{ef}$	-	3 $h_{ef}$	3 $h_{ef}$			3 $h_{ef}$					
<b>Case 2</b>														
Spacing (edge distance)	$s_{cr,sp} (= 2 C_{cr,sp})$	[mm]	6 $h_{ef}$	7 $h_{ef}$	6 $h_{ef}$	7 $h_{ef}$	7 $h_{ef}$	7 $h_{ef}$	6 $h_{ef}$	7 $h_{ef}$	6 $h_{ef}$	6 $h_{ef}$	6 $h_{ef}$	
Increasing factor for $N_{Rk,p}$ and $N_{Rk,sp}^0$	$\psi/c$	[-]	$\left(\frac{f_{ck,cube}}{25}\right)^{0,5}$											
<b>Concrete cone failure</b>														
Effective anchorage depth	$h_{ef} \geq$	[mm]	40	50	60	75	75	70	80	95	100	110	125	
Factor acc. to CEN/TS 1992-4	$k_{ucr}$	[-]	10,1											

<sup>1)</sup> Pull-out failure is not decisive

<sup>2)</sup> Maximum long term temperature / Maximum short term temperature

**Injection System VMZ**

**Performance**

Characteristic values for **tension loads, VMZ-A M8 – M12, uncracked concrete**, static and quasi-static action

**Annex C2**

**Table C4: Characteristic values for tension loads, VMZ-A M16 – M24, uncracked concrete, static and quasi-static action**

Anchor size VMZ-A			90 M16	105 M16	125 M16	145 M16	160 M16	115 M20	170 M20 (LG)	190 M20 (LG)	170 M24 (LG)	200 M24 (LG)	225 M24 (LG)
Installation safety factor	$\gamma_2 = \gamma_{inst}$	[-]	1,0										
<b>Steel failure</b>													
Characteristic tension resistance $N_{Rk,s}$	Steel, zinc plated	[kN]	88	95	111	111	97	96	188	188	222	222	222
	A4, HCR	[kN]	88	95	111	111	97	114	165	165	194	194	194
Partial safety factor	$\gamma_{Ms}$	[-]	1,5					1,68	1,5		1,5		
<b>Pull-out</b>													
Characteristic resistance $N_{Rk,p}$ in uncracked concrete C20/25	50°C / 80°C <sup>2)</sup>	[kN]	1)			75	90	1)			1)		
	72°C / 120°C <sup>2)</sup>	[kN]	25	35	50	50	53	40	75	75	95	95	95
<b>Splitting</b>													
Splitting for <b>standard thickness of concrete</b> (The higher resistance of Case 1 and Case 2 may be applied.)													
Standard thickness of concrete	$h_{std} \geq 2 h_{ef}$	[mm]	180	200	250	290	320	230	340	380	340	400	450
<b>Case 1</b> ( $N_{Rk,c}^0$ has to be replaced by $N_{Rk,sp}^0$ )													
Characteristic resistance in uncracked concrete C20/25	$N_{Rk,sp}^0$	[kN]	40	50	50	60	80	1)		115	1)		140
Spacing (edge distance)	$s_{cr,sp} (= 2 c_{cr,sp})$	[mm]	3 $h_{ef}$										
<b>Case 2</b>													
Spacing (edge distance)	$s_{cr,sp} (= 2 c_{cr,sp})$	[mm]	4 $h_{ef}$	4 $h_{ef}$	4 $h_{ef}$	4 $h_{ef}$	4 $h_{ef}$	3 $h_{ef}$	3 $h_{ef}$	4 $h_{ef}$	3 $h_{ef}$	3 $h_{ef}$	3,6 $h_{ef}$
Splitting for <b>minimum thickness of concrete</b> (The higher resistance of Case 1 and Case 2 may be applied.)													
Minimum thickness of concrete	$h_{min} \geq$	[mm]	130	150	160	180	200	160	220	240	220	260	290
<b>Case 1</b> ( $N_{Rk,c}^0$ has to be replaced by $N_{Rk,sp}^0$ )													
Characteristic resistance in uncracked concrete C20/25	$N_{Rk,sp}^0$	[kN]	35	50	40	50	71	-	75	75	1)		115
Spacing (edge distance)	$s_{cr,sp} (= 2 c_{cr,sp})$	[mm]	3 $h_{ef}$										
<b>Case 2</b>													
Spacing (edge distance)	$s_{cr,sp} (= 2 c_{cr,sp})$	[mm]	5 $h_{ef}$	5 $h_{ef}$	6 $h_{ef}$	5 $h_{ef}$	5 $h_{ef}$	5 $h_{ef}$	5,2 $h_{ef}$	4,4 $h_{ef}$	5,2 $h_{ef}$	4,4 $h_{ef}$	4,4 $h_{ef}$
Increasing factor for $N_{Rk,p}$ and $N_{Rk,sp}^0$	$\psi_C$	[-]	$\left(\frac{f_{ck,cube}}{25}\right)^{0,5}$										
<b>Concrete cone failure</b>													
Effective anchorage depth	$h_{ef} \geq$	[mm]	90	105	125	145	160	115	170	190	170	200	225
Factor acc. to CEN/TS 1992-4	$k_{ucr}$	[-]	10,1										

<sup>1)</sup> Pull-out failure is not decisive

<sup>2)</sup> Maximum long term temperature / Maximum short term temperature

### Injection System VMZ

#### Performance

Characteristic values for **tension loads, VMZ-A M16 – M24, uncracked concrete**, static and quasi-static action

**Annex C3**

**Table C5: Characteristic values for shear load, VMZ-A M8 – M12, cracked and uncracked concrete, static and quasi-static action**

Anchor size VMZ-A			40 M8	50 M8	60 M10	75 M10	75 M12	70 M12	80 M12	95 M12	100 M12	110 M12	125 M12
Installation safety factor	$\gamma_2 = \gamma_{inst}$	[-]	1,0										
<b>Steel failure without lever arm</b>													
Characteristic shear resistance $V_{Rk,s}$	Steel, zinc plated	[kN]	14	21	34								
	A4, HCR	[kN]	15	23	34								
Partial safety factor	$\gamma_{Ms}$	[-]	1,25										
Factor for ductility	$k_2$	[-]	1,0										
<b>Steel failure with lever arm</b>													
Characteristic bending moments $M^0_{Rk,s}$	Steel, zinc plated	[Nm]	30	60	105								
	A4, HCR	[Nm]	30	60	105								
Partial safety factor	$\gamma_{Ms}$	[-]	1,25										
<b>Concrete pry-out failure</b>													
Factor k acc. ETAG 001, Annex C or $k_3$ acc. CEN/TS 1992-4	$k_{(3)}$	[-]	2										
<b>Concrete edge failure</b>													
Effective length of anchor in shear load	$l_f$	[mm]	40	50	60	75	75	70	80	95	100	110	125
Diameter of anchor	$d_{nom}$	[mm]	10	12	12	14							

**Injection System VMZ**

**Performance**  
 Characteristic values for **shear load, VMZ-A M8 – M12, cracked and uncracked concrete**, static and quasi-static action

**Annex C4**

**Table C6: Characteristic values for shear load, VMZ-A M16 – M24, cracked and uncracked concrete, static and quasi-static action**

Anchor size VMZ-A		90 M16	105 M16	125 M16	145 M16	160 M16	115 M20	170 M20 (LG)	190 M20 (LG)	170 M24 (LG)	200 M24 (LG)	225 M24 (LG)
Installation safety factor	$\gamma_2 = \gamma_{inst}$ [-]	1,0										
<b>Steel failure without lever arm</b>												
Characteristic shear resistance $V_{Rk,s}$	Steel, zinc plated	[kN]	63				70	149 <sup>1)</sup> (98)		178 <sup>1)</sup> (141)		
	A4, HCR	[kN]	63				86	131 <sup>1)</sup> (86)		156 <sup>1)</sup> (123)		
Partial safety factor	$\gamma_{Ms}$ [-]	1,25				1,4	1,25		1,25			
Factor for ductility	$k_2$ [-]	1,0										
<b>Steel failure with lever arm</b>												
Characteristic bending moments $M^0_{Rk,s}$	Steel, zinc plated	[Nm]	266				392	519		896		
	A4, HCR	[Nm]	266					454		784		
Partial safety factor	$\gamma_{Ms}$ [-]	1,25				1,4	1,25		1,25			
<b>Concrete pry-out failure</b>												
Factor k acc. ETAG 001, Annex C or $k_3$ acc. CEN/TS 1992-4	$k_{(3)}$ [-]	2										
<b>Concrete edge failure</b>												
Effective length of anchor in shear load	$l_f$ [mm]	90	105	125	145	160	115	170	190	170	200	225
Diameter of anchor	$d_{nom}$ [mm]	18				22	24		26			

<sup>1)</sup> This value may only be applied if  $l_t \geq 0,5 t_{fix}$

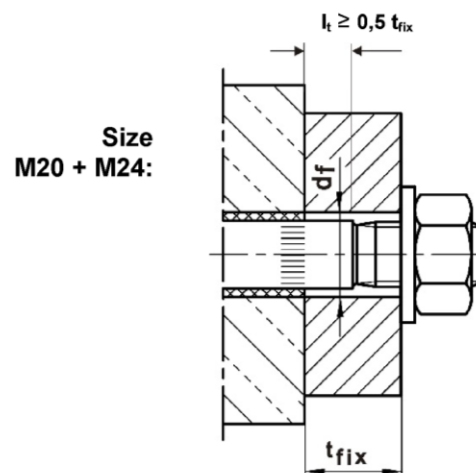

**Injection System VMZ**

**Performance**

Characteristic values for **shear load, VMZ-A M16 – M24, cracked and uncracked concrete**, static and quasi-static action

**Annex C5**

**Table C7: Characteristic resistances for seismic loading  
VMZ-A M10 – M12 performance category C1 and C2**

Anchor size VMZ-A			60 M10	75 M10	75 M12	70 M12	80 M12	95 M12	100 M12	110 M12	125 M12
<b>Tension loads</b>											
Installation safety factor	$\gamma_2 = \gamma_{inst}$	[-]	1,0								
<b>Steel failure, steel zinc plated</b>											
Characteristic resistance C1	$N_{Rk,s,seis,C1}$	[kN]	25	35	49	54	57				
Characteristic resistance C2	$N_{Rk,s,seis,C2}$	[kN]	25	35	49	54	57				
<b>Steel failure, stainless steel A4, HCR</b>											
Characteristic resistance C1	$N_{Rk,s,seis,C1}$	[kN]	25	35	49	54	57				
Characteristic resistance C2	$N_{Rk,s,seis,C2}$	[kN]	25	35	49	54	57				
Partial safety factor	$\gamma_{Ms,seis}$	[-]	1,5								
<b>Pull-out</b>											
Characteristic resistance C1	$N_{Rk,p,seis,C1}$	50°C / 80°C <sup>1)</sup>	[kN]	14,5	14,5	30,6	36,0	41,5	42,8		
		72°C / 120°C <sup>1)</sup>	[kN]	10,9	10,9	20,0	30,0				
Characteristic resistance C2	$N_{Rk,p,seis,C2}$	50°C / 80°C <sup>1)</sup>	[kN]	7,4	7,4	8,7	17,6				
		72°C / 120°C <sup>1)</sup>	[kN]	5,1	5,1	6,5	12,3				

<b>Shear loads</b>											
<b>Steel failure without lever arm, steel zinc plated</b>											
Characteristic resistance C1	$V_{Rk,s,seis,C1}$	[kN]	11,8	27,2							
Characteristic resistance C2	$V_{Rk,s,seis,C2}$	[kN]	12,6	27,2							
Partial safety factor	$\gamma_{Ms,seis}$	[-]	1,25								
<b>Steel failure without lever arm, stainless steel A4, HCR</b>											
Characteristic resistance C1	$V_{Rk,s,seis,C1}$	[kN]	12,9	27,2							
Characteristic resistance C2	$V_{Rk,s,seis,C2}$	[kN]	13,8	27,2							
Partial safety factor	$\gamma_{Ms,seis}$	[-]	1,25								
<b>Steel failure with lever arm</b>											
Characteristic bending moment C1	$M^0_{Rk,s,seis,C1}$	[Nm]	no performance determined								
Characteristic bending moment C2	$M^0_{Rk,s,seis,C2}$	[Nm]	no performance determined								

<sup>1)</sup> Maximum long term temperature / Maximum short term temperature

<b>Injection System VMZ</b>	<b>Annex C6</b>
<b>Performance</b> Characteristic resistances for seismic loading, VMZ-A M10 – M12, performance category C1 and C2	

**Table C8: Characteristic resistances for seismic loading  
VMZ-A M16 – M24 performance category C1 and C2**

Anchor size VMZ-A		90 M16	105 M16	125 M16	145 M16	160 M16	115 M20	170 M20 (LG)	190 M20 (LG)	170 M24 (LG)	200 M24 (LG)	225 M24 (LG)
<b>Tension loads</b>												
Installation safety factor	$\gamma_2 = \gamma_{inst}$	[-]										
<b>Steel failure, steel zinc plated</b>												
Characteristic resistance C1	$N_{Rk,s,seis,C1}$	[kN]	88	95	111	97	96	188	222			
Characteristic resistance C2	$N_{Rk,s,seis,C2}$	[kN]	88	95	111	97	96	188	222			
<b>Steel failure, stainless steel A4, HCR</b>												
Characteristic resistance C1	$N_{Rk,s,seis,C1}$	[kN]	88	95	111	97	114	165	194			
Characteristic resistance C2	$N_{Rk,s,seis,C2}$	[kN]	88	95	111	97	114	165	194			
Partial safety factor	$\gamma_{Ms,seis}$	[-]										
<b>Pull-out</b>												
Characteristic resistance C1	$N_{Rk,p,seis,C1}$	50°C / 80°C <sup>1)</sup>	[kN]	30,7	38,7	43,7		44,4	88,2	90,7		
		72°C / 120°C <sup>1)</sup>	[kN]	25,0	30,0	38,5		29,4	55,8	59,3		
Characteristic resistance C2	$N_{Rk,p,seis,C2}$	50°C / 80°C <sup>1)</sup>	[kN]	16,3	22,1	26,1		30,9	59,7	59,7		
		72°C / 120°C <sup>1)</sup>	[kN]	10,5	14,4	19,5		16,2	44,4	44,4		

<b>Shear loads</b>												
<b>Steel failure without lever arm, steel zinc plated</b>												
Characteristic resistance C1	$V_{Rk,s,seis,C1}$	[kN]	39,1				39,1	82,3	107			
Characteristic resistance C2	$V_{Rk,s,seis,C2}$	[kN]	50,4				51,0	108,8 <sup>1)</sup> (71,5)	154,9 <sup>1)</sup> (122,7)			
Partial safety factor	$\gamma_{Ms,seis}$	[-]										
<b>Steel failure without lever arm, stainless steel A4, HCR</b>												
Characteristic resistance C1	$V_{Rk,s,seis,C1}$	[kN]	39,1				39,1	72,2	93			
Characteristic resistance C2	$V_{Rk,s,seis,C2}$	[kN]	50,4				62,6	95,6 <sup>1)</sup> (62,8)	135,7 <sup>1)</sup> (107)			
Partial safety factor	$\gamma_{Ms,seis}$	[-]										
<b>Steel failure with lever arm</b>												
Characteristic bending moment C1	$M^0_{Rk,s,seis,C1}$	[Nm]	no performance determined									
Characteristic bending moment C2	$M^0_{Rk,s,seis,C2}$	[Nm]	no performance determined									

<sup>1)</sup> This value may only be applied if  $l_t \geq 0,5 t_{fix}$ , (see Annex C5)

<b>Injection System VMZ</b>	<b>Annex C7</b>
<b>Performance</b> Characteristic resistances for seismic loading, VMZ-A M16 – M24, performance category C1 and C2	

**Table C9: Displacements under tension loads, VMZ-A M8 – M12**

Anchor size VMZ-A			40 M8	50 M8	60 M10	75 M10	75 M12	70 M12	80 M12	95 M12	100 M12	110 M12	125 M12
Tension load in cracked concrete	N	[kN]	4,3	6,1	8,0	11,1	11,1	10,0	12,3	15,9	17,1	19,8	24,0
Displacement	$\delta_{N0}$	[mm]	0,5	0,5	0,5	0,6	0,6	0,6	0,6	0,6	0,6	0,7	0,7
	$\delta_{N\infty}$	[mm]	1,3										
Tension load in uncracked concrete	N	[kN]	4,3	8,5	11,1	15,6	15,6	14,1	17,2	19,0	24,0	23,8	23,8
Displacement	$\delta_{N0}$	[mm]	0,2	0,4	0,4	0,4	0,4	0,4	0,4	0,4	0,4	0,6	0,6
	$\delta_{N\infty}$	[mm]	1,3										
Displacements under seismic tension loads <b>C2</b>													
Displacements for DLS	$\delta_{N,seis,C2(DLS)}$	[mm]	-	-	1,0		1,0		1,3		1,1		
Displacements for ULS	$\delta_{N,seis,C2(ULS)}$	[mm]	-	-	3,0		3,0		3,9		3,0		

**Table C10: Displacements under tension loads, VMZ-A M16 – M24**

Anchor size VMZ-A			90 M16	105 M16	125 M16	145 M16	160 M16	115 M20	170 M20 (LG)	190 M20 (LG)	170 M24 (LG)	200 M24 (LG)	225 M24 (LG)
Tension load in cracked concrete	N	[kN]	14,6	18,4	24,0	30,0	34,7	21,1	38,0	44,9	38,0	48,5	57,9
Displacement	$\delta_{N0}$	[mm]	0,7	0,7	0,7	0,8	1,2	0,7	0,8	0,8	0,8	0,9	0,9
	$\delta_{N\infty}$	[mm]	1,3				1,6	1,1	1,3		1,3		
Tension load in uncracked concrete	N	[kN]	20,5	25,9	33,0	35,7	48,1	29,6	53,3	63,0	53,3	67,9	81,1
Displacement	$\delta_{N0}$	[mm]	0,6	0,6	0,6	0,6	0,8	0,5	0,6	0,6	0,6	0,6	0,6
	$\delta_{N\infty}$	[mm]	1,3				1,6	1,1	1,3		1,3		
Displacements under seismic tension loads <b>C2</b>													
Displacements for DLS	$\delta_{N,seis,C2(DLS)}$	[mm]	1,6		1,5			1,7	1,9		1,9		
Displacements for ULS	$\delta_{N,seis,C2(ULS)}$	[mm]	3,7		4,4			4,0	4,5		4,5		

**Injection System VMZ**

**Performance**  
Displacements under tension loads, **VMZ-A**

**Annex C8**

**Table C11: Displacements under shear loads VMZ-A M8 – M12**

Anchor size VMZ-A			40 M8	50 M8	60 M10	75 M10	75 M12	70 M12	80 M12	95 M12	100 M12	110 M12	125 M12
Shear load	V	[kN]	8,3		13,3		19,3						
Displacements	$\delta_{V0}$	[mm]	2,4	2,5	2,9		3,3						
	$\delta_{V\infty}$	[mm]	3,6	3,8	4,4		5,0						
<b>Displacements under seismic shear loads C2</b>													
Displacements for DLS	$\delta_{V,seis,C2(DLS)}$	[mm]	-	-	2,1		2,5						
Displacements for ULS	$\delta_{V,seis,C2(ULS)}$	[mm]	-	-	3,7		5,1						

**Table C12: Displacements under shear loads VMZ-A M16 – M24**

Anchor size VMZ-A			90 M16	105 M16	125 M16	145 M16	160 M16	115 M20	170 M20 (LG)	190 M20 (LG)	170 M24 (LG)	200 M24 (LG)	225 M24 (LG)
Shear load	V	[kN]	36				44	75 (49)		89 (71)			
Displacements	$\delta_{V0}$	[mm]	3,8				3,0	4,3 (3,0)		4,6 (3,5)			
	$\delta_{V\infty}$	[mm]	5,7				4,5	6,5 (4,5)		6,9 (5,3)			
<b>Displacements under seismic shear loads C2</b>													
Displacements for DLS	$\delta_{V,seis,C2(DLS)}$	[mm]	2,9				3,5		3,7				
Displacements for ULS	$\delta_{V,seis,C2(ULS)}$	[mm]	6,8				9,3		9,3				

**Injection System VMZ**

**Performance**  
Displacements under shear loads, **VMZ-A**

**Annex C9**



**Table C13: Characteristic values for tension load, VMZ-IG , cracked concrete**

Anchor size VMZ-IG			40 M6	50 M6	60 M8	75 M8	70 M10	80 M10	90 M12	105 M12	125 M12	115 M16	170 M16	170 M20	
Installation safety factor	$\gamma_2 = \gamma_{inst}$	[-]	1,0												
<b>Steel failure</b>															
Characteristic tension resistance $N_{Rk,s}$	Steel, zinc plated	[kN]	15	16	19	29	35			67			52	125	108
	A4, HCR	[kN]	11		19	21	33			47			65	88	94
Partial safety factor	$\gamma_{Ms}$	[-]	1,5												
<b>Pull-out</b>															
Characteristic resistance $N_{Rk,p}$ in cracked concrete C20/25	50°C / 80°C <sup>2)</sup>	[kN]	1)												
	72°C / 120°C <sup>2)</sup>	[kN]	5	7,5	12		16	20	20	30	50	30	60	75	
Increasing factor	$\psi_c$	[-]	$\left(\frac{f_{ck,cube}}{25}\right)^{0,5}$												
<b>Concrete cone failure</b>															
Effective anchorage depth	$h_{ef}$	[mm]	40	50	60	75	70	80	90	105	125	115	170	170	
Factor according to CEN/TS 1992-4	$k_{cr}$	[-]	7,2												

<sup>1)</sup> Pull-out failure is not decisive

<sup>2)</sup> Maximum long term temperature / Maximum short term temperature

<b>Injection System VMZ</b>	<b>Annex C10</b>
<b>Performance</b> Characteristic values for <b>tension load, VMZ-IG, cracked concrete</b>	

**Table C14: Characteristic values for tension load, VMZ-IG, uncracked concrete**

Anchor size VMZ-IG			40 M6	50 M6	60 M8	75 M8	70 M10	80 M10	90 M12	105 M12	125 M12	115 M16	170 M16	170 M20	
Installation safety factor	$\gamma_2 = \gamma_{inst}$	[-]	1,0												
<b>Steel failure</b>															
Characteristic tension resistance $N_{RK,s}$	Steel, zinc plated	[kN]	15	16	19	29	35			67			52	125	108
	A4, HCR	[kN]	11		19	21	33			47			65	88	94
Partial safety factor	$\gamma_{Ms}$	[-]	1,5												
<b>Pull-out</b>															
Characteristic resistance $N_{RK,p}$ in uncracked concrete C20/25	50°C / 80°C <sup>2)</sup>	[kN]	9	1)		1)									
	72°C / 120°C <sup>2)</sup>	[kN]	6	9	16		16	25	25	35	50	40	75	95	
<b>Splitting</b>															
<b>Splitting for standard thickness of concrete</b> (The higher resistance of Case 1 and Case 2 may be applied.)															
Standard thickness of concrete	$h_{std} \geq 2h_{ef}$	[mm]	100	120	150	140	160	180	200	250	230	340	340		
<b>Case 1</b> ( $N_{RK,c}^0$ has to be replaced by $N_{RK,sp}^0$ )															
Characteristic resistance in concrete C20/25	$N_{RK,sp}^0$	[kN]	7,5	9	16	20	20	1)	40	50	50	1)	1)		
Spacing (edge distance)	$s_{cr,sp} (= 2 C_{cr,sp})$	[mm]	3 $h_{ef}$												
<b>Case 2</b>															
Spacing (edge distance)	$s_{cr,sp} (= 2 C_{cr,sp})$	[mm]	6 $h_{ef}$	6 $h_{ef}$	5 $h_{ef}$	7 $h_{ef}$	5 $h_{ef}$	3 $h_{ef}$	4 $h_{ef}$	4 $h_{ef}$	4 $h_{ef}$	3 $h_{ef}$	3 $h_{ef}$	3 $h_{ef}$	
<b>Splitting for minimum thickness of concrete</b> (The higher resistance of Case 1 and Case 2 may be applied.)															
Minimum thickness of concrete	$h_{min} \geq$	[mm]	80	100	110	110			130	150	160	160	220	220	
<b>Case 1</b> ( $N_{RK,c}^0$ has to be replaced by $N_{RK,sp}^0$ )															
Characteristic resistance in concrete C20/25	$N_{RK,sp}^0$	[kN]	7,5	-	16		20	25	35	50	40	-	75	1)	
Spacing (edge distance)	$s_{cr,sp} (= 2 C_{cr,sp})$	[mm]	3 $h_{ef}$												
<b>Case 2</b>															
Spacing (edge distance)	$s_{cr,sp} (= 2 C_{cr,sp})$	[mm]	6 $h_{ef}$	7 $h_{ef}$	6 $h_{ef}$	7 $h_{ef}$	7 $h_{ef}$	6 $h_{ef}$	5 $h_{ef}$	5 $h_{ef}$	6 $h_{ef}$	5 $h_{ef}$	5,2 $h_{ef}$	5,2 $h_{ef}$	
Increasing factor for $N_{RK,p}$ and $N_{RK,sp}^0$	$\psi_c$	[-]	$\left(\frac{f_{ck,cube}}{25}\right)^{0,5}$												
<b>Concrete cone failure</b>															
Effective anchorage depth	$h_{ef}$	[mm]	40	50	60	75	70	80	90	105	125	115	170	170	
Factor according to CEN/TS 1992-4	$k_{ucr}$	[-]	10,1												

<sup>1)</sup> Pull-out failure is not decisive

<sup>2)</sup> Maximum long term temperature / Maximum short term temperature

**Injection System VMZ**

**Performance**

Characteristic values for tension loads, VMZ-IG, uncracked concrete

**Annex C11**

**Table C15: Characteristic values for shear load, VMZ-IG, cracked and uncracked concrete**

Anchor size VMZ-IG			40 M6	50 M6	60 M8	75 M8	70 M10	80 M10	90 M12	105 M12	125 M12	115 M16	170 M16	170 M20
Installation safety factor	$\gamma_2 = \gamma_{inst}$	[-]	1,0											
<b>Steel failure without lever arm</b>														
Characteristic shear resistance $V_{Rk,s}$	Steel, zinc plated	[kN]	8,0	9,5	15	18	34			26	63	54		
	A4, HCR	[kN]	5,5	9,5	10	16	24			32	44	47		
Partial safety factor	$\gamma_{Ms}$	[-]	1,25											
Factor for ductility	$k_2$	[-]	1,0											
<b>Steel failure with lever arm</b>														
Characteristic bending moments $M_{Rk,s}^0$	Steel, zinc plated	[kN]	12	30	60	105	212	266	519					
	A4, HCR	[kN]	8,5	21	42	74	187	187	365					
Partial safety factor	$\gamma_{Ms}$	[-]	1,25											
<b>Concrete pry-out failure</b>														
Factor k acc. ETAG 001, Annex C or $k_3$ acc. CEN/TS 1992-4	$k_{(3)}$	[-]	2											
<b>Concrete edge failure</b>														
Effective length of anchor in shear load	$l_f$	[mm]	40	50	60	75	70	80	90	105	125	115	170	170
Diameter of anchor	$d_{nom}$	[mm]	10	12	14	18	22	24	26					

**Table C16: Displacements under tension loads, VMZ-IG**

Anchor size VMZ-IG			40 M6	50 M6	60 M8	75 M8	70 M10	80 M10	90 M12	105 M12	125 M12	115 M16	170 M16	170 M20
Tension load in <b>cracked</b> concrete	N	[kN]	4,3	6,1	8,0	11,1	10,0	12,3	14,6	18,4	24,0	21,1	38,0	38,0
Displacement	$\delta_{N0}$	[mm]	0,5	0,5	0,6	0,6	0,7			0,7	0,8	0,8		
	$\delta_{N\infty}$	[mm]	1,3									1,1	1,3	1,3
Tension load in <b>uncracked</b> concrete	N	[kN]	4,3	8,5	11,1	15,6	14,1	17,2	20,5	25,9	33,0	29,6	53,3	53,3
Displacement	$\delta_{N0}$	[mm]	0,2	0,4	0,4	0,4	0,6			0,5	0,6	0,6		
	$\delta_{N\infty}$	[mm]	1,3									1,1	1,3	1,3

**Table C17: Displacements under shear loads, VMZ-IG**

Anchor size VMZ-IG			40 M6	50 M6	60 M8	75 M8	70 M10	80 M10	90 M12	105 M12	125 M12	115 M16	170 M16	170 M20
Shear load	V	[kN]	4,6	5,4	8,4	10,1	19,3			14,8	35,8	30,7		
Displacement	$\delta_{V0}$	[mm]	0,4	0,5	0,4	0,5	1,2			0,8	1,9	1,2		
	$\delta_{V\infty}$	[mm]	0,7	0,8	0,7	0,8	1,9			1,2	2,8	1,9		
Shear load	V	[kN]	3,2	5,4	5,9	9,3	13,5			18,5	25,2	26,9		
Displacement	$\delta_{V0}$	[mm]	0,3	0,5	0,3	0,5	0,9			1,0	1,4	1,1		
	$\delta_{V\infty}$	[mm]	0,4	0,7	0,5	0,7	1,4			1,5	2,1	1,6		

<b>Injection System VMZ</b>	<b>Annex C12</b>
<b>Performance</b> Characteristic values for <b>shear load, VMZ-IG, cracked and uncracked concrete, Displacements</b>	