

TELJESÍTMÉNYNYILATKOZAT

DoP Száma: **MKT-2.4-102_hu**

- ◇ **A terméktípus egyedi azonosító kódja:** **VMZ dynamic befecskendezési rendszer**
- ◇ **Felhasználás célja(i):** Utószerelt kötőelemek betonba fáradással összefüggő ciklikus terhelés alatt, lásd a B. Mellékletet / Annex B
- ◇ **Gyártó:** MKT Metall-Kunststoff-Technik GmbH & Co.KG
Auf dem Immel 2
67685 Weilerbach
- ◇ **Az AVCP-rendszer(ek):** 1
- ◇ **Az európai értékelési dokumentum:** **EAD 330250-00-0601**
Európai műszaki értékelés: **ETA-17/0194, 14.03.2023**
A műszaki értékelést végző szerv: DIBt, Berlin
Bejelentett szerv(ek): NB 2873 – Technische Universität Darmstadt
- ◇ **A nyilatkozatban szereplő teljesítmény(ek):**

Alapvető tulajdonságok	Teljesítmény
Mechanikai szilárdság és állékonyság (BWR 1)	
Jellemző ellenállás húzóterhelés mellett (statikus és kvázi-statikuss hatások)	Melléklet/Annex B2, B3, C4
Jellemző ellenállás keresztirányú feszültség alatt (statikus és kvázi-statikuss hatások)	Melléklet/Annex C5
Eltolódásokat (statikus és kvázi-statikuss hatások)	Melléklet/Annex C6
Jellemző ellenállás és elmozdulások a szeizmikus teljesítménykategória C1 + C2 esetében	Melléklet/Annex C4 – C6
Jellemző fáradtság-ellenállás ciklikus húzófeszültség alatt	Melléklet/Annex C1 – C3
Jellemző fáradtság-ellenállás ciklikus keresztirányú terheléseknél	
Jellemző fáradtság-ellenállás ciklikus kombinált feszültség és nyírási terhelés mellett	
Terhelés átviteli tényező ciklikus húzó- és keresztirányú terheléseknél	
Higiénia, egészség és környezetvédelem (BWR 3)	
Veszélyes anyagok tartalma, kibocsátása és / vagy kibocsátása	A teljesítmény nem lett besorolva

A fent azonosított termék teljesítménye megfelel a bejelentett teljesítmény(ek)nek. A 305/2011/EU rendeletnek megfelelően e teljesítménynyilatkozat kiadásáért kizárólag a fent meghatározott gyártó a felelős.

A gyártó nevében és részéről aláíró személy:

Stefan Weustenhagen
(Vezérigazgató)
Weilerbach, 14.03.2023

p.p. 
Dipl.-Ing. Detlef Bigalke
(A termékfejlesztés vezetője)



A teljesítménynyilatkozat eredeti példányát németül írták. A fordítás eltérése esetén a német változat érvényes.

Specifications of intended use

Injection System VMZ dynamic	100 M12	125 M16	170 M20
Fatigue cyclic loading		✓	
Static and quasi-static action		✓	
Seismic action (Category C1 + C2)		✓	
Cracked or uncracked concrete		✓	
Strength classes acc. to EN 206:2013+A1:2016		C20/25 to C50/60	
Compacted reinforced or unreinforced normal weight concrete without fibers acc. to EN 206:2013+A1:2016		✓	
Temperature range I	-40 °C to +80 °C	maximum long-term temperature +50 °C maximum short-term temperature +80 °C	

Use conditions (Environmental conditions):

- Structures subject to dry internal conditions: all materials
- For all other conditions:
Intended use of materials according to Annex A4, Table A1 corresponding to the corrosion resistance class CRC to EN 1993-1-4:2015

Design:

- Anchorage are designed under the responsibility of an engineer experienced in anchorages and concrete work.
- Verifiable calculation notes and drawings are prepared taking account of the loads to be anchored. The position of the anchor is indicated on the design drawings (e.g. position of the anchor relative to reinforcement or to supports, etc.)
- Anchorage are designed according to:
 - EOTA TR 061:2020 (Design method I and II) or
 - EN 1992-4:2018

Installation:

- Anchor shall only be used as a complete fastening unit delivered in series. Components of the anchor must not be replaced.
- Anchor installation carried out by appropriately qualified personnel and under the supervision of the site manager.
- Installation admissible in dry and wet concrete and in water-filled borehole.
- Drill hole must be cleaned directly prior to installation of the anchor or the drill hole has to be protected against re-contamination in an appropriate way until dispensing the mortar in the drill hole.
- Water filled drill holes must not be polluted – otherwise the cleaning of the drill hole must be repeated.
- The anchor component installation temperature shall be at least +5 °C; during curing of the injection mortar the temperature of the concrete must not fall below -15 °C (for the standard variation of temperature after installation).
- It must be ensured that icing does not occur in the drill hole.
- Installation direction D3: vertically downwards and upwards as well as horizontally.
- Drilling by hammer drill bit, compressed air drill or vacuum drill bit.
- The filling of the annular gap can be omitted if it is ensured that the anchor is only loaded in axial direction.

Injection System VMZ dynamic

Intended use
Specifications

Annex B1

Table B1: Installation parameters

Anchor size / version			100 M12	100 M12 A4 100 M12 HCR	125 M16	125 M16 A4 125 M16 HCR	170 M20
Effective anchorage depth	$h_{ef} \geq$	[mm]	100		125		170
Nominal diameter of drill hole	$d_0 =$	[mm]	14		18		24
Depth of drill hole ¹⁾	$h_0 \geq$	[mm]	105		130		180
Diameter of cleaning brush	$D \geq$	[mm]	15,0		19,0		25,0
Installation torque	$T_{inst} =$	[Nm]	30		50		80
Diameter of clearance hole in the fixture	$d_f =$	[mm]	15		19		25
Fixture thickness ²⁾	$t_{fix,min} \geq$	[mm]	12		16		20
	$t_{fix,max} \leq$	[mm]	200				
Overstand	$h_p =$	[mm]	$31 + t_{fix}$	$24 + t_{fix}$	$39 + t_{fix}$	$30 + t_{fix}$	$48 + t_{fix}$

¹⁾ If the present fixture thickness is lower than the maximum fixture thickness of the anchor, the depth of drill hole should be increased accordingly

²⁾ $t_{fix,min}$ may be replaced by $t_{fix,min,red}$, if, when determining the anchor under the highest load, the action ΔV_{Ed} is smaller than the fatigue resistance in transverse direction

$$t_{fix,min,red} = \left(0,5 + 0,5 \cdot \frac{\Delta V_{Ed}}{\Delta V_{Rd,s,E,n} * \psi_{FV}} \right) \cdot t_{fix,min}$$

Pre-setting installation

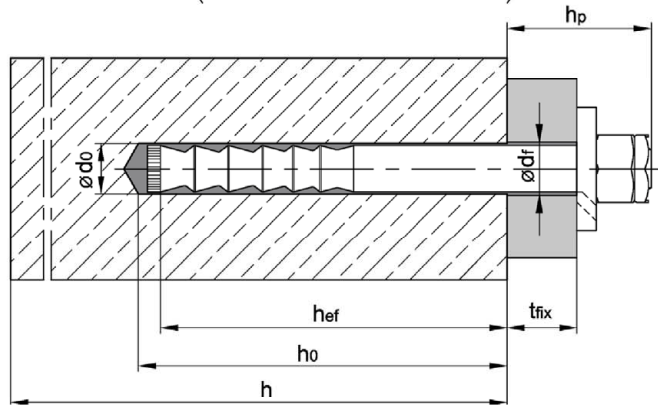

Through-setting installation

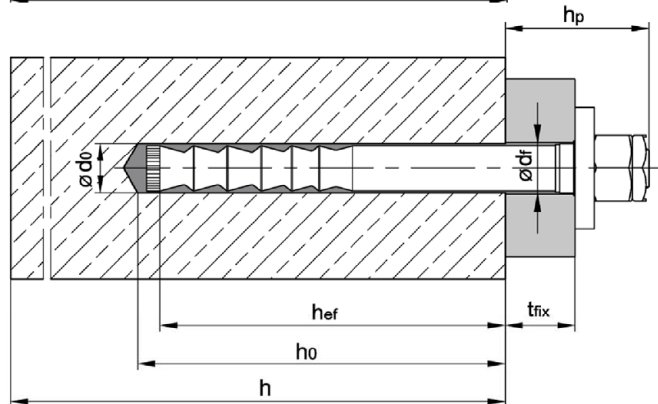

Injection System VMZ dynamic

Intended use
Installation parameters

Annex B2

Table B2: Minimum thickness of concrete and minimum spacing and edge distance

Anchor size			100 M12	125 M16	170 M20
Minimum thickness of concrete member	h_{min}	[mm]	130	160	220
Cracked concrete					
Minimum spacing	s_{min}	[mm]	50	60	80
Minimum edge distance ¹⁾	c_{min}	[mm]	70 (50)	80 (60)	110 (80)
Uncracked concrete					
Minimum spacing	s_{min}	[mm]	80	60	80
Minimum edge distance	c_{min}	[mm]	75	80	110

¹⁾ Values in brackets are valid if edge reinforcement $d = 8$ mm is installed

Injection System VMZ dynamic

Intended use
Minimum thickness of concrete, spacing and edge distances

Annex B3

Table B3: Processing time and curing time, VMZ

Temperature in the drill hole	Maximum processing time	Minimum curing time in dry concrete ¹⁾
- 15 °C to - 10 °C	45 min	7 d
- 9 °C to - 5 °C	45 min	10:30 h
- 4 °C to - 1 °C	45 min	6:00 h
0 °C to + 4 °C	20 min	3:00 h
+ 5 °C to + 9 °C	12 min	2:00 h
+ 10 °C to + 19 °C	6 min	1:20 h
+ 20 °C to + 29 °C	4 min	45 min
+ 30 °C to + 34 °C	2 min	25 min
+ 35 °C to + 39 °C	1,4 min	20 min
+ 40 °C	1,4 min	15 min
Cartridge temperature $\geq 5^{\circ}\text{C}$		

¹⁾ Curing time in wet concrete shall be doubled

Table B4: Processing time and curing time, VMZ express

Temperature in the drill hole	Maximum processing time	Minimum curing time in dry concrete ¹⁾
- 5 °C to - 1 °C	20 min	4:00 h
0 °C to + 4 °C	10 min	2:00 h
+ 5 °C to + 9 °C	6 min	1:00 h
+ 10 °C to + 19 °C	3 min	40 min
+ 20 °C to + 29 °C	1 min	20 min
+ 30 °C	1 min	10 min
Cartridge temperature $\geq 5^{\circ}\text{C}$		

¹⁾ Curing time in wet concrete shall be doubled

Injection System VMZ dynamic

Intended use
Processing time and curing time

Annex B4

Installation instructions – Through-setting installation

Hole drilling		
1		Drill hole perpendicular to concrete surface with hammer drill, compressed air drill or vacuum drill bit.
Cleaning		Drill hole must be cleaned directly prior to installation of the anchor
all sizes		<u>Cleaning with compressed air</u>
2a		Connect Air Blower to compressed air (min. 6 bar, oil-free). Open air valve and blow out drill hole along the entire depth with back and forth motion at least two times .
2b		Check diameter of Cleaning Brush. If brush can be pushed into the drill hole without any resistance, it must be replaced. Chuck brush into drill machine. Turn on drill machine. Brush drill hole back and forth along the entire drill hole depth at least two times while rotated by drill machine.
2c		Connect Air Blower to compressed air (min. 6 bar, oil-free). Open air valve and blow out drill hole along the entire depth with back and forth motion at least two times .
2	M12 - M16	<u>Manual cleaning</u> (alternative cleaning method)
2a		Blow out drill hole from the bottom using Blow-out Pump at least two times .
2b		Check diameter of Cleaning Brush. If brush can be pushed into the drill hole without any resistance, it must be replaced. Chuck brush into drill machine. Turn on drill machine. Brush drill hole back and forth along the entire drill hole depth at least two times while rotated by drill machine.
2c		Blow out drill hole from the bottom using Blow-out Pump at least two times .

Injection System VMZ dynamic

Intended use

Installation instructions – Through-setting installation

Annex B5

Installation instructions – Through-setting installation (continuation)

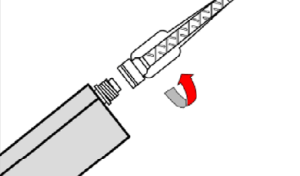
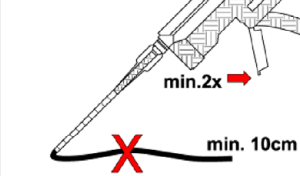
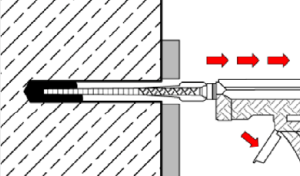
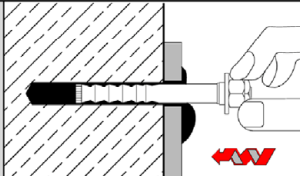
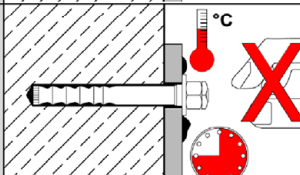
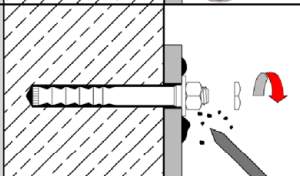
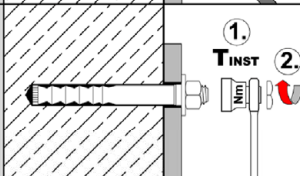
Injection		
3		Check minimum shelf-life on VMZ cartridge. Never use when expired. Remove cap from VMZ cartridge. Screw static mixer on cartridge. When using a new cartridge always use a new static mixer. Never use cartridge without static mixer and never use static mixer without helix inside.
4		Insert cartridge in dispenser. Before injecting discard mortar (at least 2 full strokes or a line of 10 cm) until it shows a consistent grey colour. Never use this mortar.
5		Prior to injection, check if static mixer reaches the bottom of the drill hole. If it does not reach the bottom, plug mixer extension onto static mixer, in order to properly fill the drill hole. Fill hole with a sufficient quantity of injection mortar. Start from the bottom of the drill hole and work out to avoid trapping air pockets.
Insertion of anchor rod		
6		Insert the pre-assembled anchor within processing time by hand, rotating slightly up to the full embedment depth, until the conical washer is in contact with the fixture. The anchor rod is properly set when the annular gap between anchor rod and fixture is completely filled. If no mortar is visible on the surface of the fixture, pull out the anchor rod immediately, let the mortar cure, drill out the hole and start again from step 2.
7		Follow minimum curing time shown in Annex B4 as well as on cartridge label. During curing time anchor rod must not be moved or loaded.
8		Remove excess mortar after curing time. Remove locknut.
9		1. Apply installation torque T_{INST} according to Table B1 by using torque wrench. 2. Screw on locknut until hand tight then tighten $\frac{1}{4}$ to $\frac{1}{2}$ turn using a screw wrench.

Injection System VMZ dynamic

Intended use
Installation instructions – Through-setting installation (continuation)

Annex B6

Installation instructions – Pre-setting installation

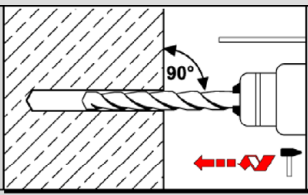
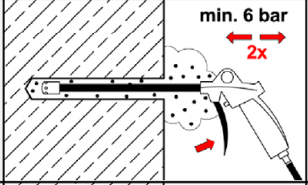
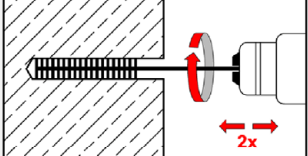
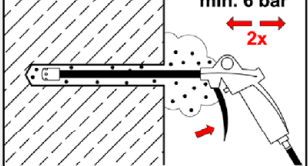
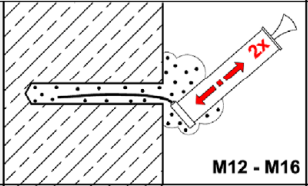
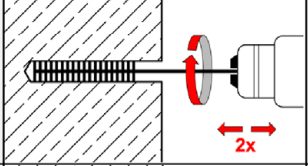
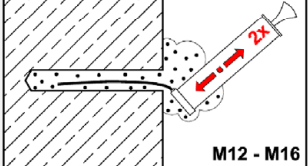
Hole drilling	
1	 <p>Drill perpendicular to concrete surface with hammer drill, vacuum drill or compressed air drill.</p>
Cleaning Drill hole must be cleaned directly prior to installation of the anchor	
all sizes Cleaning with compressed air	
2a	 <p>Connect Air Blower to compressed air (min. 6 bar, oil-free). Open air valve and blow out drill hole along the entire depth with back and forth motion at least two times.</p>
2b	 <p>Check diameter of Cleaning Brush. If brush can be pushed into the drill hole without any resistance, it must be replaced. Chuck brush into drill machine. Turn on drill machine. Brush drill hole back and forth along the entire drill hole depth at least two times while rotated by drill machine.</p>
2c	 <p>Connect Air Blower to compressed air (min. 6 bar, oil-free). Open air valve and blow out drill hole along the entire depth with back and forth motion at least two times.</p>
2	M12 - M16 Manual cleaning (alternative cleaning method)
2a	 <p>Blow out drill hole from the bottom using Blow-out Pump at least two times.</p>
2b	 <p>Check diameter of Cleaning Brush. If brush can be pushed into the drill hole without any resistance, it must be replaced. Chuck brush into drill machine. Turn on drill machine. Brush drill hole back and forth along the entire drill hole depth at least two times while rotated by drill machine.</p>
2c	 <p>Blow out drill hole from the bottom using Blow-out Pump at least two times.</p>

Injection System VMZ dynamic

Intended use
Installation instructions – Pre-setting installation

Annex B7

Installation instructions – Pre-setting installation (continuation)

Injection		
3		Check minimum shelf-life on VMZ cartridge. Never use when expired. Remove cap from VMZ cartridge. Screw static mixer on cartridge. When using a new cartridge always use a new Mixer Nozzle. Never use cartridge without static mixer and never use static mixer without helix inside.
4		Insert cartridge in Dispenser. Before injecting discard mortar (at least 2 full strokes or a line of 10 cm) until it shows a consistent grey colour. Never use this mortar.
5		Prior to injection check if static mixer reaches the bottom of the drill hole. If it does not reach the bottom, plug mixer extension onto static mixer in order to properly fill the drill hole. Fill hole with a sufficient quantity of injection mortar. Start from the bottom of the drill hole and work out to avoid trapping air pockets.
Insertion of anchor rod		
6		Mark the embedment depth on the anchor rod. Insert the anchor rod by hand, rotating slightly up within processing time. The anchor rod is properly set when excess mortar seeps from the hole. If the hole is not completely filled, pull out anchor rod, let mortar cure, drill out hole and start again from step 2.
7		Follow minimum curing time shown in Annex B4 as well as on cartridge label. During curing time anchor rod must not be moved or loaded.
8		Remove excess mortar after curing time.
9		<ol style="list-style-type: none"> 1. Fixture, washer and nut (without centring ring) can be mounted. 2. Apply installation torque T_{inst} according to Table B1 by using torque wrench. 3. Screw on locknut hand-tight then tighten $\frac{1}{4}$ to $\frac{1}{2}$ turn using a screw wrench.
10		Annular gap between anchor rod and fixture must be filled with injection mortar through the bore of the conical washer using the adapter plugged onto the static mixer. The annular gap is properly filled when excess mortar seeps out.

Injection System VMZ dynamic

Intended use
Installation instructions – Pre-setting installation (continuation)

Annex B8

Installation instructions – Installation with clearance between concrete and anchor plate (if the fastener is only loaded in axial direction)

Work steps 1 - 5 as illustrated in Annex B5 and B6

Insertion of anchor rod

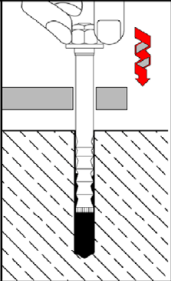
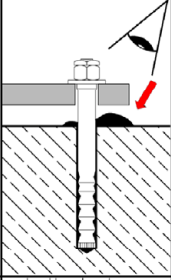
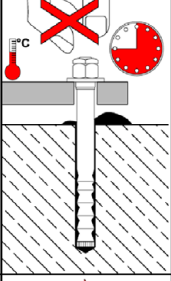
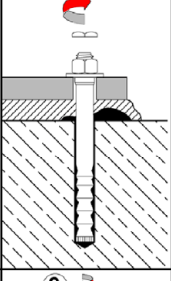
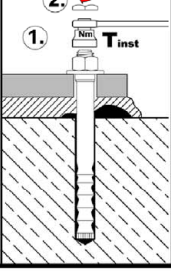
6		Inserting the pre-assembled anchor within processing time by hand, rotating slightly until the conical washer lies against the fixture.
7		Check for excess mortar seeping out of the hole. If the hole is not completely filled, pull out anchor rod, let mortar cure, drill out hole and start again from step 2. The annular gap in the fixture does not have to be filled.
8		Follow minimum curing time shown in Annex B4 as well as on cartridge label. During curing time anchor rod must not be moved or loaded.
9		Remove locknut after curing time and backfilling of anchor plate.
10		1. Apply installation torque T_{inst} according to Annex B2 (Table B1) by using torque wrench. 2. Screw on locknut hand-tight then tighten $\frac{1}{4}$ to $\frac{1}{2}$ turn using a screw wrench.

Injection System VMZ dynamic

Intended use

Installation instructions – Installation with clearance between concrete and anchor plate

Annex B9

Table C1: Characteristic values of the fatigue resistance under tension load after n load cycles without static actions ($F_{Elod} = 0$) design method I according to TR 061

Anchor size / version		100 M12	100 M12 A4 100 M12 HCR	125 M16	125 M16 A4 125 M16 HCR	170 M20
Steel failure						
Characteristic resistance without static actions	[kN]	$\Delta N_{Rk,s,0,n}$				
Number of load cycles n	1	53,9	53,9	83,4	83,4	112,1
	$\leq 10^3$	48,3	52,6	78,8	72,5	92,7
	$\leq 3 \cdot 10^3$	45,9	50,9	77,1	68,2	89,9
	$\leq 10^4$	41,4	47,6	73,1	62,4	83,4
	$\leq 3 \cdot 10^4$	35,9	42,8	66,3	56,7	73,8
	$\leq 10^5$	29,1	36,3	55,8	50,5	60,9
	$\leq 3 \cdot 10^5$	24,2	30,1	45,5	45,7	50,7
	$\leq 10^6$	21,1	24,9	37,4	41,8	44,9
	$> 10^6$	20,1	21,2	34,0	37,3	43,5
Partial factor	$\gamma_{Ms,fat,n}$ [-]	according to TR 061, Eq. (3)				
Exponent for combined loading	α_{sn} [-]	1,5	1,2	1,5	1,5	1,5
Pull-out						
Characteristic resistance without static actions	$\Delta N_{Rk,p,0,n}$ [kN]	$(\Delta N_{Rk,s,0,n} / \gamma_{Ms,fat,n}) \cdot \gamma_{Mp,fat}$				
Partial factor	$\gamma_{Mp,fat}$ [-]	1,5				
Concrete failure						
Characteristic resistance without static actions	$\Delta N_{Rk,c,0,n}$ [kN]	$\eta_{k,c,N,fat,n} \cdot N_{Rk,c}^{1)}$				
	$\Delta N_{Rk,sp,0,n}$ [kN]	$\eta_{k,c,N,fat,n} \cdot N_{Rk,sp}^{1)}$				
Reduction factor	[-]	$\eta_{k,c,N,fat,n}$				
Number of load cycles n	1	1,0				
	$\leq 10^3$	0,932				
	$\leq 3 \cdot 10^3$	0,893				
	$\leq 10^4$	0,841				
	$\leq 3 \cdot 10^4$	0,794				
	$\leq 10^5$	0,750				
	$\leq 3 \cdot 10^5$	0,722				
	$\leq 10^6$	0,704				
	$> 10^6$	0,693				
Effective anchorage depth	h_{ef} [mm]	100		125		170
Partial factor	$\gamma_{Mc,fat}$ [-]	1,5				
Exponent for combined loading	α_c [-]	1,5				
Load-transfer factor for fastener groups	ψ_{FN} [-]	0,79				

¹⁾ see table C4

Injection System VMZ dynamic

Performance

Characteristic fatigue resistance under **tension load, design method I** according to TR 061

Annex C1

Table C2: Characteristic values of the fatigue resistance under shear load after n load cycles without static actions ($F_{E lod} = 0$) design method I according to TR 061

Anchor size / version		100 M12	100 M12 A4 100 M12 HCR	125 M16	125 M16 A4 125 M16 HCR	170 M20
Steel failure						
Characteristic resistance without static actions	[kN]	$\Delta V_{Rk,s,0,n}$				
Number of load cycles n	1	34,0		63,0	149,0	
	$\leq 10^3$	27,6	31,3	54,0	113,5	
	$\leq 3 \cdot 10^3$	23,8	28,3	47,2	91,6	
	$\leq 10^4$	18,6	23,5	36,5	65,0	
	$\leq 3 \cdot 10^4$	14,1	18,1	26,2	43,9	
	$\leq 10^5$	10,5	12,8	18,4	29,0	
	$\leq 3 \cdot 10^5$	8,9	9,8	15,6	23,2	
	$\leq 10^6$	8,2	8,5	15,0	21,3	
	$> 10^6$	8,2		15,0	21,1	
Partial factor	$\gamma_{Ms,fat,n}$ [-]	according TR 061, Eq. (3)				
Exponent for combined loading	α_{sn} [-]	1,5	1,2	1,5	1,5	1,5
Concrete failure						
Characteristic resistance without static actions	$\Delta V_{Rk,cp,0,n}$ [kN]	$\eta_{k,c,V,fat,n} \cdot V_{Rk,cp}^{1)}$				
	$\Delta V_{Rk,c,0,n}$ [kN]	$\eta_{k,c,V,fat,n} \cdot V_{Rk,c}^{1)}$				
Reduction factor	[-]	$\eta_{k,c,N,fat,n}$				
Number of load cycles n	1	1,0				
	$\leq 10^3$	0,799				
	$\leq 3 \cdot 10^3$	0,760				
	$\leq 10^4$	0,725				
	$\leq 3 \cdot 10^4$	0,700				
	$\leq 10^5$	0,680				
	$\leq 3 \cdot 10^5$	0,668				
	$\leq 10^6$	0,660				
	$> 10^6$	0,652				
Effective anchor length	l_f [mm]	100		125		170
Outside diameter	d_{nom} [mm]	14		18		24
Partial factor	$\gamma_{Mc,fat}$ [-]	1,5				
Exponent for combined loading	α_c [-]	1,5				
Load-transfer factor for fastener groups	ψ_{FV} [-]	0,81				

¹⁾ see table C4

Injection System VMZ dynamic

Performance

Characteristic fatigue resistance under **shear load** for **design method I** according to **TR 061**

Annex C2

Table C3: Characteristic fatigue limit resistance for design according to EN 1992-4:2018 and design method II according to TR 061

Anchor size / version			100 M12	100 M12 A4 100 M12 HCR	125 M16	125 M16 A4 125 M16 HCR	170 M20
Tension load							
Steel failure							
Characteristic fatigue resistance	$\Delta N_{Rk,s,0,\infty}$	[kN]	20,1	21,2	34,0	37,3	43,5
Partial factor	$\gamma_{Ms,fat}$	[-]	1,35				
Load-transfer factor for fastener groups	ψ_{FN}	[-]	0,79				
Pull-out							
Characteristic fatigue resistance	$\Delta N_{Rk,p,0,\infty}$	[kN]	$(\Delta N_{Rk,s,0,\infty} / \gamma_{Ms,N,fat}) \cdot \gamma_{Mp,fat}$				
Partial factor	$\gamma_{Mp,fat}$	[-]	1,5				
Concrete failure							
Characteristic fatigue resistance	$\Delta N_{Rk,c,0,\infty}$	[kN]	0,693 $N_{Rk,c}$ ¹⁾				
	$\Delta N_{Rk,sp,0,\infty}$	[kN]	0,693 $N_{Rk,sp}$ ¹⁾				
Effective anchorage depth	h_{ef}	[mm]	100	125		170	
Partial factor	$\gamma_{Mc,fat}$	[-]	1,5				
Shear load							
Steel failure without lever arm							
Characteristic fatigue resistance	$\Delta V_{Rk,s,0,\infty}$	[kN]	8,2	15,0		21,1	
Partial factor	$\gamma_{Ms,fat}$	[-]	1,35				
Load-transfer factor for fastener groups	ψ_{FV}	[-]	0,81				
Concrete pry-out failure							
Characteristic fatigue resistance	$\Delta V_{Rk,cp,0,\infty}$	[kN]	0,652 $V_{Rk,cp}$ ¹⁾				
Partial factor	$\gamma_{Mc,fat}$	[-]	1,5				
Concrete edge failure							
Characteristic fatigue resistance	$\Delta V_{Rk,c,0,\infty}$	[kN]	0,652 $V_{Rk,c}$ ¹⁾				
Effective length of anchor	l_r	[mm]	100	125		170	
Outside diameter of anchor	d_{nom}	[mm]	14	18		24	
Partial factor	$\gamma_{Mc,fat}$	[-]	1,5				
Exponents for combined loading	α_s	[-]	1,5	1,2	1,5		1,5
	α_{sn}	[-]					
	α_c	[-]	1,5				
Injection System VMZ dynamic							Annex C3
Performance Characteristic fatigue limit resistance for design according to EN 1992-4 and design method II according to TR 061							

Table C4: Characteristic values under tension load for static and quasi-static or seismic action

Anchor size / version			100 M12 100 M12 A4 100 M12 HCR	125 M16 125 M16 A4 125 M16 HCR	170 M20	
Steel failure						
Characteristic resistance	$N_{RK,s}$ $N_{RK,s,C1}$ $N_{RK,s,C2}$	[kN]	57	111	188	
Partial factor	γ_{Ms}	[-]	1,5			
Pull-out failure						
Characteristic resistance (C20/25)	uncracked concrete	$N_{RK,p}$	[kN]	49,2	68,8	109
	cracked concrete	$N_{RK,p}$	[kN]	34,4	48,1	76,3
	seismic C1	$N_{RK,p,C1}$	[kN]	36,0	43,7	88,2
	seismic C2	$N_{RK,p,C2}$	[kN]	17,6	26,1	59,7
Concrete cone failure						
Characteristic edge distance	$c_{cr,N}$	[mm]	$1,5 \cdot h_{ef}$			
Factor k1	uncracked concrete	$k_{ucr,N}$	[-]	11,0		
	cracked concrete	$k_{cr,N}$	[-]	7,7		
Effective anchorage depth	h_{ef}	[mm]	100	125	170	
Splitting						
For each proof of splitting failure, $N_{RK,sp}$ shall be calculated according to EN 1992-4:2018, equation (7.23). The higher value for $N_{RK,sp}$ of case 1 and case 2 may be applied for the design.						
Standard thickness of concrete		$h_{min,1} \geq$	[mm]	200	250	340
Case 1	Characteristic resistance (C20/25)	$N^0_{RK,sp}$	[kN]	40	50	109
	Characteristic edge distance	$c_{cr,sp}$	[mm]	$1,5 \cdot h_{ef}$		
Case 2	Characteristic resistance	$N^0_{RK,sp}$	[kN]	min [$N_{RK,p}$; $N^0_{RK,c}$]		
	Characteristic edge distance	$c_{cr,sp}$	[mm]	$2 \cdot h_{ef}$	$2 \cdot h_{ef}$	$1,5 \cdot h_{ef}$
Minimum thickness of concrete		$h_{min,2} \geq$	[mm]	130	160	220
Case 1	Characteristic resistance (C20/25)	$N^0_{RK,sp}$	[kN]	30	40	75
	Characteristic edge distance	$c_{cr,sp}$	[mm]	$1,5 \cdot h_{ef}$		
Case 2	Characteristic resistance	$N^0_{RK,sp}$	[kN]	min [$N_{RK,p}$; $N^0_{RK,c}$]		
	Characteristic edge distance	$c_{cr,sp}$	[mm]	$3 \cdot h_{ef}$	$3 \cdot h_{ef}$	$2,6 \cdot h_{ef}$
Increasing factor for $N_{RK,p}$ and $N^0_{RK,sp}$ (case 1)		ψ_c	[-]	$\left(\frac{f_{ck}}{20}\right)^{0,5}$		
Installation factor		γ_{inst}	[-]	1,0		

Injection System VMZ dynamic

Performance

Characteristic values for tension load under static and quasi static or seismic action

Annex C4

Table C5: Characteristic values under shear load for static and quasi-static or seismic action

Anchor size / version			100 M12 100 M12 A4 100 M12 HCR	125 M16 125 M16 A4 125 M16 HCR	170 M20
Steel failure without lever arm					
Characteristic resistance	$V_{Rk,s}^0$	[kN]	34	63	149
	$V_{Rk,s,C1}^0$	[kN]	27,2	39,1	82,3
	$V_{Rk,s,C2}^0$	[kN]	27,2	50,4	108,8
Partial factor	γ_{Ms}	[-]	1,25		
Ductility factor	k_7	[-]	1,0		
Steel failure with lever arm					
Characteristic bending resistance	$M_{Rk,s}^0$	[Nm]	105	266	519
Partial factor	γ_{Ms}	[-]	1,25		
Concrete pry-out failure					
Pry-out factor	k_8	[-]	2,0		
Concrete edge failure					
Effective length of anchor in shear load	l_f	[mm]	100	125	170
Diameter of anchor	d_{nom}	[mm]	14	18	24
Installation factor	γ_{inst}	[-]	1,0		
Factor for anchorages with filled annular gap	α_{gap}	[-]	1,0		

Injection System VMZ dynamic

Performance
Characteristic values under **shear load** for **static and quasi-static** or **seismic action**

Annex C5

Table C6: Displacements under tension load for static and quasi-static or seismic action

Anchor size / version			100 M12 100 M12 A4 100 M12 HCR	125 M16 125 M16 A4 125 M16 HCR	170 M20
Tension load in cracked concrete	N	[kN]	17,1	24	38
Displacements	δ_{N0}	[mm]	0,6	0,7	0,8
	$\delta_{N\infty}$	[mm]	1,3	1,3	1,3
Tension load in uncracked concrete	N	[kN]	24	33	53,3
Displacements	δ_{N0}	[mm]	0,4	0,6	0,6
	$\delta_{N\infty}$	[mm]	1,3	1,3	1,3
Displacements under seismic tension loads C2					
Displacements	$\delta_{N,C2(DLS)}$	[mm]	1,1	1,5	1,9
	$\delta_{N,C2(ULS)}$	[mm]	3,0	4,4	4,5

Table C7: Displacements under shear load for static and quasi-static or seismic action

Anchor size / version			100 M12 100 M12 A4 100 M12 HCR	125 M16 125 M16 A4 125 M16 HCR	170 M20
Shear load	V	[kN]	19,3	36	75
Displacements	δ_{V0}	[mm]	3,3	3,8	4,3
	$\delta_{V\infty}$	[mm]	5,0	5,7	6,5
Displacements under seismic shear loads C2					
Displacements	$\delta_{V,C2(DLS)}$	[mm]	2,5	2,9	3,5
	$\delta_{V,C2(ULS)}$	[mm]	5,1	6,8	9,3

Injection System VMZ dynamic

Performance
Displacements under **static and quasi-static** or **seismic action**

Annex C6