



...eine starke Verbindung

## DECLARAȚIA DE PERFORMANȚĂ

DoP Nr.: **MKT-350** - ro

- ❖ **Cod unic de identificare al produsului-tip:** **Sistemul de injecție VMZ dinamic**
- ❖ **Utilizare (utilizări) preconizată (preconizate):** Elementele de fixare consolidate din beton, sub sarcină ciclică legată de oboseală,, a se vedea anexa / Annex B
- ❖ **Fabricant:** MKT Metall-Kunststoff-Technik GmbH & Co.KG  
Auf dem Immel 2  
67685 Weilerbach
- ❖ **Sistemul (sistemele) de evaluare și de verificare a constanței performanței:** 1
- ❖ **Documentul de evaluare european:** **EAD 330250-00-0601**  
Evaluarea tehnică europeană: **ETA-17/0194, 31.05.2018**  
Organismul de evaluare tehnică: DIBt, Berlin  
Organism (organisme) notificat(e): NB 1343 – MPA, Darmstadt

❖ **Performanța (performanțe) declarată (declarate):**

Caracteristici esențiale (Metoda de evaluare A)	Performanță
<b>Rezistență mecanică și stabilitate (BWR1)</b>	
Rezistență obișnuită la sarcină ciclică	Anexa/Annex C1 + C2
Factorul de transfer al sarcinii pentru sarcini ciclice de tracțiune și transversală	Anexa/Annex C1 + C2

Performanța produsului identificat mai sus este în conformitate cu setul de performanțe declarate. Această declarație de performanță este eliberată în conformitate cu Regulamentul (UE) nr. 305/2011, pe răspunderea exclusivă a fabricantului identificat mai sus.

Semnată pentru și în numele fabricantului de către:

  
**Stefan Weustenhagen**

(Director general)

**Weilerbach, 31.05.2018**

p.p. 

**Dipl.-Ing. Detlef Bigalke**

(Șef de dezvoltare a produselor)



Originalul acestei declarații de performanță a fost scris în limba germană. În cazul abaterilor în traducere, versiunea germană este validă.

## Specifications of intended use

### Anchorage subject to:

- Fatigue cyclic loading

Note: Static and quasi-static action according to ETA-04/0092

### Base materials:

- Compacted reinforced or unreinforced normal weight concrete without fibers according to EN 206:2013
- Strength classes C20/25 to C50/60 according to EN 206:2013
- Cracked and uncracked concrete
- Temperature Range -40 °C to +80 °C:  
maximum short term temperature +80 °C and maximum long term temperature +50 °C

### Use conditions (Environmental conditions): according to ETA-04/0092

- Structures subject to dry internal conditions (VMZ dynamic zinc plated, A4 or HCR).
- Structures subject to external atmospheric exposure including industrial and marine environment or exposure to permanently damp internal conditions, if no particular aggressive conditions exist (VMZ dynamic A4 or HCR).
- Structures subject to external atmospheric exposure or exposure in permanently damp internal conditions or particular aggressive conditions ((VMZ dynamic HCR).

Note: Particular aggressive conditions are e.g. permanent, alternating immersion in seawater or the splash zone of seawater, chloride atmosphere of indoor swimming pools or atmosphere with extreme chemical pollution (e.g. in desulphurization plants or road tunnels where de-icing materials are used).

### Design:

- Anchorages are designed under the responsibility of an engineer experienced in anchorages and concrete work.
- Verifiable calculation notes and drawings are prepared taking account of the loads to be anchored. The position of the anchor is indicated on the design drawings (e.g. position of the anchor relative to reinforcement or to supports, etc.).
- Anchorages are designed according to
  - EOTA TR 061:2018 (Design method I and II) or
  - FprEN 1992-4:2016

### Installation:

- Anchor shall only be used as a complete fastening unit delivered in series. Components of the anchor must not be replaced.
- Anchor installation carried out by appropriately qualified personnel and under the supervision of the site manager.
- In case of aborted hole: new drilling at a distance of at least two times the depth of the aborted hole or at a smaller distance, if the aborted drill hole is filled with high strength mortar.
- The installation temperature of anchor components shall be at least +5 °C; during curing of the injection mortar the temperature of the concrete must not fall below 0 °C. Curing time must be observed prior to loading the anchor.
- Drilling by hammer drill bit or compressed air drill (use of vacuum drill bit is admissible)
- The filling of the annular gap can be omitted if it is ensured that the anchor is only loaded in axial direction.

## Injection System VMZ dynamic

Intended use  
Specifications

Annex B1

**Table B1: Installation parameters**

Anchor size / version		100 M12	100 M12 A4 100 M12 HCR	125 M16	125 M16 A4 125 M16 HCR	170 M20
Effective anchorage depth	$h_{ef} \geq$ [mm]	100		125		170
Nominal diameter of drill hole	$d_0 =$ [mm]	14		18		24
Depth of drill hole <sup>1)</sup>	$h_0 \geq$ [mm]	105		133		180
Diameter of cleaning brush	$D \geq$ [mm]	15,0		19,0		25,0
Installation torque	$T_{inst} =$ [Nm]	30		50		80
Diameter of clearance hole in the fixture	$d_f =$ [mm]	15		19		25
Fixture thickness <sup>2)</sup>	$t_{fix,min} \geq$ [mm]	12		16		20
	$t_{fix,max} \leq$ [mm]	200				
Overstand	$h_p =$ [mm]	$31 + t_{fix}$	$24 + t_{fix}$	$39 + t_{fix}$	$30 + t_{fix}$	$48 + t_{fix}$

<sup>1)</sup> If the present fixture thickness is lower than the maximum fixture thickness of the anchor, the depth of drill hole should be increased accordingly.

<sup>2)</sup>  $t_{fix,min}$  may be replaced by  $t_{fix,min,red}$ , if a reduced fatigue resistance  $\Delta V_{R,red}$  in transverse direction is considered:

$$t_{fix,min,red} = (0,5 + 0,5 \cdot \Delta V_{R,red} / \Delta V_R) \cdot t_{fix,min}$$

where  $\Delta V_R = \Delta V_{RK,s,0,n}$  - Design method I (Table C1)

where  $\Delta V_R = \Delta V_{RK,s,\infty}$  - Design method II (Table C2)

Pre-setting installation

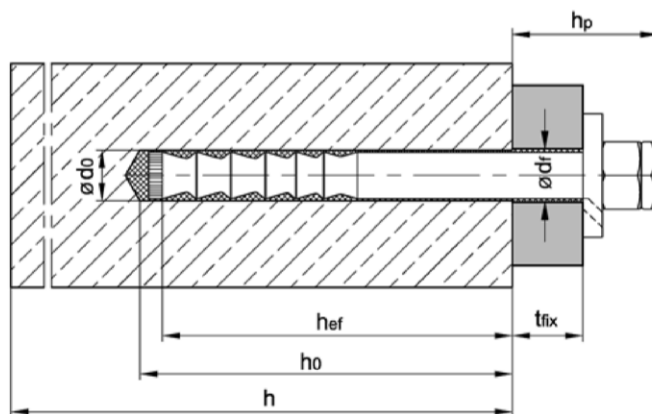

Through-setting installation

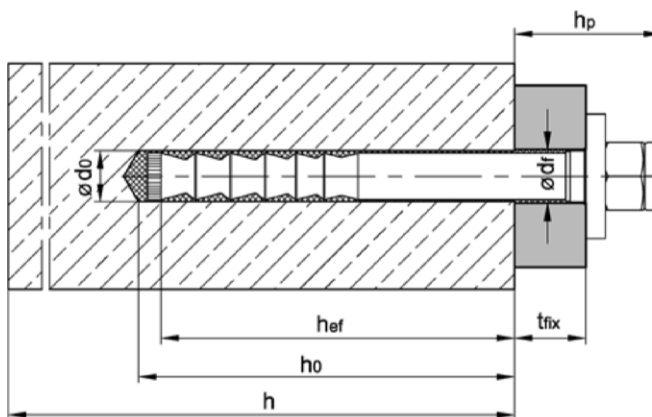

**Injection System VMZ dynamic**

**Intended use**  
Installation parameters

**Annex B2**

**Table B2: Minimum thickness of concrete and minimum spacing and edge distance**

Anchor size			100 M12	125 M16	170 M20
Minimum thickness of concrete member	$h_{min}$	[mm]	130	170 160 <sup>1)</sup>	230 220 <sup>1)</sup>
<b>Cracked concrete</b>					
Minimum spacing	$s_{min}$	[mm]	50	60	80
Minimum edge distance	$c_{min}$	[mm]	70	80	110
<b>Uncracked concrete</b>					
Minimum spacing	$s_{min}$	[mm]	80	60	80
Minimum edge distance	$c_{min}$	[mm]	75	80	110

<sup>1)</sup> The remote face of the concrete member shall be inspected to ensure there has been no break-through by drilling. In case of break-through the ground of the drill hole shall be closed with high strength mortar. The full bonded length  $h_{ef}$  shall be achieved and any potential loss of injection mortar shall be compensated.

**Table B3: Processing time and curing time until the application of the load, VMZ**

Temperature [°C] in the drill hole	Maximum processing time	Minimum curing time	
		dry concrete	wet concrete
+ 40 °C	1,4 min	15 min	30 min
+ 35 °C to + 39 °C	1,4 min	20 min	40 min
+ 30 °C to + 34 °C	2 min	25 min	50 min
+ 20 °C to + 29 °C	4 min	45 min	1:30 h
+ 10 °C to + 19 °C	6 min	1:20 h	2:40 h
+ 5 °C to + 9 °C	12 min	2:00 h	4:00 h
0 °C to + 4 °C	20 min	3:00 h	6:00 h

**Table B4: Processing time and curing time until the application of the load, VMZ express**

Temperature [°C] in the drill hole	Maximum processing time	Minimum curing time	
		dry concrete	wet concrete
+ 30 °C	1 min	10 min	20 min
+ 20 °C to + 29 °C	1 min	20 min	40 min
+ 10 °C to + 19 °C	3 min	40 min	80 min
+ 5 °C to + 9 °C	6 min	1:00 h	2:00 h
0 °C to + 4 °C	10 min	2:00 h	4:00 h

**Injection System VMZ dynamic****Intended use**

Minimum thickness of concrete, spacing and edge distances, processing and curing time

**Annex B3**

# Installation instructions – Through-setting installation

Hole drilling		
1		<p>Drill hole perpendicular to concrete surface with hammer drill, vacuum drill or compressed air drill.</p> <p><b>Drill hole must be cleaned directly prior to installation of the anchor.</b></p>
Cleaning		
2a		<p><b>VMZ M12 - M16:</b> Blow out drill hole from the bottom using Blow-out Pump VM-AP at least two times.</p>
2b		<p><b>VMZ M20:</b> Connect Air Blower VM-ABP to compressed air (min. 6 bar, oil-free). Open air valve and blow out drill hole along the entire depth with back and forth motion at least two times.</p>
3		<p>Check diameter of Cleaning Brush RB. If brush can be pushed into the drill hole without any resistance, it must be replaced. Chuck brush into drill machine. Turn on drill machine. Brush drill hole back and forth along the entire drill hole depth at least two times while rotated by drill machine.</p>
4a		<p><b>VMZ M12 - M16:</b> Blow out drill hole from the bottom using Blow-out Pump VM-AP at least two times.</p>
4b		<p><b>VMZ M20:</b> Connect Air Blower VM-ABP to compressed air (min. 6 bar, oil-free). Open air valve and blow out drill hole along the entire depth with back and forth motion at least two times.</p>
Injection		
5		<p>Check minimum shelf-life on VMZ cartridge. Never use when expired. Remove cap from VMZ cartridge. Screw Mixer Nozzle VM-X on cartridge. When using a new cartridge always use a new Mixer Nozzle. Never use cartridge without Mixer Nozzle and never use Mixer Nozzle without helix inside.</p>
6		<p>Insert cartridge in dispenser. Before injecting discard mortar (at least 2 full strokes or a line of 10 cm) until it shows a consistent grey colour. Never use this mortar.</p>
7		<p>Prior to injection, check if Mixer Nozzle VM-X reaches the bottom of the drill hole. If it does not reach the bottom, plug Mixer Extension VM-XE onto Mixer Nozzle, in order to properly fill the drill hole. Fill hole with a sufficient quantity of injection mortar. Start from the bottom of the drill hole and work out to avoid trapping air pockets.</p>

## Injection System VMZ dynamic

### Intended use

Installation instructions – Through-setting installation

**Annex B4**

## Installation instructions – Through-setting installation (continuation)

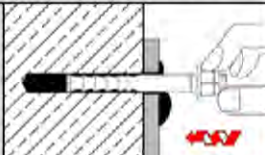
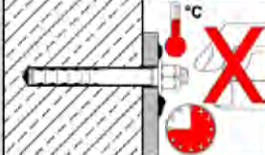
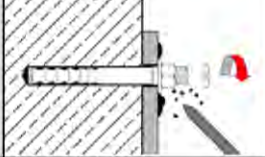
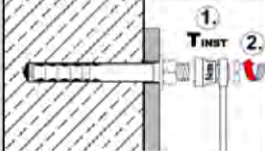
Insertion of anchor rod		
8		<p>Insert the pre-assembled anchor within processing time by hand, rotating slightly up to the full embedment depth, until the conical washer lies against the fixture. The anchor rod is properly set when the gap between anchor rod and fixture is completely filled.</p> <p>If the hole is not completely filled, pull out anchor rod, let mortar cure, drill out hole and start again from step 2.</p>
9		<p>Follow minimum curing time shown in Table B3 and Table B4 as well as on cartridge label. During curing time anchor rod must not be moved or loaded.</p>
10		<p>Remove excess mortar after curing time. Remove locknut.</p>
11		<ol style="list-style-type: none"> <li>1. Apply installation torque <math>T_{inst}</math> according to Table B1 by using torque wrench.</li> <li>2. Screw on locknut until hand tight then tighten <math>\frac{1}{4}</math> to <math>\frac{1}{2}</math> turn using a screw wrench.</li> </ol>

Injection System VMZ dynamic

### Intended use

Installation instructions – Through-setting installation (continuation)

Annex B5

# Installation instructions – Pre-setting installation

Hole drilling		
1		Drill perpendicular to concrete surface with hammer drill, vacuum drill or compressed air drill. <b>Drill hole must be cleaned directly prior to installation of the anchor.</b>
Cleaning		
2a		<b>VMZ M12 - M16:</b> Blow out drill hole from the bottom using Blow-out Pump VM-AP at least two times.
2b		<b>VMZ M20:</b> Connect Air Blower VM-ABP to compressed air (min. 6 bar, oil-free). Open air valve and blow out drill hole along the entire depth with back and forth motion at least two times.
3		Check diameter of Cleaning Brush RB. If brush can be pushed into the drill hole without any resistance, it must be replaced. Chuck brush into drill machine. Turn on drill machine. Brush drill hole back and forth along the entire drill hole depth at least two times while rotated by drill machine.
4a		<b>VMZ M12 - M16:</b> Blow out drill hole from the bottom using Blow-out Pump VM-AP at least two times.
4b		<b>VMZ M20:</b> Connect Air Blower VM-ABP to compressed air (min. 6 bar, oil-free). Open air valve and blow out drill hole along the entire depth with back and forth motion at least two times.
Injection		
5		Check minimum shelf-life on VMZ cartridge. Never use when expired. Remove cap from VMZ cartridge. Screw Mixer Nozzle VM-X on cartridge. When using a new cartridge always use a new Mixer Nozzle. Never use cartridge without Mixer Nozzle and never use Mixer Nozzle without helix inside.
6		Insert cartridge in Dispenser. Before injecting discard mortar (at least 2 full strokes or a line of 10 cm) until it shows a consistent grey colour. Never use this mortar.
7		Prior to injection check if Mixer Nozzle VM-X reaches the bottom of the drill hole. If it does not reach the bottom, plug Mixer Extension VM-XE onto Mixer Nozzle in order to properly fill the drill hole. Fill hole with a sufficient quantity of injection mortar. Start from the bottom of the drill hole and work out to avoid trapping air pockets.



## Injection System VMZ dynamic

### Intended use

Installation instructions – Pre-setting installation

**Annex B6**

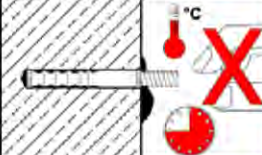
## Installation instructions – Pre-setting installation (continuation)

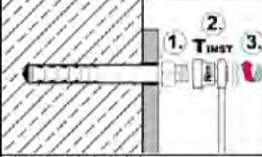
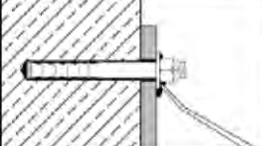
Insertion of anchor rod		
8		Mark the embedment depth on the anchor rod. Insert the anchor rod by hand, rotating slightly up within processing time. The anchor rod is properly set when excess mortar seeps from the hole. If the hole is not completely filled, pull out anchor rod, let mortar cure, drill out hole and start again from step 2.
9		Follow minimum curing time shown in Annex B3 (Table B3 and Table B4) as well as on cartridge label. During curing time anchor rod must not be moved or loaded.
10		Remove excess mortar after curing time.
11		<ol style="list-style-type: none"> <li>1. Fixture, washer and nut (without centring ring) can be mounted.</li> <li>2. Apply installation torque <math>T_{inst}</math> according to Annex B2 (Table B1) by using torque wrench.</li> <li>3. Screw on locknut until hand tight then tighten <math>\frac{1}{4}</math> to <math>\frac{1}{2}</math> turn using a screw wrench.</li> </ol>
12		Annular gap between anchor rod and fixture must be filled with injection mortar through the bore of the conical washer using the adapter plugged onto the static mixer. The annular gap is properly filled when excess mortar seeps out.

Injection System VMZ dynamic

Intended use

Installation instructions – Pre-setting installation (continuation)



Annex B7



## Installation instructions – Installation with clearance between concrete and anchor plate (only if the fastener is only loaded in axial direction)

Work steps 1 - 7 as illustrated in Annex B4

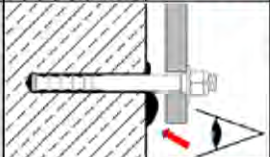
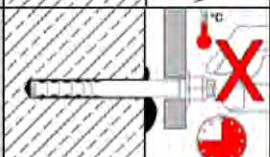
### Insertion of anchor rod

8		Inserting the pre-assembled anchor within processing time by hand, rotating slightly until the conical washer lies against the fixture.
9		Check, if excess mortar seeps from hole. If the hole is not completely filled, pull our anchor rod, let mortar cure, drill out hole and start again from step 2.  The annular gap in the fixture does not have to be filled.
10		Follow minimum curing time shown in Annex B3 (Table B3 and Table B4) as well as on cartridge label. During curing time anchor rod must not be moved or loaded.
11		Remove locknut after curing time has expired and backfilling of anchor plate.
12		1. Apply installation torque $T_{inst}$ according to Annex B2 (Table B1) by using torque wrench. 2. Screw on locknut until hand tight then $\frac{1}{4}$ to $\frac{1}{2}$ turn using a screw wrench.

**Injection System VMZ dynamic**

**Intended use**

Installation instructions – Installation with clearance between concrete and anchor plate

**Annex B8**

**Table C1: Characteristic values of the fatigue resistance after n load cycles without static actions ( $F_{Elod} = 0$ ) for design method I according to TR 061**

Anchor size / version	100 M12	100 M12 A4 100 M12 HCR	125 M16	125 M16 A4 125 M16 HCR	170 M20						
<b>Steel failure<sup>1)</sup></b>											
	n	$\Delta N_{Rk,s,0,n}$	$\Delta V_{Rk,s,0,n}$	$\Delta N_{Rk,s,0,n}$	$\Delta V_{Rk,s,0,n}$	$\Delta N_{Rk,s,0,n}$	$\Delta V_{Rk,s,0,n}$	$\Delta N_{Rk,s,0,n}$	$\Delta V_{Rk,s,0,n}$	$\Delta N_{Rk,s,0,n}$	$\Delta V_{Rk,s,0,n}$
Characteristic resistance without static actions [kN]	1	53,9	34,0	53,9	34,0	83,4	63,0	83,4	63,0	112,1	149,0
	$\leq 10^3$	48,3	27,6	52,6	31,3	78,8	54,0	72,5	54,0	92,7	113,5
	$\leq 3 \cdot 10^3$	45,9	23,8	50,9	28,3	77,1	47,2	68,2	47,2	89,9	91,6
	$\leq 10^4$	41,4	18,6	47,6	23,5	73,1	36,5	62,4	36,5	83,4	65,0
	$\leq 3 \cdot 10^4$	35,9	14,1	42,8	18,1	66,3	26,2	56,7	26,2	73,8	43,9
	$\leq 10^5$	29,1	10,5	36,3	12,8	55,8	18,4	50,5	18,4	60,9	29,0
	$\leq 3 \cdot 10^5$	24,2	8,9	30,1	9,8	45,5	15,6	45,7	15,6	50,7	23,2
	$\leq 10^6$	21,1	8,2	24,9	8,5	37,4	15,0	41,8	15,0	44,9	21,3
$\geq 10^6$	20,1	8,2	21,2	8,2	34,0	15,0	37,3	15,0	43,5	21,1	
Partial factor	$\gamma_{Ms,fat}$	Acc. to TR 061, Eq. (3)									
Exponent for combined loading	$\alpha_{sn}$	1,5	1,2	1,5	1,5	1,5	1,5	1,5	1,5	1,5	1,5
<b>Concrete failure</b> $\Delta N_{Rk,(c/sp/cb),0,n} = \eta_{k,c,N,fat,n} \cdot N_{Rk,(c/sp/cb)}$ and $\Delta V_{Rk,(c/cp),0,n} = \eta_{k,c,V,fat,n} \cdot V_{Rk,(c/cp)}$ <sup>2)</sup>											
	n	$\eta_{k,c,N,fat,n}$	$\eta_{k,c,V,fat,n}$	$\eta_{k,c,N,fat,n}$	$\eta_{k,c,V,fat,n}$	$\eta_{k,c,N,fat,n}$	$\eta_{k,c,V,fat,n}$	$\eta_{k,c,N,fat,n}$	$\eta_{k,c,V,fat,n}$	$\eta_{k,c,N,fat,n}$	$\eta_{k,c,V,fat,n}$
Reduction factor $\eta_{fat}$ for characteristic resistance	1	1,000	1,000	1,000	1,000	1,000	1,000	1,000	1,000	1,000	1,000
	$\leq 10^3$	0,932	0,799	0,932	0,799	0,932	0,799	0,932	0,799	0,932	0,799
	$\leq 3 \cdot 10^3$	0,893	0,760	0,893	0,760	0,893	0,760	0,893	0,760	0,893	0,760
	$\leq 10^4$	0,841	0,725	0,841	0,725	0,841	0,725	0,841	0,725	0,841	0,725
	$\leq 3 \cdot 10^4$	0,794	0,700	0,794	0,700	0,794	0,700	0,794	0,700	0,794	0,700
	$\leq 10^5$	0,750	0,680	0,750	0,680	0,750	0,680	0,750	0,680	0,750	0,680
	$\leq 3 \cdot 10^5$	0,722	0,668	0,722	0,668	0,722	0,668	0,722	0,668	0,722	0,668
	$\leq 10^6$	0,704	0,660	0,704	0,660	0,704	0,660	0,704	0,660	0,704	0,660
$\geq 10^6$	0,693	0,652	0,693	0,652	0,693	0,652	0,693	0,652	0,693	0,652	
Partial factor	$\gamma_{Mc,fat}$	1,5									
Exponent for combined loading	$\alpha_c$	1,5									
Load-transfer factor for fastener groups	$\psi_{FN}$	0,79									
	$\psi_{FV}$	0,81									

<sup>1)</sup> The failure in cracked concrete due to combined pull-out /concrete cone failure  $\Delta N_{Rk,p,0,n}$  in the low-cyclic loading range has been taken into account;

<sup>2)</sup>  $N_{Rk,c}$ ,  $N_{Rk,sp}$ ,  $N_{Rk,cb}$ ,  $V_{Rk,c}$  and  $V_{Rk,cp}$  – Characteristic values of resistance to concrete failure under static or quasi-static actions according to ETA-04/0092

**Injection System VMZ dynamic**

**Performance**

Characteristic fatigue resistance for design method I according to TR 061

**Annex C1**

**Table C2: Characteristic fatigue limit resistance for design according to FprEN 1992-4 and design method II according to TR 061**

Anchor size / version			100 M12	100 M12 A4 100 M12 HCR	125 M16	125 M16 A4 125 M16 HCR	170 M20
<b>Tension load</b>							
<b>Steel failure</b>							
Characteristic tension resistance	$\Delta N_{Rk,s,0,\infty}$ [kN]		20	21,2	34	37	43
Partial factor	$\gamma_{Ms,N,fat}$	-	1,35				
Exponent for combined loading	$\alpha_s$	-	1,5	1,2	1,5		
<b>Concrete failure</b>							
Characteristic tension resistance	$\Delta N_{Rk,c,0,\infty}$ [kN]		0,693 $N_{Rk,c}$ <sup>1)</sup>				
	$\Delta N_{Rk,sp,0,\infty}$ [kN]		0,693 $N_{Rk,sp}$ <sup>1)</sup>				
	$\Delta N_{Rk,cb,0,\infty}$ [kN]		0,693 $N_{Rk,cb}$ <sup>1)</sup>				
Effective anchorage depth	$h_{ef}$ [mm]		100		125		170
Partial factor	$\gamma_{Mc,fat}$	-	1,5				
Exponent for combined loading	$\alpha_c$	-	1,5				
Load-transfer factor for fastener groups	$\Psi_{F,N}$	-	0,79				
<b>Shear load</b>							
<b>Steel failure without lever arm</b>							
Characteristic shear resistance	$\Delta V_{Rk,s,0,\infty}$ [kN]		8,2		15		21
Partial factor	$\gamma_{Ms,V,fat}$	-	1,35				
Exponent for combined loading	$\alpha_s$	-	1,5	1,2	1,5		
<b>Concrete pry-out failure</b>							
Characteristic shear resistance	$\Delta V_{Rk,cp,0,\infty}$ [kN]		0,652 $V_{Rk,cp}$ <sup>1)</sup>				
Partial factor	$\gamma_{Mc,fat}$	-	1,5				
<b>Concrete edge failure</b>							
Characteristic shear resistance	$\Delta V_{Rk,c,0,\infty}$ [kN]		0,652 $V_{Rk,c}$ <sup>1)</sup>				
Effective length of anchor	$l_f$ [mm]		100		125		170
Diameter of anchor	$d_{nom}$ [mm]		14		18		24
Partial factor	$\gamma_{Mc,fat}$	-	1,5				
Exponent for combined loading	$\alpha_c$	-	1,5				
Load-transfer factor for fastener groups	$\Psi_{F,V}$	-	0,81				

<sup>1)</sup>  $N_{Rk,c}$ ,  $N_{Rk,sp}$ ,  $N_{Rk,cb}$ ,  $V_{Rk,c}$  and  $V_{Rk,cp}$  – Characteristic values of resistance to concrete failure under static or quasi-static actions according to ETA-04/0092

**Injection System VMZ dynamic**

**Performance**

Characteristic fatigue limit resistance for design according to FprEN 1992-4 and design method II according to TR 061

**Annex C2**