

Approval body for construction products
and types of construction

Bautechnisches Prüfamt

An institution established by the Federal and
Laender Governments



European Technical Assessment

ETA-11/0415
of 1 June 2021

English translation prepared by DIBt - Original version in German language

General Part

Technical Assessment Body issuing the
European Technical Assessment:

Deutsches Institut für Bautechnik

Trade name of the construction product

Injection System VMU plus for concrete

Product family
to which the construction product belongs

Bonded fastener for use in concrete

Manufacturer

MKT
Metall-Kunststoff-Technik GmbH & Co. KG
Auf dem Immel 2
67685 Weilerbach
DEUTSCHLAND

Manufacturing plant

Werk 1, D
Werk 2, D

This European Technical Assessment
contains

30 pages including 3 annexes which form an integral part
of this assessment

This European Technical Assessment is
issued in accordance with Regulation (EU)
No 305/2011, on the basis of

EAD 330499-01-0601, Edition 04/2020

This version replaces

ETA-11/0415 issued on 8 December 2017

The European Technical Assessment is issued by the Technical Assessment Body in its official language. Translations of this European Technical Assessment in other languages shall fully correspond to the original issued document and shall be identified as such.

Communication of this European Technical Assessment, including transmission by electronic means, shall be in full. However, partial reproduction may only be made with the written consent of the issuing Technical Assessment Body. Any partial reproduction shall be identified as such.

This European Technical Assessment may be withdrawn by the issuing Technical Assessment Body, in particular pursuant to information by the Commission in accordance with Article 25(3) of Regulation (EU) No 305/2011.

Specific Part

1 Technical description of the product

The "Injection system VMU plus for concrete" is a bonded anchor consisting of a cartridge with injection mortar VMU plus or VMU plus Polar and a steel element. The steel element consists of a commercial threaded rod with washer and hexagon nut in the range of M8 to M30 or reinforcing bar in the range of Ø 8 to Ø 32 mm or an internal threaded anchor rod VMU-IG-M6 to VMU-IG-M20.

The steel element is placed into a drilled hole filled with injection mortar and is anchored via the bond between metal part, injection mortar and concrete.

The product description is given in Annex A.

2 Specification of the intended use in accordance with the applicable European Assessment Document

The performances given in Section 3 are only valid if the anchor is used in compliance with the specifications and conditions given in Annex B.

The verifications and assessment methods on which this European Technical Assessment is based lead to the assumption of a working life of the anchor of at least 50 years. The indications given on the working life cannot be interpreted as a guarantee given by the producer, but are to be regarded only as a means for choosing the right products in relation to the expected economically reasonable working life of the works.

3 Performance of the product and references to the methods used for its assessment

3.1 Mechanical resistance and stability (BWR 1)

Essential characteristic	Performance
Characteristic resistance to tension load (static and quasi-static loading)	See Annex B 2, C 1, C 3, C 4, C 7 and C 9
Characteristic resistance to shear load (static and quasi-static loading)	See Annex C 2, C 5, C 8, C 10
Displacements (static and quasi-static loading)	See Annex C 12 and C 13
Characteristic resistance and displacements for seismic performance categories C1	See Annex C 6 and C 11
Characteristic resistance and displacements for seismic performance categories C2	No performance assessed

3.2 Hygiene, health and the environment (BWR 3)

Essential characteristic	Performance
Content, emission and/or release of dangerous substances	No performance assessed

English translation prepared by DIBt

4 Assessment and verification of constancy of performance (AVCP) system applied, with reference to its legal base

In accordance with the European Assessment Document EAD 330499-01-0601 the applicable European legal act is: [96/582/EC].

The system to be applied is: 1

5 Technical details necessary for the implementation of the AVCP system, as provided for in the applicable European Assessment Document

Technical details necessary for the implementation of the AVCP system are laid down in the control plan deposited at Deutsches Institut für Bautechnik.

Issued in Berlin on 1 June 2021 by Deutsches Institut für Bautechnik

Dipl.-Ing. Beatrix Wittstock
Head of Section

beglaubigt:
Baderschneider

Installation threaded rod M8 to M30

Pre-setting or through setting installation (optional with filled annular gap)

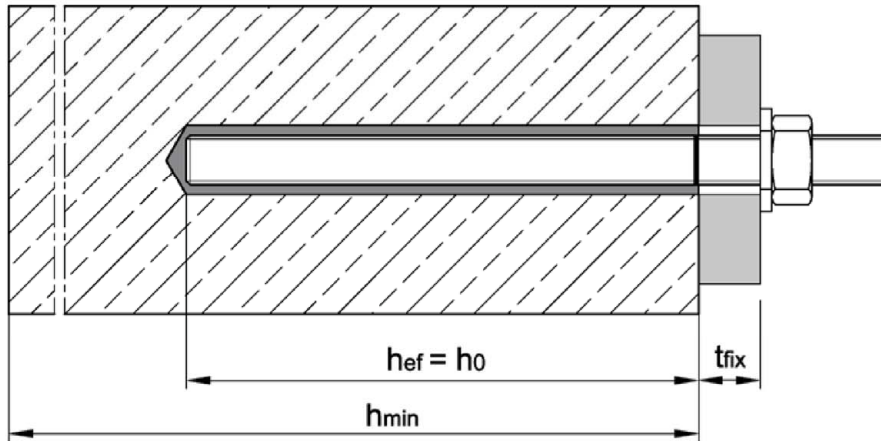

Installation internally threaded anchor rod VMU-IG-M6 to VMU-IG-M20

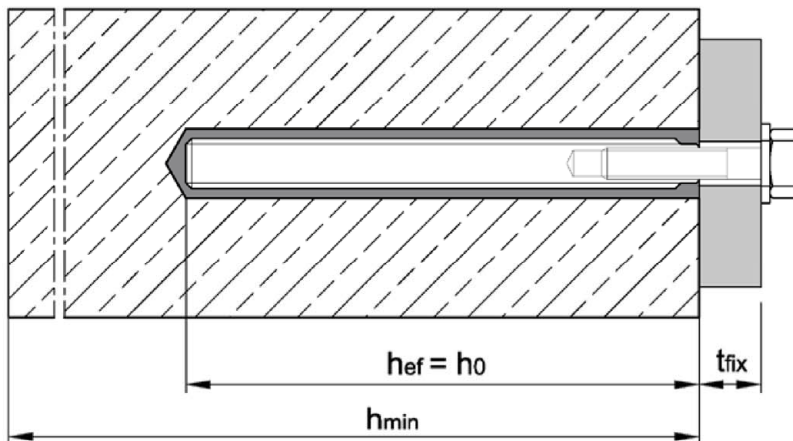

Installation reinforcing bar $\varnothing 8$ to $\varnothing 32$

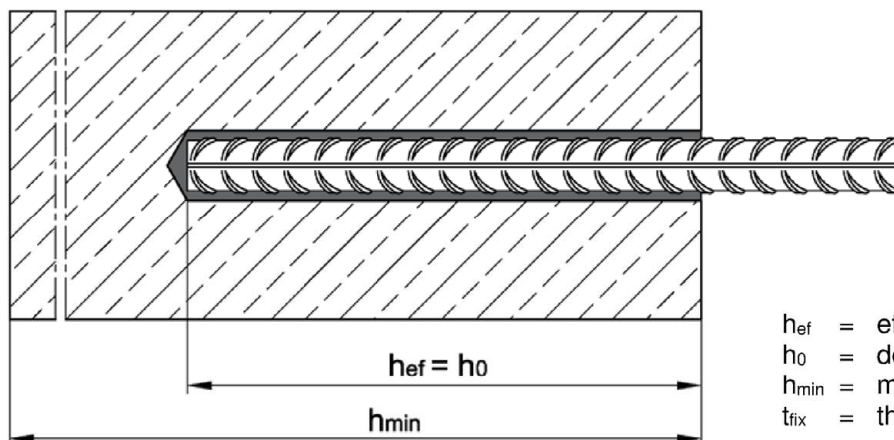

h_{ef} = effective anchorage depth
 h_0 = depth of drill hole
 h_{min} = minimum thickness of member
 t_{fix} = thickness of fixture

Injection system VMU plus for concrete

Product description
Installation situation

Annex A1

Cartridge VMU plus or VMU plus Polar

Coaxial cartridge

150 ml,
280 ml,
300 ml bis 333 ml
380 ml bis 420 ml



Side-by-side cartridge

235 ml,
345 ml bis 360 ml
825 ml

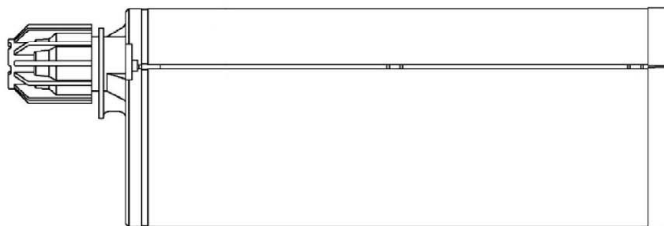

Foil tube cartridge

165 ml
300 ml



Cartridge imprint:

VMU plus or VMU plus Polar,
processing notes, charge-code, shelf life, hazard-code, storage temperature, curing- and processing time
(depending on the temperature), with as well as without travel scale

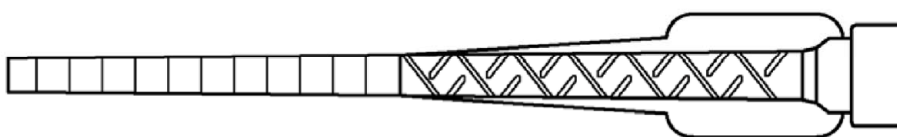

Static mixer

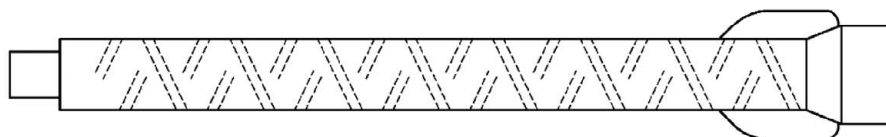

Injection system VMU plus for concrete

Product description

Cartridges and attachments

Annex A2

Threaded rod

Threaded rod VMU-A, V-A with washer and hexagon nut
M8, M10, M12, M16, M20, M24, M27, M30 (zinc plated, A4, HCR)

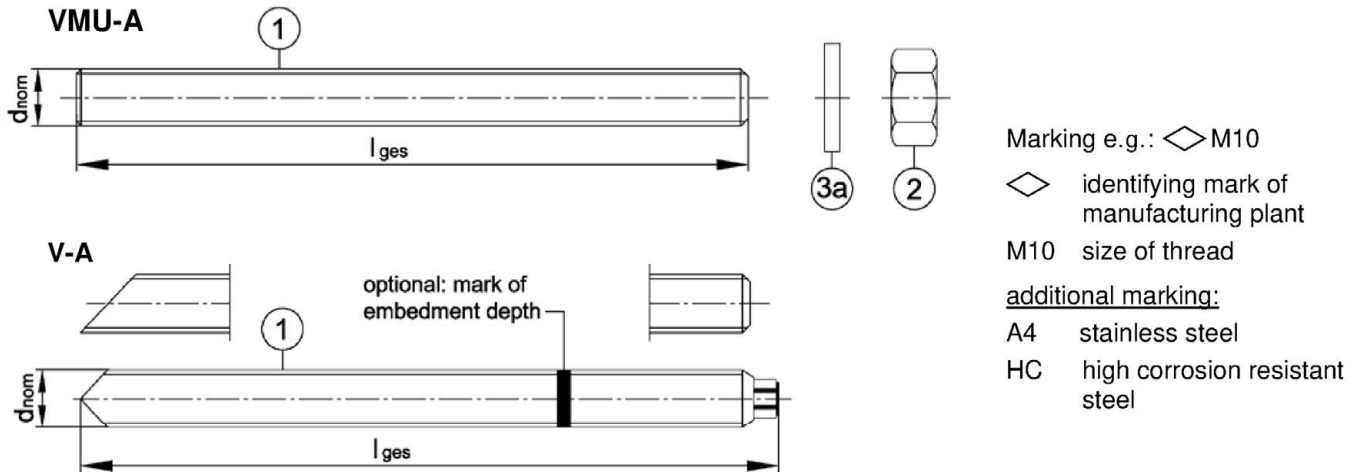

Threaded rod VM-A (material sold by the metre, to be cut at the required length)
M8, M10, M12, M16, M20, M24, M27, M30 (zinc plated, A2, A4, HCR)

Commercial standard threaded rod with:

M8, M10, M12, M16, M20, M24, M27, M30 (zinc plated, A2, A4, HCR)

- Materials, dimensions and mechanical properties see Table A1
- Inspection certificate 3.1 acc. to EN 10204:2004

Washer with bore and reducing adapter for filling the gap between threaded rod and fixture

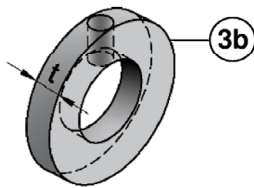

Thickness of washer with bore for diameter
< M24: $t = 5$ mm
 \geq M24: $t = 6$ mm

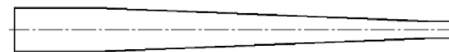

Internally threaded anchor rod

VMU-IG M6, VMU-IG M8, VMU-IG M10, VMU-IG M12, VMU-IG M16, VMU-IG M20
(zinc plated, A4, HCR)

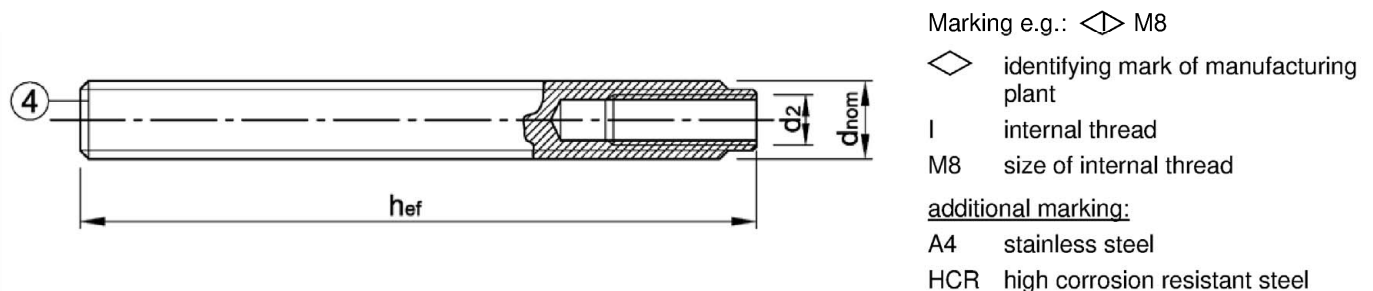

Injection system VMU plus for concrete

Product description

Threaded rods and internally threaded anchor rod

Annex A3

Table A1: Materials - Threaded rod and internally threaded anchor rod

Part	Designation	Material						
Steel, zinc plated electroplated $\geq 5 \mu\text{m}$ acc. to EN ISO 4042:2018 or hot-dip galvanized $\geq 40 \mu\text{m}$ (50 μm in average) acc. to EN ISO 1461:2009, EN ISO 10684:2004+AC:2009 or sherardized $\geq 45 \mu\text{m}$ acc. to EN ISO 17668:2016								
1	Threaded rod	property class	characteristic ultimate strength		characteristic yield strength		fracture elongation	EN ISO 683-4:2018, EN 10263:2001; Commercial standard threaded rod: EN ISO 898-1:2013
		4.6	f_{uk} [N/mm ²]	400	f_{yk} [N/mm ²]	240	$A_5 > 8 \%$	
		4.8		400		320	$A_5 > 8 \%$	
		5.6		500		300	$A_5 > 8 \%$	
		5.8		500		400	$A_5 > 8 \%$	
8.8	800	640		$A_5 > 8 \%$				
2	Hexagon nut	4	for class 4.6 or 4.8 rods					EN ISO 898-2:2012
		5	for class 4.6, 4.8, 5.6 or 5.8 rods					
		8	for class 4.6, 4.8, 5.6, 5.8 or 8.8 rods					
3a	Washer	e.g.: EN ISO 7089:2000, EN ISO 7093:2000, EN ISO 7094:2000, EN ISO 887:2006						
3b	Washer with bore	steel, zinc plated						
4	Internally threaded anchor rod	5.8	steel, electroplated or sherardized			$A_5 > 8 \%$	EN ISO 683-4:2018	
		8.8				$A_5 > 8 \%$		
Stainless steel A2 ¹⁾		CRC II (1.4301 / 1.4307 / 1.4311 / 1.4567 / 1.4541)						
Stainless steel A4		CRC III (1.4401 / 1.4404 / 1.4571 / 1.4578)						
High corrosion resistant steel HCR		CRC V (1.4529 / 1.4565)						
1	Threaded rod ²⁾	property class	characteristic ultimate strength		characteristic yield strength		fracture elongation	EN 10088-1:2014 EN ISO 3506-1:2020
		50	f_{uk} [N/mm ²]	500	f_{yk} [N/mm ²]	210	$A_5 > 8 \%$	
		70		700		450	$A_5 > 8 \%$	
80	800	600		$A_5 > 8 \%$				
2	Hexagon nut ²⁾	50	for class 50 rods					EN 10088-1:2014 EN ISO 3506-2:2020
		70	for class 50 or 70 rods					
		80	for class 50, 70 or 80 rods					
3a	Washer	e.g.: EN ISO 7089:2000, EN ISO 7093:2000, EN ISO 7094:2000; EN ISO 887:2006					EN 10088-1:2014	
3b	Washer with bore	stainless steel A4; high corrosion resistant steel HCR						
4	Internally threaded anchor rod	50	IG-M20			$A_5 > 8 \%$	EN 10088-1:2014	
		70	IG-M6 to IG-M16			$A_5 > 8 \%$		

¹⁾ for property classes 50 and 70

²⁾ property classes 70 and 80 up to M24

Injection system VMU plus for concrete

Product description
Materials threaded rods and internally threaded anchor rod

Annex A4

Reinforcing bar

Ø 8, Ø 10, Ø 12, Ø 14, Ø 16, Ø 20, Ø 25, Ø 28, Ø 32

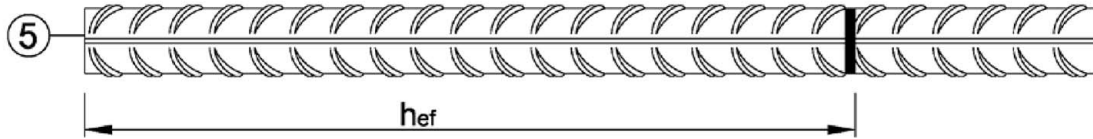

- Minimum value of related rip area $f_{R,min}$ according to EN 1992-1-1:2004+AC:2010
- Rip height of the bar shall be in the range $0,05d \leq h \leq 0,07d$
(d: Nominal diameter of the bar; h: Rip height of the bar)

Table A1: Material rebar

Part	Designation	Material
Rebar		
5	Rebar EN 1992-1-1:2004+AC:2010, Annex C	Bars and de-coiled rods class B or C f_{yk} and k according to NDP or NCL acc. EN 1992-1-1/NA $f_{uk} = f_{tk} = k \cdot f_{yk}$

Injection system VMU plus for concrete

Product description
Product description and materials reinforcing bar

Annex A5

Specification of intended use

Injection System VMU plus	Threaded rod	Internally threaded anchor rod	Rebar
Static and quasi-static action	M8 - M30	IG-M6 - IG-M20 (zinc plated, A4, HCR)	Ø8 - Ø32
Seismic action, performance category C1	M8 - M30	-	Ø8 - Ø32
Base materials	compacted, reinforced or unreinforced normal weight concrete (without fibers), acc. to EN 206:2013 + A1:2016 strength classes C20/25 to C50/60 acc. to EN 206-1:2013+A1:2016 cracked and uncracked concrete		
Temperature Range I -40°C to +40°C	max long term temperature +24 °C and max short term temperature +40°C		
Temperature Range II -40°C to +80°C	max long term temperature +50 °C and max short term temperature +80°C		
Temperature Range III -40°C to 120°C	max long term temperature +72 °C and max short term temperature +120°C		

Use conditions (Environmental conditions):

- Structures subject to dry internal conditions (all materials).
- For all other conditions:
Intended use of Material according to Annx A4, Table A1 corresponding corrosion resistance classes CRC according to EN 1993-1-4:2006 +A1:2015

Design:

- Verifiable calculation notes and drawings are prepared taking account of the loads to be anchored. The position of the anchor is indicated on the design drawings (e. g. position of the anchor relative to reinforcement or to supports, etc.)
- Anchorage are designed under the responsibility of an engineer experienced in anchorages and concrete work
- Anchorage are designed in accordance with EN 1992-4:2018 and Technical Report TR 055, Edition February 2018

Installation:

- Dry or wet concrete: M8 to M30, IG-M6 to IG-M20, Rebar Ø8 to Ø32
- Waterfilled holes (not sea water): M8 to M16, IG-M6 to IG-M10, Rebar Ø8 to Ø16
- Hole drilling by hammer or compressed air drill mode or vacuum drill mode
- Installation direction D3: downwards, horizontally and upwards (overhead) installation
- Anchor installation carried out by appropriately qualified personnel and under the supervision of the person responsible for technical matters of the site
- The injection mortar is assessed for installation at minimum concrete temperature of -10°C resp. -20°C, where subsequently the temperature in the concrete does not rise at a rapid rate, i.e. from the minimum installation temperature to 24°C within a 12-hour period.
- Internally threaded anchor rod: screws and threaded rods (incl. nut and washer) must at least correspond to the material and strength class of the internally threaded anchor rod used

Injection system VMU plus for concrete

Intended Use
Specifications

Annex B1

Table B1: Installation parameters for threaded rod

Threaded rod			M8	M10	M12	M16	M20	M24	M27	M30
Diameter threaded rod	$d=d_{nom}$	[mm]	8	10	12	16	20	24	27	30
Nominal drill hole diameter	d_0	[mm]	10	12	14	18	24	28	32	35
Effective anchorage depth	$h_{ef,min}$	[mm]	60	60	70	80	90	96	108	120
	$h_{ef,max}$	[mm]	160	200	240	320	400	480	540	600
Diameter of clearance hole in the fixture	Pre-setting installation $d_f \leq$	[mm]	9	12	14	18	22	26	30	33
	Through setting installation $d_f \leq$	[mm]	12	14	16	20	25	30	33	38
Installation torque	$\max T_{inst} \leq$	[Nm]	10	20	40 (35) ¹⁾	80	120	160	180	200
Minimum thickness of member	h_{min}	[mm]	$h_{ef} + 30mm \geq 100mm$			$h_{ef} + 2d_0$				
Minimum spacing	s_{min}	[mm]	40	50	60	80	100	120	135	150
Minimum edge distance	c_{min}	[mm]	40	50	60	80	100	120	135	150

¹⁾ max. installation torque for property class 4.6

Table B2: Installation parameters for internally threaded anchor rod

Internally threaded anchor rod			IG-M 6	IG-M 8	IG-M 10	IG-M 12	IG-M 16	IG-M 20
Inner diameter of threaded rod	d_2	[mm]	6	8	10	12	16	20
Outer diameter of threaded rod ¹⁾	$d=d_{nom}$	[mm]	10	12	16	20	24	30
Nominal drill hole diameter	d_0	[mm]	12	14	18	24	28	35
Effective anchorage depth	$h_{ef,min}$	[mm]	60	70	80	90	96	120
	$h_{ef,max}$	[mm]	200	240	320	400	480	600
Diameter of clearance hole in the fixture	$d_f \leq$	[mm]	7	9	12	14	18	22
Installation torque	$\max T_{inst} \leq$	[Nm]	10	10	20	40	60	100
Minimum screw-in depth	l_G	[mm]	8	8	10	12	16	20
Minimum thickness of member	h_{min}	[mm]	$h_{ef} + 30 mm \geq 100 mm$			$h_{ef} + 2d_0$		
Minimum spacing	s_{min}	[mm]	50	60	80	100	120	150
Minimum edge distance	c_{min}	[mm]	50	60	80	100	120	150

¹⁾ with metric thread acc. to EN 1993-1-8:2005+AC:2009

Table B3: Installation parameters for rebar







Rebar			Ø 8	Ø 10	Ø 12	Ø 14	Ø 16	Ø 20	Ø 25	Ø 28	Ø 32
Diameter threaded rod	$d=d_{nom}$	[mm]	8	10	12	14	16	20	24	28	32
Nominal drill hole diameter	d_0	[mm]	12	14	16	18	20	24	32	35	40
Effective anchorage depth	$h_{ef,min}$	[mm]	60	60	70	75	80	90	100	112	128
	$h_{ef,max}$	[mm]	160	200	240	280	320	400	500	560	640
Minimum thickness of member	h_{min}	[mm]	$h_{ef} + 30 mm \geq 100 mm$			$h_{ef} + 2d_0$					
Minimum spacing	s_{min}	[mm]	40	50	60	70	80	100	125	140	160
Minimum edge distance	c_{min}	[mm]	40	50	60	70	80	100	125	140	160

Injection system VMU plus for concrete

Intended Use
Installation parameters

Annex B2

Table B4: Parameter cleaning and setting tools

Threaded rod	Internally threaded anchor rod	Rebar	Drill bit \varnothing	Brush \varnothing	min. Brush \varnothing	Retaining washer			
						Installation direction and use of retaining washer			
[-]	[-]	\varnothing [mm]	d_0 [mm]	d_b [mm]	$d_{b,min}$ [mm]	[-]	↓	→	↑
M8			10	12	10,5	No retaining washer required			
M10	VMU-IG M 6	8	12	14	12,5				
M12	VMU-IG M 8	10	14	16	14,5				
		12	16	18	16,5				
M16	VMU-IG M10	14	18	20	18,5	VM-IA 18	$h_{ef} > 250\text{mm}$	$h_{ef} > 250\text{mm}$	all
		16	20	22	20,5	VM-IA 20			
M20	VMU-IG M12	20	24	26	24,5	VM-IA 24			
M24	VMU-IG M16		28	30	28,5	VM-IA 28			
M27		25	32	34	32,5	VM-IA 32			
M30	VMU-IG M20	28	35	37	35,5	VM-IA 35			
		32	40	41,5	40,5	VM-IA 40			

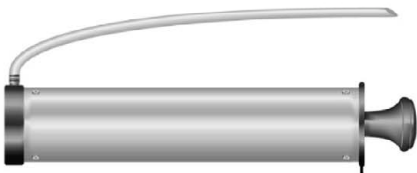

Blow-out pump (volume 750ml)
Drill bit diameter (d_0): 10 mm to 20 mm
Anchorage depth (h_{ef}): $\leq 10 d_{nom}$
for uncracked concrete



Recommended compressed air tool (min 6 bar)
All applications



Retaining washer for overhead or horizontal installation
Drill bit diameter (d_0):
18 mm to 40 mm



Steel brush
Drill bit diameter (d_0): all diameters

Injection system VMU plus for concrete

Intended Use
Cleaning and setting tools

Annex B3

Installation instructions

Drilling of the hole

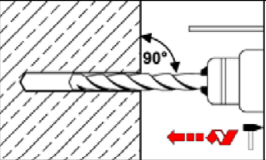
1		<p>Drill the hole by applying the drilling method acc. to Annex B1, the drill bit diameter (Table B4) and the selected drill hole depth. In case of aborted hole, the drill hole shall be filled with mortar</p>
---	-----------------------------------------------------------------------------------	----------------------------------------------------------------------------------------------------------------------------------------------------------------------------------------------------------------------

Cleaning, all drilling methods

Attention! Standing water in the drill hole must be removed before cleaning!

Cleaning with compressed air

(all diameters, cracked and uncracked concrete)

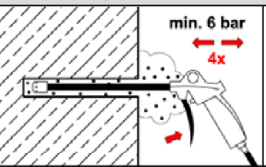
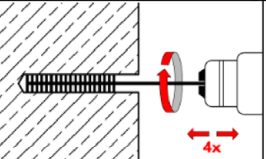
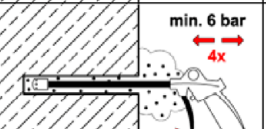
2a		<p>Starting from the bottom or back of the drill hole, blow out the hole with compressed air (min. 6 bar) four times, until return air stream is free of noticeable dust. If the drill hole ground is not reached, an extension must be used.</p>
2b		<p>Brush the hole with an appropriate sized wire brush $> d_{b,min}$ (Table B4) four times. If the drill hole ground is not reached, a brush extension shall be used.</p>
2c		<p>Finally blow the hole clean again with compressed air (min. 6 bar) four times, until the outgoing airstream is free of dust. If the drill hole ground is not reached an extension shall be used.</p>

2

Manual cleaning

uncracked concrete: Drill hole diameter $d_0 \leq 20\text{mm}$ and effective anchorage depth $h_{ef} \leq 10 d_{nom}$

cracked concrete: Drill hole diameter: $14\text{mm} \leq d_0 \leq 20\text{mm}$ and effective anchorage depth $h_{ef} \leq 10 d_{nom}$

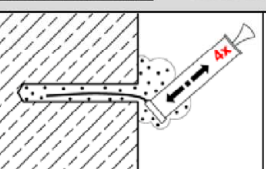
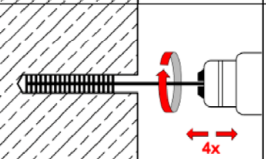
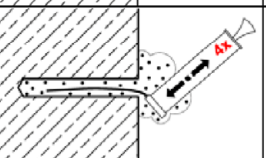
2a		<p>Starting from the bottom or back of the drill hole, blow the hole clean with the blow-out pump four times until return air stream is free of noticeable dust.</p>
2b		<p>Brush the hole four times with an appropriate sized wire brush $> d_{b,min}$ (Table B4). If the drill hole ground is not reached, a brush extension shall be used.</p>
2c		<p>Finally blow the hole clean again with the blow-out pump four times until return air stream is free of noticeable dust.</p>



After cleaning, the drill hole has to be protected against re-contamination in an appropriate way, until dispensing the mortar in the drill hole. If necessary, the cleaning has to be repeated directly before dispensing the mortar. In-flowing water must not contaminate the drill hole again.

Injection system VMU plus for concrete

Intended Use
Installation instructions

Annex B4

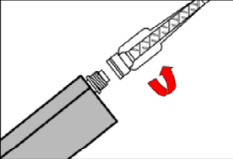
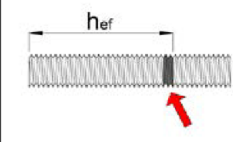
Installation instructions (continuation)

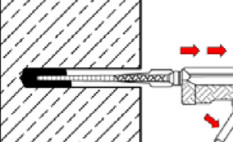
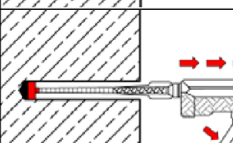
Injection		
3		Attach a supplied static-mixing nozzle to the cartridge and load the cartridge into the correct dispensing tool. For every working interruption longer than the recommended working time (Table B5 or Table B6) as well as for new cartridges, a new static-mixer shall be used.
4		Before injecting the mortar, mark the required anchorage depth on the fastening element.
5		Prior to dispensing into the drill hole, squeeze out separately a minimum of three full strokes and discard non-uniformly mixed adhesive components until the mortar shows a consistent grey colour. For tubular film cartridges dismiss a minimum of six full strokes.
6a		Starting from the bottom or back of the cleaned drill hole fill the hole up to approximately two-thirds with adhesive. Slowly withdraw the static mixing nozzle as the hole fills to avoid air pockets. For embedment larger than 190mm an extension nozzle shall be used. Observe the gel-/ working times given in Table B5 or Table B6.
6b		Retaining washer and mixer nozzle extensions shall be used according to Annex B3 for the following applications: <ul style="list-style-type: none"> • Horizontal installation (horizontal direction) and ground installation (vertical downwards direction): Drill bit-Ø $d_0 \geq 18$ mm and embedment depth $h_{ef} > 250$mm • Overhead installation: Drill bit-Ø $d_0 \geq 18$ mm

Injection system VMU plus for concrete

Intended Use
Installation instructions (continuation)

Annex B5

Installation instructions (continuation)

Setting the fastening element

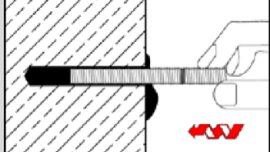
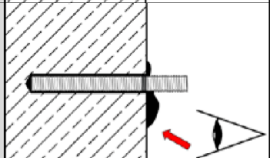
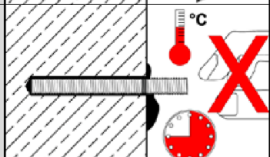
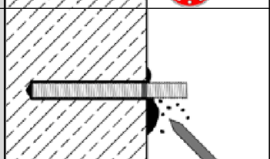
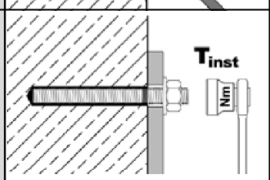
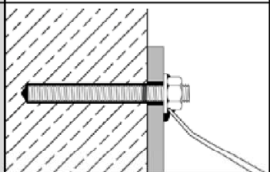
7		<p>Push fastening element into the hole while turning slightly to ensure proper distribution of the adhesive until the embedment depth is reached. The anchor shall be free of dirt, grease, oil or other foreign material.</p>
8		<p>Make sure that the fastening element is fully seated up to the full embedment depth and that excess mortar is visible at the top of the hole. If these requirements are not maintained, the application has to be renewed before the end of the working time. For overhead installation, the anchor should be fixed (e.g. by wedges).</p>
9		<p>Allow the adhesive to cure to the specified time prior to applying any load or torque. Do not move or load the anchor until it is fully cured (Table B5 or Table B6).</p>
10		<p>Remove excess mortar.</p>
11		<p>The fixture can be mounted after curing time. Apply installation torque $\leq T_{inst}$ according to Table B1 or B2.</p>
12		<p>Optionally, for pre-setting installation, the annular gap between anchor rod and attachment can be filled with mortar. Therefore replace the regular washer by washer with drill and plug on reducing adapter on static mixer. Annular gap is completely filled, when excess mortar seeps out.</p>

Injection system VMU plus for concrete

Intended Use
Installation instructions (continuation)

Annex B6

Table B5: Maximum processing time and minimum curing time, VMU plus

Concrete temperature	Maximum processing time	Minimum curing time in dry concrete ¹⁾
- 10°C to - 6°C	90 min ²⁾	24 h ²⁾
- 5°C to - 1°C	90 min	14 h
0°C to + 4°C	45 min	7 h
+ 5°C to + 9°C	25 min	2 h
+ 10°C to + 19°C	15 min	80 min
+ 20°C to + 29°C	6 min	45 min
+ 30°C to + 34°C	4 min	25 min
+ 35°C to + 39°C	2 min	20 min
+ 40°C	1,5 min	15 min
Cartridge temperature	+ 5°C to + 40°C	

¹⁾ in wet concrete the curing time must be doubled

²⁾ cartridge temperature must be at min. +15°C

Table B6: Maximum processing time and minimum curing time, VMU plus Polar

Concrete temperature	Maximum processing time	Minimum curing time in dry concrete ¹⁾
- 20°C to - 16°C	75 min	24 h
- 15°C to - 11°C	55 min	16 h
- 10°C to - 6°C	35 min	10 h
- 5°C to - 1°C	20 min	5 h
0°C to + 4°C	10 min	2,5 h
+ 5°C to + 9°C	6 min	80 min
+10°C	6 min	60 min
Cartridge temperature	- 20°C to + 10°C	

¹⁾ in wet concrete the curing time must be doubled

Injection system VMU plus for concrete

Intended Use
Processing time and curing time

Annex B7

Table C1: Characteristic steel resistances for threaded rods under tension loads

Threaded rod				M8	M10	M12	M16	M20	M24	M27	M30
Steel failure											
Cross sectional area A_s [mm ²]				36,6	58,0	84,3	157	245	353	459	561
Characteristic resistance under tension load ¹⁾											
Steel, zinc plated	Property class 4.6 and 4.8	$N_{Rk,s}$	[kN]	15 (13)	23 (21)	34	63	98	141	184	224
	Property class 5.6 and 5.8	$N_{Rk,s}$	[kN]	18 (17)	29 (27)	42	78	122	176	230	280
	Property class 8.8	$N_{Rk,s}$	[kN]	29 (27)	46 (43)	67	125	196	282	368	449
Stainless steel	A2, A4 and HCR Property class 50	$N_{Rk,s}$	[kN]	18	29	42	79	123	177	230	281
	A2, A4 and HCR Property class 70	$N_{Rk,s}$	[kN]	26	41	59	110	171	247	_ ³⁾	_ ³⁾
	A4 and HCR Property class 80	$N_{Rk,s}$	[kN]	29	46	67	126	196	282	_ ³⁾	_ ³⁾
Partial factors ²⁾											
Steel, zinc plated	Property class 4.6	$\gamma_{Ms,N}$	[-]	2,0							
	Property class 4.8	$\gamma_{Ms,N}$	[-]	1,5							
	Property class 5.6	$\gamma_{Ms,N}$	[-]	2,0							
	Property class 5.8	$\gamma_{Ms,N}$	[-]	1,5							
	Property class 8.8	$\gamma_{Ms,N}$	[-]	1,5							
Stainless steel	A2, A4 and HCR Property class 50	$\gamma_{Ms,N}$	[-]	2,86							
	A2, A4 and HCR Property class 70	$\gamma_{Ms,N}$	[-]	1,87						_ ³⁾	_ ³⁾
	A4 and HCR Property class 80	$\gamma_{Ms,N}$	[-]	1,6						_ ³⁾	_ ³⁾

¹⁾ the characteristic resistances apply for all anchor rods with the cross sectional area A_s specified here: VMU-A, V-A, VM-A
For commercial standard threaded rods with a smaller cross sectional area (e.g. hot-dip galvanized threaded rods M8, M10 according to EN ISO 10684:2004 + AC:2009), the values in brackets are valid.

²⁾ in absence of national regulation

³⁾ Anchor type not part of the ETA

Injection system VMU plus for concrete

Performance
Characteristic steel resistances for **threaded rods** under **tension loads**

Annex C1

Table C2: Characteristic steel resistances for threaded rods under shear loads

Threaded rod				M8	M10	M12	M16	M20	M24	M27	M30
Steel failure											
Cross sectional area A_s [mm ²]				36,6	58,0	84,3	157	245	353	459	561
Characteristic resistance under shear load ¹⁾											
Steel failure <u>without</u> lever arm											
Steel, zinc plated	Property class 4.6 and 4.8	$V^0_{Rk,s}$	[kN]	9 (8)	14 (13)	20	38	59	85	110	135
	Property class 5.6 and 5.8	$V^0_{Rk,s}$	[kN]	11 (10)	17 (16)	25	47	74	106	138	168
	Property class 8.8	$V^0_{Rk,s}$	[kN]	15 (13)	23 (21)	34	63	98	141	184	224
Stainless steel	A2, A4 and HCR, property class 50	$V^0_{Rk,s}$	[kN]	9	15	21	39	61	88	115	140
	A2, A4 and HCR, property class 70	$V^0_{Rk,s}$	[kN]	13	20	30	55	86	124	.. ³⁾	.. ³⁾
	A4 and HCR, property class 80	$V^0_{Rk,s}$	[kN]	15	23	34	63	98	141	.. ³⁾	.. ³⁾
Steel failure <u>with</u> lever arm											
Steel, zinc plated	Property class 4.6 and 4.8	$M^0_{Rk,s}$	[Nm]	15 (13)	30 (27)	52	133	260	449	666	900
	Property class 5.6 and 5.8	$M^0_{Rk,s}$	[Nm]	19 (16)	37 (33)	65	166	324	560	833	1123
	Property class 8.8	$M^0_{Rk,s}$	[Nm]	30 (26)	60 (53)	105	266	519	896	1333	1797
Stainless steel	A2, A4 and HCR, property class 50	$M^0_{Rk,s}$	[Nm]	19	37	66	167	325	561	832	1125
	A2, A4 and HCR, property class 70	$M^0_{Rk,s}$	[Nm]	26	52	92	232	454	784	.. ³⁾	.. ³⁾
	A4 and HCR, property class 80	$M^0_{Rk,s}$	[Nm]	30	59	105	266	519	896	.. ³⁾	.. ³⁾
Partial factor ²⁾											
Steel, zinc plated	Property class 4.6	$\gamma_{Ms,V}$	[-]	1,67							
	Property class 4.8	$\gamma_{Ms,V}$	[-]	1,25							
	Property class 5.6	$\gamma_{Ms,V}$	[-]	1,67							
	Property class 5.8	$\gamma_{Ms,V}$	[-]	1,25							
	Property class 8.8	$\gamma_{Ms,V}$	[-]	1,25							
Stainless steel	A2, A4 and HCR, property class 50	$\gamma_{Ms,V}$	[-]	2,38							
	A2, A4 and HCR, property class 70	$\gamma_{Ms,V}$	[-]	1,56						.. ³⁾	.. ³⁾
	A4 and HCR, property class 80	$\gamma_{Ms,V}$	[-]	1,33						.. ³⁾	.. ³⁾

¹⁾ the characteristic resistances apply for all anchor rods with the cross sectional area A_s specified here: VMU-A, V-A, VM-A
For commercial standard threaded rods with a smaller cross sectional area (e.g. hot-dip galvanized threaded rods M8, M10 according to EN ISO 10684:2004 + AC:2009), the values in brackets are valid.

²⁾ in absence of national regulation

³⁾ Anchor type not part of the ETA

Injection system VMU plus for concrete

Performance

Characteristic steel resistances for **threaded rods** under **tension loads**

Annex C2

Table C3: Characteristic values for **concrete cone** and **splitting failure**

Threaded rods / Internally threaded anchor rods / Rebars				all sizes
Concrete cone failure				
Factor k_1	uncracked concrete	$k_{Ucr,N}$	[-]	11,0
	cracked concrete	$k_{Cr,N}$	[-]	7,7
Edge distance		$c_{Cr,N}$	[mm]	$1,5 \cdot h_{ef}$
Spacing		$s_{Cr,N}$	[mm]	$2 \cdot c_{Cr,N}$
Splitting failure				
Characteristic resistance		$N^0_{RK,sp}$	[kN]	$\min (N_{RK,p} ; N^0_{RK,c})$
Edge distance	$h/h_{ef} \geq 2,0$	$c_{Cr,sp}$	[mm]	$1,0 \cdot h_{ef}$
	$2,0 > h/h_{ef} > 1,3$			$2 \cdot h_{ef} (2,5 - h / h_{ef})$
	$h/h_{ef} \leq 1,3$			$2,4 \cdot h_{ef}$
Spacing		$s_{Cr,sp}$	[mm]	$2 \cdot c_{Cr,sp}$

Injection system VMU plus for concrete

Performance
Characteristic values for **concrete cone** and **splitting failure**

Annex C3

Table C4: Characteristic values for threaded rods under tension loads

Threaded rod			M8	M10	M12	M16	M20	M24	M27	M30		
Steel failure												
Characteristic resistance			$N_{Rk,s}$	[kN]	$A_s \cdot f_{uk}$ (or see Table C1)							
Partial factor			$\gamma_{Ms,N}$	[-]	see Table C1							
Combined pull-out and concrete failure												
Characteristic bond resistance in <u>uncracked</u> concrete C20/25												
Temperature range	I: 40°C/24°C	dry or wet concrete	$\tau_{Rk,ucr}$	[N/mm ²]	10	12	12	12	12	11	10	9
	II: 80°C/50°C				7,5	9	9	9	9	8,5	7,5	6,5
	III: 120°C/72°C				5,5	6,5	6,5	6,5	6,5	6,5	5,5	5,0
	I: 40°C/24°C	waterfilled drill hole	$\tau_{Rk,ucr}$	[N/mm ²]	7,5	8,5	8,5	8,5	no performance assessed			
	II: 80°C/50°C				5,5	6,5	6,5	6,5				
	III: 120°C/72°C				4,0	5,0	5,0	5,0				
Characteristic bond resistance in <u>cracked</u> concrete C20/25												
Temperature range	I: 40°C/24°C	dry or wet concrete	$\tau_{Rk,cr}$	[N/mm ²]	4,0	5,0	5,5	5,5	5,5	5,5	6,5	6,5
	II: 80°C/50°C				2,5	3,5	4,0	4,0	4,0	4,0	4,5	4,5
	III: 120°C/72°C				2,0	2,5	3,0	3,0	3,0	3,0	3,5	3,5
	I: 40°C/24°C	waterfilled drill hole	$\tau_{Rk,cr}$	[N/mm ²]	4,0	4,0	5,5	5,5	no performance assessed			
	II: 80°C/50°C				2,5	3,0	4,0	4,0				
	III: 120°C/72°C				2,0	2,5	3,0	3,0				
Reductionfactor ψ^0_{sus} in concrete C20/25												
Temperature range	I: 40°C/24°C	dry or wet concrete; waterfilled drill hole	ψ^0_{sus}	[-]	0,73							
	II: 80°C/50°C				0,65							
	III: 120°C/72°C				0,57							
Increasing factors for τ_{Rk}			ψ_c	[-]	C25/30						1,02	
					C30/37						1,04	
					C35/45						1,07	
					C40/50						1,08	
					C45/55						1,09	
					C50/60						1,10	
Concrete cone failure												
Relevant parameter			see Table C3									
Splitting failure												
Relevant parameter			see Table C3									
Installation factor												
dry or wet concrete			γ_{inst}	[-]	1,0	1,2						
waterfilled drill hole			γ_{inst}	[-]	1,4			no performance assessed				

Injection system VMU plus for concrete

Performance
Characteristic values for **threaded rods** under **tension loads**

Annex C4

Table C5: Characteristic values for threaded rods under shear loads

Threaded rod			M8	M10	M12	M16	M20	M24	M27	M30	
Steel failure without lever arm											
Characteristic resistance, steel zinc plated, property class 4.6, 4.8, 5.6, 5.8	$V_{Rk,s}^0$	[kN]	0,6 · A _s · f _{uk} (or see table C2)								
Characteristic resistance, steel zinc plated, property class 8.8, stainless steel A2 / A4 / HCR, all property classes	$V_{Rk,s}^0$	[kN]	0,5 · A _s · f _{uk} (or see table C2)								
Ductility factor	k ₇	[-]	1,0								
Partial factor	γ _{Ms,V}	[-]	see Table C2								
Steel failure with lever arm											
Characteristic bending moment	$M_{Rk,s}^0$	[Nm]	1,2 · W _{el} · f _{uk} (or see table C2)								
Elastic section modulus	W _{el}	[mm ³]	31	62	109	277	541	935	1387	1874	
Partial factor	γ _{Ms,V}	[-]	see table C2								
Concrete pry-out failure											
Pry-out Factor	k ₈	[-]	2,0								
Concrete edge failure											
Effective length of anchor	l _f	[mm]	min(h _{ef} ; 12 d _{nom})							min (h _{ef} ; 300mm)	
Outside diameter of anchor	d _{nom}	[mm]	8	10	12	16	20	24	27	30	
Installation factor	γ _{inst}	[-]	1,0								

Injection system VMU plus for concrete

Performance
Characteristic value for **threaded rods** under **shear loads**

Annex C5

Table C6: Characteristic values for threaded rods under tension load, seismic action, performance category C1

Threaded rod				M8	M10	M12	M16	M20	M24	M27	M30	
Steel failure												
Characteristic resistance				$N_{Rk,s,C1}$	[kN]		$1,0 \cdot N_{Rk,s}$					
Partial factor				$\gamma_{Ms,V}$	[-]		see Table C1					
Combined pull-out and concrete failure												
Characteristic bond resistance in concrete C20/25 to C50/60												
Temperature range	I: 40°C/24°C	dry or wet concrete	$\tau_{Rk,C1}$	[N/mm ²]	2,5	3,1	3,7	3,7	3,7	3,8	4,5	4,5
	II: 80°C/50°C				1,6	2,2	2,7	2,7	2,7	2,8	3,1	3,1
	III: 120°C/72°C				1,3	1,6	2,0	2,0	2,0	2,1	2,4	2,4
	I: 40°C/24°C	waterfilled drill hole	$\tau_{Rk,C1}$	[N/mm ²]	2,5	2,5	3,7	3,7	no performance assessed			
	II: 80°C/50°C				1,6	1,9	2,7	2,7				
	III: 120°C/72°C				1,3	1,6	2,0	2,0				
Installation factor												
Dry or wet concrete				γ_{inst}	[-]		1,0	1,2				
Waterfilled drill hole				γ_{inst}	[-]		1,4			no performance assessed		

Table C7: Characteristic values for threaded rods under shear load, seismic action, performance category C1

Threaded rod				M8	M10	M12	M16	M20	M24	M27	M30
Steel failure											
Characteristic resistance				$V_{Rk,s,C1}$	[kN]		$0,7 \cdot V^0_{Rk,s}$				
Partial factor				$\gamma_{Ms,V}$	[-]		See Table C2				
Factor for annular gap											
Factor for anchorages	without hole clearance		α_{gap}	[-]		1,0					
	with hole clearance between fastener and fixture		α_{gap}	[-]		0,5					

Injection system VMU plus for concrete

Performance
Characteristic values for **threaded rods** under **seismic action**, category **C1**

Annex C6

Table C8: Characteristic values of tension loads for internally threaded anchor rods

Internally threaded anchor rod				IG-M 6	IG-M 8	IG-M 10	IG-M 12	IG-M 16	IG-M 20	
Steel failure ¹⁾										
Characteristic resistance,	5.8	$N_{Rk,s}$	[kN]	10	17	29	42	76	123	
steel zinc plated, strength class	8.8	$N_{Rk,s}$	[kN]	16	27	46	67	121	196	
Partial factor		$\gamma_{Ms,N}$	[-]	1,5						
Characteristic resistance,		$N_{Rk,s}$	[kN]	14	26	41	59	110	124 ²⁾	
stainless steel A4 / HCR, strength class 70										
Partial factor		$\gamma_{Ms,N}$	[-]	1,87					2,86	
Combined pull-out and concrete cone failure										
Characteristic bond resistance in uncracked concrete C20/25										
Temperature range	I: 40°C/24°C	dry and wet concrete	$\tau_{Rk,ucr}$	[N/mm ²]	12	12	12	12	11	9,0
	II: 80°C/50°C			[N/mm ²]	9,0	9,0	9,0	9,0	8,5	6,5
	III: 120°C/72°C			[N/mm ²]	6,5	6,5	6,5	6,5	6,5	5,0
	I: 40°C/24°C	waterfilled drill hole	$\tau_{Rk,ucr}$	[N/mm ²]	8,5	8,5	8,5	no performance assessed		
	II: 80°C/50°C			[N/mm ²]	6,5	6,5	6,5			
	III: 120°C/72°C			[N/mm ²]	5,0	5,0	5,0			
Characteristic bond resistance in cracked concrete C20/25										
Temperature range	I: 40°C/24°C	dry and wet concrete	$\tau_{Rk,cr}$	[N/mm ²]	5,0	5,5	5,5	5,5	5,5	6,5
	II: 80°C/50°C			[N/mm ²]	3,5	4,0	4,0	4,0	4,0	4,5
	III: 120°C/72°C			[N/mm ²]	2,5	3,0	3,0	3,0	3,0	3,5
	I: 40°C/24°C	waterfilled drill hole	$\tau_{Rk,cr}$	[N/mm ²]	4,0	5,5	5,5	no performance assessed		
	II: 80°C/50°C			[N/mm ²]	3,0	4,0	4,0			
	III: 120°C/72°C			[N/mm ²]	2,5	3,0	3,0			
Reductionfactor ψ_{sus}^0 in concrete C20/25										
Temperature range	I: 40°C/24°C	dry and wet concrete	ψ_{sus}^0	[-]	0,73					
	II: 80°C/50°C				0,65					
	III: 120°C/72°C				0,57					
Increasing factors for τ_{Rk}				ψ_c	C25/30	1,02				
					C30/37	1,04				
					C35/45	1,07				
					C40/50	1,08				
					C45/55	1,09				
					C50/60	1,10				
Concrete cone failure and splitting failure										
Relevant parameter				see Table C3						
Installation factor										
dry and wet concrete		γ_{inst}	[-]	1,2						
waterfilled drill hole		γ_{inst}	[-]	1,4			no performance determined			
¹⁾ fastening screws or threaded rods (incl. nut and washer) must comply with the appropriate material and property class of the internally threaded anchor rod. The characteristic tension resistance for steel failure of the given strength class are valid for the internally threaded anchor rod and the fastening element.										
²⁾ for VMU-IG M20: Internally threaded rod: strength class 50; Fastening screws or threaded rods (incl. nut and washer): strength class 70										
Injection system VMU plus for concrete									Annex C7	
Performance Characteristic values for internally threaded anchor rods under tension loads										

Table C9: Characteristic values for internally threaded anchor rods under shear loads

Internally threaded anchor rod				IG-M 6	IG-M 8	IG-M 10	IG-M 12	IG-M 16	IG-M 20
Steel failure <u>without</u> lever arm¹⁾									
Characteristic resistance, steel zinc plated, strength class	5.8	$V_{Rk,s}^0$	[kN]	6	10	17	25	45	74
	8.8	$V_{Rk,s}^0$	[kN]	8	14	23	34	60	98
Partial factor		$\gamma_{Ms,V}$	[-]	1,25					
Characteristic resistance, stainless steel A4 / HCR, strength class	70	$V_{Rk,s}^0$	[kN]	7	13	20	30	55	62 ²⁾
		$\gamma_{Ms,V}$	[-]	1,56					
Ductility factor		k_7	[-]	1,0					
Steel failure <u>with</u> lever arm¹⁾									
Characteristic bending moment, steel zinc plated, strength class	5.8	$M_{Rk,s}^0$	[Nm]	8	19	37	66	167	325
	8.8	$M_{Rk,s}^0$	[Nm]	12	30	60	105	267	519
Partial factor		$\gamma_{Ms,V}$	[-]	1,25					
Characteristic bending resistance, stainless steel A4 / HCR, strength class	70	$M_{Rk,s}^0$	[Nm]	11	26	53	92	234	643 ²⁾
		$\gamma_{Ms,V}$	[-]	1,56					
Concrete pry-out failure									
Pry-out factor		k_8	[-]	2,0					
Concrete edge failure									
Effective length of anchor		l_f	[mm]	min(h_{ef} ; 12 d_{nom})					min (h_{ef} ; 300mm)
Outside diameter of anchor		d_{nom}	[mm]	10	12	16	20	24	30
Installation factor		γ_{inst}	[-]	1,0					

¹⁾ fastening screws or threaded rods (incl. nut and washer) must comply with the appropriate material and property class of the internally threaded anchor rod. The characteristic shear resistance for steel failure of the given strength class are valid for the internally threaded anchor rod and the fastening element

²⁾ for VMU-IG M20: Internally threaded rod: strength class 50; Fastening screws or threaded rods (incl. nut and washer): strength class 70

Injection system VMU plus for concrete

Performance
Characteristic values for **internally threaded anchor rods** under **shear loads**

Annex C8

Table C10: Characteristic values for rebar under tension loads

Rebar		Ø 8	Ø 10	Ø 12	Ø 14	Ø 16	Ø 20	Ø 25	Ø 28	Ø 32			
Steel failure													
Characteristic resistance		$N_{Rk,s}$	[kN]	$A_s \cdot f_{uk}^{1)}$									
Cross sectional area		A_s	[mm ²]	50	79	113	154	201	314	491	616	804	
Partial factor		$\gamma_{Ms,N}$	[-]	1,4 ²⁾									
Combined pull-out and concrete cone failure													
Characteristic bond resistance in uncracked concrete C20/25													
Temperature range	I: 40°C/24°C	dry and wet concrete	$\tau_{Rk,ucr}$	[N/mm ²]	10	12	12	12	12	12	11	10	8,5
	II: 80°C/50°C				7,5	9,0	9,0	9,0	9,0	9,0	8,0	7,0	6,0
	III: 120°C/72°C				5,5	6,5	6,5	6,5	6,5	6,5	6,0	5,0	4,5
	I: 40°C/24°C	waterfilled drill hole	$\tau_{Rk,ucr}$	[N/mm ²]	7,5	8,5	8,5	8,5	8,5	no performance assessed			
	II: 80°C/50°C				5,5	6,5	6,5	6,5	6,5				
	III: 120°C/72°C				4,0	5,0	5,0	5,0	5,0				
Characteristic bond resistance in cracked concrete C20/25													
Temperature range	I: 40°C/24°C	dry and wet concrete	$\tau_{Rk,cr}$	[N/mm ²]	4,0	5,0	5,5	5,5	5,5	5,5	5,5	6,5	6,5
	II: 80°C/50°C				2,5	3,5	4,0	4,0	4,0	4,0	4,0	4,5	4,5
	III: 120°C/72°C				2,0	2,5	3,0	3,0	3,0	3,0	3,0	3,5	3,5
	I: 40°C/24°C	waterfilled drill hole	$\tau_{Rk,cr}$	[N/mm ²]	4,0	4,0	5,5	5,5	5,5	no performance assessed			
	II: 80°C/50°C				2,5	3,0	4,0	4,0	4,0				
	III: 120°C/72°C				2,0	2,5	3,0	3,0	3,0				
Reductionfactor ψ_{sus}^0 in concrete C20/25													
Temperature range	I: 40°C/24°C	dry and wet concrete	ψ_{sus}^0	[-]	0,73								
	II: 80°C/50°C				0,65								
	III: 120°C/72°C				0,57								
Increasing factors for τ_{Rk}			ψ_c	[-]	C25/30	1,02							
					C30/37	1,04							
					C35/45	1,07							
					C40/50	1,08							
					C45/55	1,09							
					C50/60	1,10							
Concrete cone failure and splitting failure													
Relevant parameter		see Table C3											
Installation factor													
dry and wet concrete		γ_{inst}	[-]	1,0	1,2								
waterfilled drill hole		γ_{inst}	[-]	1,4				no performance assessed					

¹⁾ f_{uk} shall be taken from the specifications of reinforcing bars

²⁾ in absence of national regulation

Injection system VMU plus for concrete

Performance
Characteristic values for rebar under tension loads

Annex C9

Table C11: Characteristic values for rebar under shear load

Rebar		Ø 8	Ø 10	Ø 12	Ø 14	Ø 16	Ø 20	Ø 25	Ø 28	Ø 32
Steel failure without lever arm										
Characteristic resistance	$V_{Rk,s}^0$ [kN]	$0,50 \cdot A_s \cdot f_{uk}^{1)}$								
Cross sectional area	A_s [mm ²]	50	79	113	154	201	314	491	616	804
Partial factor	$\gamma_{Ms,V}$ [-]	1,5 ²⁾								
Ductility factor	k_7 [-]	1,0								
Steel failure with lever arm										
Characteristic bending moment	$M_{Rk,s}^0$ [Nm]	$1,2 \cdot W_{el} \cdot f_{uk}^{1)}$								
Elastic section modulus	W_{el} [mm ³]	50	98	170	269	402	785	1534	2155	3217
Partial factor	$\gamma_{Ms,V}$ [-]	1,5 ²⁾								
Concrete pry-out failure										
Factor	k_8 [-]	2,0								
Concrete edge failure										
Effective length of anchor	l_f [mm]	min(h_{ef} ; 12 d_{nom})						min(h_{ef} ; 300mm)		
Outside diameter of anchor	d_{nom} [mm]	8	10	12	14	16	20	25	28	32
Installation factor	γ_{inst} [-]	1,0								

¹⁾ f_{uk} shall be taken from the specifications of reinforcing bars

²⁾ in absence of national regulation

Injection system VMU plus for concrete

Performance
Characteristic values for rebar under shear load

Annex C10

Table C12: Characteristic values for rebar under seismic action, tension load
performance category **C1**

Rebar				Ø 8	Ø 10	Ø 12	Ø 14	Ø 16	Ø 20	Ø 25	Ø 28	Ø 32	
Steel failure													
Characteristic resistance		$N_{Rk,s,C1}$	[kN]	$A_s \cdot f_{uk}^{1)}$									
Cross sectional area		A_s	[mm ²]	50	79	113	154	201	314	491	616	804	
Partial factor		$\gamma_{Ms,N}$	[-]	1,4 ²⁾									
Combined pull-out and concrete cone failure													
Characteristic bond resistance in concrete C20/25 to C50/60													
Temperature range	I: 40°C/24°C	dry and wet concrete	$\tau_{Rk,C1}$	[N/mm ²]	2,5	3,1	3,7	3,7	3,7	3,7	3,8	4,5	4,5
	II: 80°C/50°C				1,6	2,2	2,7	2,7	2,7	2,7	2,8	3,1	3,1
	III: 120°C/72°C				1,3	1,6	2,0	2,0	2,0	2,0	2,1	2,4	2,4
	I: 40°C/24°C	waterfilled drill hole	$\tau_{Rk,C1}$	[N/mm ²]	2,5	2,5	3,7	3,7	3,7	no performance assessed			
	II: 80°C/50°C				1,6	1,9	2,7	2,7	2,7				
	III: 120°C/72°C				1,3	1,6	2,0	2,0	2,0				
Installation factor													
dry and wet concrete		γ_{inst}	[-]	1,0	1,2								
waterfilled drill hole		γ_{inst}	[-]	1,4					no performance assessed				

¹⁾ f_{uk} shall be taken from the specifications of reinforcing bars

²⁾ in absence of national regulation

Table C13: Characteristic values for rebar under seismic action, shear load,
performance category **C1**

Rebar				Ø 8	Ø 10	Ø 12	Ø 14	Ø 16	Ø 20	Ø 25	Ø 28	Ø 32	
Steel failure <u>without</u> lever arm													
Characteristic resistance		$V_{Rk,s,C1}$	[kN]	$0,35 \cdot A_s \cdot f_{uk}^{1)}$									
Cross sectional area		A_s	[mm ²]	50	79	113	154	201	314	491	616	804	
Partial factor		$\gamma_{Ms,V}$	[-]	1,5 ²⁾									
Ductility factor		k_7	[-]	1,0									

¹⁾ f_{uk} shall be taken from the specifications of reinforcing bars

²⁾ in absence of national regulation

Injection system VMU plus for concrete

Performance
Characteristic values for rebar under seismic action, category C1

Annex C11

Table C14: Displacement factor under tension loads¹⁾
(threaded rod and internally threaded anchor rod)

Threaded rod			M8	M10 IG-M6	M12 IG-M8	M16 IG- M10	M20 IG-M12	M24 IG-M16	M27	M30 IG-M20
Uncracked concrete C20/25, static and quasi-static action										
Temperature range I: 40°C/24°C	δ_{N0} -factor	$\frac{\text{mm}}{[\text{N}/\text{mm}^2]}$	0,021	0,023	0,026	0,031	0,036	0,041	0,045	0,049
	$\delta_{N\infty}$ -factor		0,030	0,033	0,037	0,045	0,052	0,060	0,065	0,071
Temperature range II: 80°C/50°C	δ_{N0} -factor		0,050	0,056	0,063	0,075	0,088	0,100	0,110	0,119
	$\delta_{N\infty}$ -factor		0,072	0,081	0,090	0,108	0,127	0,145	0,159	0,172
Temperature range III: 120°C/72°C	δ_{N0} -factor		0,050	0,056	0,063	0,075	0,088	0,100	0,110	0,119
	$\delta_{N\infty}$ -factor		0,072	0,081	0,090	0,108	0,127	0,145	0,159	0,172
Cracked concrete C20/25, static and quasi-static action										
Temperature range I: 40°C/24°C	δ_{N0} -factor	$\frac{\text{mm}}{[\text{N}/\text{mm}^2]}$	0,090		0,070					
	$\delta_{N\infty}$ -factor		0,105		0,105					
Temperature range II: 80°C/50°C	δ_{N0} -factor		0,219		0,170					
	$\delta_{N\infty}$ -factor		0,255		0,245					
Temperature range III: 120°C/72°C	δ_{N0} -factor		0,219		0,170					
	$\delta_{N\infty}$ -factor		0,255		0,245					

¹⁾ Calculation of the displacement

$$\delta_{N0} = \delta_{N0}\text{-factor} \cdot \tau; \quad \tau: \text{acting bond stress for tension load}$$

$$\delta_{N\infty} = \delta_{N\infty}\text{-factor} \cdot \tau;$$

Table C15: Displacement factor under shear load¹⁾
(threaded rod and internally threaded anchor rod)

Threaded rod			M8	M10 IG-M6	M12 IG-M8	M16 IG- M10	M20 IG-M12	M24 IG-M16	M27	M30 IG-M20
Uncracked concrete C20/25, static and quasi-static action										
All temperature ranges	δ_{V0} -factor	$\frac{\text{mm}}{[\text{N}/\text{mm}^2]}$	0,06	0,06	0,05	0,04	0,04	0,03	0,03	0,03
	$\delta_{V\infty}$ -factor		0,09	0,08	0,08	0,06	0,06	0,05	0,05	0,05
Cracked concrete C20/25, static and quasi-static action										
All temperature ranges	δ_{V0} -factor	$\frac{\text{mm}}{[\text{N}/\text{mm}^2]}$	0,12	0,12	0,11	0,10	0,09	0,08	0,08	0,07
	$\delta_{V\infty}$ -factor		0,18	0,18	0,17	0,15	0,14	0,13	0,12	0,10

¹⁾ Calculation of the displacement

$$\delta_{V0} = \delta_{V0}\text{-factor} \cdot V; \quad V: \text{acting shear load}$$

$$\delta_{V\infty} = \delta_{V\infty}\text{-factor} \cdot V;$$

Injection system VMU plus for concrete

Performance
Displacements (threaded rod and internally threaded anchor rod)

Annex C12

Table C16: Displacement factor under tension load¹⁾ (rebar)

Rebar		Ø 8	Ø 10	Ø 12	Ø 14	Ø 16	Ø 20	Ø 25	Ø 28	Ø 32	
Uncracked concrete C20/25, static and quasi-static action											
Temperature range I: 40°C/24°C	δ _{N0} -factor	mm [N/mm ²]	0,021	0,023	0,026	0,028	0,031	0,036	0,043	0,047	0,052
	δ _{N∞} -factor		0,030	0,033	0,037	0,041	0,045	0,052	0,061	0,071	0,075
Temperature range II: 80°C/50°C	δ _{N0} -factor		0,050	0,056	0,063	0,069	0,075	0,088	0,104	0,113	0,126
	δ _{N∞} -factor		0,072	0,081	0,090	0,099	0,108	0,127	0,149	0,163	0,181
Temperature range III: 120°C/72°C	δ _{N0} -factor		0,050	0,056	0,063	0,069	0,075	0,088	0,104	0,113	0,126
	δ _{N∞} -factor		0,072	0,081	0,090	0,099	0,108	0,127	0,149	0,163	0,181
Cracked concrete C20/25, static and quasi-static action											
Temperature range I: 40°C/24°C	δ _{N0} -factor	mm [N/mm ²]	0,090				0,070				
	δ _{N∞} -factor		0,105				0,105				
Temperature range II: 80°C/50°C	δ _{N0} -factor		0,219				0,170				
	δ _{N∞} -factor		0,255				0,245				
Temperature range III: 120°C/72°C	δ _{N0} -factor		0,219				0,170				
	δ _{N∞} -factor		0,255				0,245				

¹⁾ Calculation of the displacement

$$\delta_{N0} = \delta_{N0\text{-factor}} \cdot \tau; \quad \tau: \text{acting bond stress for tension load}$$

$$\delta_{N\infty} = \delta_{N\infty\text{-factor}} \cdot \tau;$$

Table C17: Displacement factor under shear load¹⁾ (rebar)

Rebar		Ø 8	Ø 10	Ø 12	Ø 14	Ø 16	Ø 20	Ø 25	Ø 28	Ø 32	
Uncracked concrete C20/25, static and quasi-static action											
All temperature ranges	δ _{V0} -factor	mm [N/mm ²]	0,06	0,05	0,05	0,04	0,04	0,04	0,03	0,03	0,03
	δ _{V∞} -factor		0,09	0,08	0,08	0,06	0,06	0,05	0,05	0,04	0,04
Cracked concrete C20/25, static and quasi-static action											
All temperature ranges	δ _{V0} -factor	mm [N/mm ²]	0,12	0,12	0,11	0,11	0,10	0,09	0,08	0,07	0,06
	δ _{V∞} -factor		0,18	0,18	0,17	0,16	0,15	0,14	0,12	0,11	0,10

¹⁾ Calculation of the displacement

$$\delta_{V0} = \delta_{V0\text{-factor}} \cdot V; \quad V: \text{acting shear load}$$

$$\delta_{V\infty} = \delta_{V\infty\text{-factor}} \cdot V;$$

Injection system VMU plus for concrete

Performance
Displacements (rebar)

Annex C13